

AREdu 2021 – Immersive technology today

Svitlana H. Lytvynova¹, Serhiy O. Semerikov^{1,2,3,4}, Andrii M. Striuk³,
Mykola I. Striuk³, Larisa S. Kolgatina⁵, Vladyslav Ye. Velychko⁶, Iryna S. Mintii^{1,2},
Olga O. Kalinichenko² and Serhii M. Tukalo¹

¹*Institute of Information Technologies and Learning Tools of the NAES of Ukraine, 9 M. Berlynskoho Str., Kyiv, 04060, Ukraine*

²*Kryvyi Rih State Pedagogical University, 54 Gagarin Ave., Kryvyi Rih, 50086, Ukraine*

³*Kryvyi Rih National University, 11 Vitalii Matusevych Str., Kryvyi Rih, 50027, Ukraine*

⁴*University of Educational Management, 52-A Sichovykh Striltsiv Str., Kyiv, 04053, Ukraine*

⁵*H. S. Skovoroda Kharkiv National Pedagogical University, 29 Alchevskiyh Str., Kharkiv, 61002, Ukraine*

⁶*Donbas State Pedagogical University, 19 Henerala Batiuka Str., Sloviansk, 64122, Ukraine*

Abstract

This is an introductory text to a collection of papers from the AREdu 2021: The 4th International Workshop on Augmented Reality in Education, which was held in Kryvyi Rih, Ukraine, on the May 11, 2021. It consists of short introduction, papers' review and some observations about the event and its future.

Keywords

virtualization of learning; principles, technologies, tools, augmented reality gamification, design and implementation of augmented reality learning environments, aspects of environmental augmented reality security and ethics, augmented reality in science education, augmented reality in professional training and retraining, augmented reality social and technical issues

AREdu 2021: 4th International Workshop on Augmented Reality in Education, May 11, 2021, Kryvyi Rih, Ukraine

✉ s.h.lytvynova@gmail.com (S. H. Lytvynova); semerikov@gmail.com (S. O. Semerikov);

andrey.n.stryuk@gmail.com (A. M. Striuk); stryukm@gmail.com (M. I. Striuk); larakl@ukr.net (L. S. Kolgatina);

vladislav.velichko@gmail.com (V. Ye. Velychko); irina.mintii@kdpu.edu.ua (I. S. Mintii);

olgakalinichenko6@gmail.com (O. O. Kalinichenko); serhii.tukalo@gmail.com (S. M. Tukalo)

🌐 <https://iitlt.gov.ua/eng/structure/detail.php?ID=998> (S. H. Lytvynova); <https://kdpu.edu.ua/semmerikov>

(S. O. Semerikov); <http://mpz.knu.edu.ua/pro-kafedru/vikladachi/224-andrii-striuk> (A. M. Striuk);

<http://hnpu.edu.ua/uk/kolgatina-larysa-sergiyivna> (L. S. Kolgatina); <https://ddpu.edu.ua/cc/velychko/>

(V. Ye. Velychko); <https://kdpu.edu.ua/personal/ismintii.html> (I. S. Mintii);

<https://kdpu.edu.ua/personal/ookalinichenko.html> (O. O. Kalinichenko);

<https://iitlt.gov.ua/eng/structure/departments/science/detail.php?ID=293> (S. M. Tukalo)

🆔 0000-0002-5450-6635 (S. H. Lytvynova); 0000-0003-0789-0272 (S. O. Semerikov); 0000-0001-9240-1976

(A. M. Striuk); 0000-0002-7456-3725 (M. I. Striuk); 0000-0003-2650-8921 (L. S. Kolgatina); 0000-0001-9752-0907

(V. Ye. Velychko); 0000-0003-3586-4311 (I. S. Mintii); 0000-0002-7057-2675 (O. O. Kalinichenko); 0000-0002-6268-1185

(S. M. Tukalo)



© 2021 Copyright for this paper by its authors. Use permitted under Creative Commons License Attribution 4.0 International (CC BY 4.0).

CEUR Workshop Proceedings (CEUR-WS.org)

1. Introduction

1.1. AREdu 2021 at a glance

Augmented Reality in Education (AREdu) is a peer-reviewed international Computer Science workshop focusing on research advances, applications of virtual, augmented and mixed reality in education.

AREdu topics of interest since 2018 [1, 2, 3]:

- Virtualization of learning: principles, technologies, tools
- Augmented reality gamification
- Design and implementation of augmented reality learning environments
- Augmented reality in science education
- Augmented reality in professional training and retraining



Figure 1: AREdu 2021 logo

This volume represents the proceedings of the 4th International Workshop on Augmented Reality in Education (AREdu 2021), held in Kryvyi Rih, Ukraine, on May 11, 2021. It comprises 18 contributed papers that were carefully peer-reviewed and selected from 25 submissions (<https://notso.easyscience.education/aredu/2021/>). Each submission was reviewed by at least 3, and on the average 3.1, program committee members. The accepted papers present the state-of-the-art overview of successful cases and provides guidelines for future research.

The volume is structured in five parts, each presenting the contributions for a particular workshop session.

1.2. AREdu 2021 program committee

Dr. **Olga Bondarenko**, Candidate of Pedagogical Sciences, Associate Professor, Department of Geography and Methods of Teaching, Kryvyi Rih, Kryvyi Rih State Pedagogical University Kryvyi Rih, Ukraine.

Olga Bondarenko, born in 1979, in 2001 graduated with honors from the geographical faculty of Kryvyi Rih State Pedagogical University, majoring in “Pedagogy and Methodology of Secondary Education. Geography and Biology”, acquired Bachelor Degree. In 2002 she received a Master Degree with honors in the major “Pedagogy and Methodology of Secondary Education. Geography”, qualified as a teacher of geography. In 2009, she successfully defended her PhD thesis at the Republican Higher Educational Institution “Crimean Humanities University” (Yalta) and received a PhD in Pedagogical Sciences. Since 2005 he has been working at Kryvyi Rih State Pedagogical University. Author of a number of scientific publications on vocational education,



training of future teachers for pedagogical activity. Her research interests include teacher training, the use of ICTs and GIS technologies in the educational process.

WWW: <https://kdpu.edu.ua/personal/ovbondarenko.html>

E-mail: bondarenko.olga@kdpu.edu.ua

Dr. **Roman Danel**, researcher at Department of Mechanical Engineering, Faculty of Technology, Institute of Technology and Businesses (VŠTE) in České Budějovice, Czech Republic; assistant at Department of Applied Informatics, Faculty of Economics, VŠB-Technical university of Ostrava, Czech Republic; visiting professor at WSG Bydgoszcz, Poland.

Roman Danel, born in 1967, spent 18 years in commercial practice in the field of IT / ICT, where he worked as an analyst, senior programmer, database and system administrator, project manager in information systems development, branch manager and for 4 years ran his own company specializing in SW supplies for industrial systems. He has been working at the university since 2009, in 2012-2017 he was the head of the Automation department at the Faculty of Mining and Geology, VŠB-Technical university of Ostrava. Since 2012, he has also been lecturing databases, information systems, operating system, MES system in production and www technologies at University of Economy Bydgoszcz (WSG), Poland. His research interests include information systems and automatic control in industry, databases, software engineering and business information systems.

E-mail: danel@rdanel.cz



Dr. **Irina Georgescu**, Lecturer of Computational Intelligence, Department of Informatics and Economic Cybernetics, Bucharest University of Economics, Bucharest, Romania.

Irina GEORGESCU holds a PhD in Economics from Turku Centre for Computer Science, Turku, Finland. Currently she is a lecturer at the Department of Economic Informatics and Cybernetics, Bucharest Academy of Economic Studies. Her research interests lie in the areas of fuzzy economics, computational intelligence and econometrics. She is the author of about 40 journal papers and 2 books published in Springer Verlag.

E-mail: irina.georgescu@csie.ase.ro

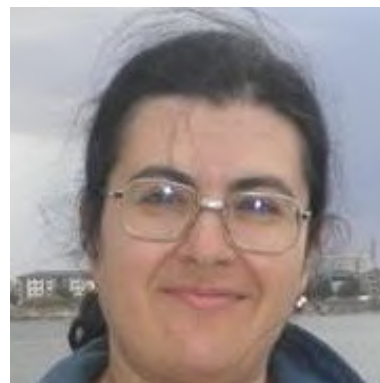

Dr. **Vita Hamaniuk**, Professor of German, Literature and Didactics, Department of German, Literature and Didactics, Kryvyi Rih State Pedagogical University, Kryvyi Rih, Ukraine.

Vita Hamaniuk, born in 1965, 1995 received a Candidate of Pedagogical Sciences degree (Dr. ped.) from the Kharkiv State Pedagogical H. Scovoroda University, in 2013 – a Doctor of Pedagogical Sciences degree (Dr. habil.) from the East-Ukrainian National Volodymyr Dahl University. In 2001 she received his habilitation as the Docent (Assoc. Prof.) at the Department of Foreign Languages of Kryvyi Rih State Pedagogical University.

In 2015 she received his habilitation as the Professor (Full Prof.) at the Department of German, Literature and Didactics of Kryvyi Rih State Pedagogical University. From September 1995 until now Vita Hamaniuk worked as a head of Department of Foreign Languages, as an Associate Professor, Head of Department, Full Professor of Department of German, Literature and Didactics. From April 2017, she works as vice-rector for research at Kryvyi Rih State Pedagogical University. Her research interests include foreign languages teaching and learning, didactics of multilingualism, e-learning, blended learning, comparative researches in Education. She has published a number of papers in Ukrainian and international journals, actively participates in international conferences and projects.

WWW: <https://kdpu.edu.ua/personal/vagamanuk.html>

E-mail: vitana65@gmail.com

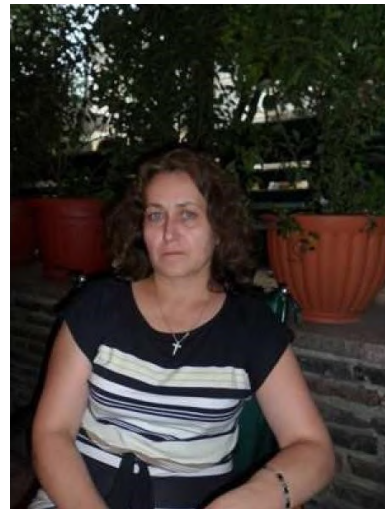

M.Sc. **Hamraz Javaheri**, German Research Center for Artificial Intelligence (DFKI)

WWW: <https://www.dfki.de/en/web/about-us/employee/person/haja01/>

E-mail: hamraz.javaheri@dfki.de



M.-Carmen Juan has a Ph.D. in Computer Science (2000) from the Universitat Politècnica de València (UPV). She has been a professor at the UPV since 1996 and a Full Professor since 2014. Her areas of interest include: computer graphics, virtual and augmented reality, advanced user interfaces and their applications to psychology, medicine, and education-entertainment.

WWW: <http://personales.upv.es/mjuanli/>, <http://www.upv.es/ficha-personal/mjuanli>

E-mail: mcarmen@dsic.upv.es



Christos Kaltsidis, ICT Teacher, PhD Candidate at Democritus University of Thrace, Greece.

He is an ICT teacher in secondary education since 2003. He has studied Computer Science at the TEI of Thessaloniki and has a master's degree in Adult Education from the Hellenic Open University. He is a PhD candidate at the Department of Molecular Biology and Genetics of the Democritus University of Thrace and his research interests include the adaption of virtual reality in education, university pedagogy, and distance education. He actively participates in actions for Safer Internet usage by students and parents and he is passionate about developing online applications.

WWW: <http://utopia.duth.gr/ckaltsid>

E-mail: ckaltsid@mbg.duth.gr



Dr. **Oleksandr Kolgatin**, Professor of Informatics, Department of Information Systems, Simon Kuznets Kharkiv National University of Economics, Kharkiv, Ukraine.

Oleksandr Kolgatin, born in 1966, received a Candidate of Technical Sciences degree (Dr. phil.) from the Institute for Low Temperature Physics and Engineering of the National Academy of Sciences of Ukraine, in 1995, the field of scientific interests was computational modeling of the heat and mass transfer processes. Since 1990, he worked in the field of teaching informatics and using information technologies in education and received a Doctor of Pedagogical Sciences degree (Dr. habil.) from the Institute of Information technologies and Learning Tools of the National Academy of Pedagogical Sciences of Ukraine, in 2011. His research interests include computational modeling, pedagogical diagnostics, information systems and technologies in education. He has published a number of papers in international journals and volumes in book series, is a member of editorial boards of Journal of Information Technologies in Education and associate editor of Information Technologies and Learning Tools.

WWW: <http://www.is.hneu.edu.ua/?q=node/294>

E-mail: kolgatin@ukr.net



Assoc. Prof. **Yaroslav Krainyk**, Head of Computer Engineering Department, Petro Mohyla Black Sea National University, Mykolaiv, Ukraine.

Yaroslav Krainyk, born in 1990, received a Ph.D. degree in Computer Systems and Components from Petro Mohyla Black Sea State University, Ukraine, in 2016. His research interests include computer systems and their applications,



embedded systems, reconfigurable computing, FPGA. Since 2016, he has been a member of Computer Engineering Department as a senior lecturer, doctoral student, and associate professor. In 2019, he became a head of Computer Engineering Department. He has participated in the reviewing of papers published by Elsevier, IEEE, and Springer. He is a section editor in Computer Science & Engineering Journal (<https://cse-journal.com/index.php/journal>).

WWW: <https://www.scopus.com/authid/detail.uri?authorId=56925498100>, <https://orcid.org/0000-0002-7924-3878>, <https://scholar.google.com/citations?user=-GCy09MAAAAJ>

E-mail: yaroslav.krainyk@chmnu.edu.ua

Dr. **Hennadiy Kravtsov**, Kherson State University, Ukraine.

WWW: <http://www.kspu.edu/About/Faculty/FPhysMathemInformatics/ChairInformatics/Staff/Kravtsov.aspx>

E-mail: kgmkherson@gmail.com

Dr. **Volodymyr Kukharenko**, Professor of Technical Cryophysics Department, National Technical University “Kharkiv Polytechnic Institute”, Kharkiv, Ukraine.

Volodymyr Kukharenko, born in 1947, received a Candidate of Technical Sciences degree from Physical Technic Institute of Low Temperature National Academy of Sciences of Ukraine. Since 1976, he has been working in the field of low temperature at the National Technical University “Kharkiv Polytechnic Institute”, where he is professor of Technical Cryophysics Department and academician of International Academy of Refrigeration UD.

His research interests include distance learning. He has published a number of papers in international journals and six books from creating distance courses, about tutor, blended learning.

WWW: <https://dl.khpi.edu.ua>

E-mail: kukharenkovn@gmail.com

Dr. **Svitlana Lytvynova**, Deputy Director for Research, Institute of Information Technologies and Learning Tools of NAES of Ukraine, Kyiv, Ukraine.

Svitlana Lytvynova, born in 1964, received a Candidate of Pedagogical Sciences degree (Dr. phil.) from the Institute of Information Technologies and Learning Tools of the National Academy of Pedagogical Sciences of Ukraine in 2011, and a Doctor of Pedagogical Sciences degree from the Institute of Information Technologies and Learning Tools of the National Academy of Sciences of Ukraine in 2016. Since



2004, he has been working on the problems on the implementation of ICT, cloud, mobile, AR & VR technologies, computer modeling in the educational process of educational institutions. She has published a number of papers in international journal and volumes in book series, is a member of editorial boards of leading Ukrainian magazines from problem ICT in education and professional development of teachers.

WWW: <https://iitlt.gov.ua/eng/>

E-mail: s.h.lytvynova@gmail.com

Ph. D. **Iryna Mintii**, associate professor of Computer Science, Department of Computer Science and Applied Mathematics, vice dean of Faculty of Physics and Mathematics, Kryvyi Rih State Pedagogical University, Kryvyi Rih, Ukraine.

Iryna Mintii received a Candidate of Pedagogical Sciences degree (Ph. D.) from the National Pedagogical Dragomanov University, Kyiv, Ukraine, in 2013. Her research interests include ICT in education. She has published a number of papers in international journals.

WWW: <https://kdpu.edu.ua/personal/ismintii.html>

E-mail: irina.mintiy@kdpu.edu.ua

Andrii Morozov, Candidate of Technical Sciences (PhD), Associate Professor, Department of Computer Science, Zhytomyr Polytechnic State University, Zhytomyr, Ukraine.

Andrii Morozov, born in 1985, received a Candidate of Technical Sciences degree (Dr. phil.). From 2006 he works at the Zhytomyr Polytechnic State University as an assistant, associate professor, head of department, dean of the faculty, vice-rector for scientific and pedagogical work. His research interests include transport logistics, discrete optimization, information and communication technologies in education. He has published a number of papers in international journals and volumes in book series, is a member of editorial boards of scientific professional edition of Ukraine "Technical Engineering".

WWW: <https://www.facebook.com/morozov.andriy>

E-mail: morozov@ztu.edu.ua

Pavlo Nechypurenko, Associate Professor of Department of Chemistry and Methods of its Teaching, Kryvyi Rih State Pedagogical University, Kryvyi Rih, Ukraine.

Pavlo Nechypurenko, born in 1981, received a Magister of Teaching of Chemistry from Kryvyi Rih State Pedagogical University, Ukraine, in 2004, and a Candidate of Pedagogical



Sciences degree (Dr. phil.) from the Luhansk Taras Shevchenko National University, Ukraine, in 2017. Since 2004, he has been working in the field of analytical chemistry and method of solving chemical problems at the Kryvyi Rih State Pedagogical University. His research interests include using of ICT on Chemistry education, Analytical Chemistry, Technique of chemical experiment. He has published a number of papers in Ukrainian and international journals and developed a series of virtual laboratory work to teaching chemistry.

E-mail: acinonyxleo@gmail.com, acinonyxleo@kdpu.edu.ua

Yulia Nosenko, Leading Researcher, Department of Cloud-Oriented Systems of Education Informatization, Institute of Information Technologies and Learning Tools of NAES of Ukraine, Kyiv, Ukraine.

Yuliia Nosenko, born in 1984, received a Candidate of Pedagogical Sciences degree (Ph.D.) in 2011. In 2010-2015 worked at Taras Shevchenko National University of Kiev (part time). Since 2010 has been working at the Institute of Information Technologies and Learning Tools of National Academy of Educational Sciences of Ukraine, where she is currently leading researcher. Her research interests relates to implementation and use of cloud services in education, formation and development of educators' digital competence, use of ICT as a tool for supporting inclusive learning. She has published over 80 scientific papers, including articles in international journals, is a member of editorial board of peer-reviewed e-journal "Information Technologies and Learning Tools".

WWW: <http://iitlt.gov.ua/structure/departments/cloud/detail.php?ID=48>

E-mail: nosenko-y@ukr.net



Vasyl Oleksiuk, PhD (pedagogical sciences), associate professor of the Department of Computer Science and Teaching Techniques, Ternopil Volodymyr Hnatiuk National Pedagogical University, Ternopil, Ukraine.

Vasyl Oleksiuk, born in 1980, received a Candidate of Pedagogical Sciences degree (Dr. phil.) from the National Pedagogical University, Kyiv, Ukraine, in 2007. Since 2003, he has been working Department of Computer Science and Teaching Techniques at Ternopil Volodymyr Hnatiuk National Pedagogical University, where he is currently associate professor. His research interests include computer networks, cloud computing, e-learning, electronic libraries. He has published a number of papers in Ukrainian and international journals, is a member of editorial boards of the journals Information Technologies and Learning Tools (Institute of Information Technologies and Learning Tools of NAES of Ukraine) and The Scientific



Issues of Ternopil Volodymyr Hnatiuk National Pedagogical University (Series: pedagogy).

WWW: <http://tnpu.edu.ua/faculty/fizmat/oleksyuk-vasil-petrovich.php>

E-mail: oleksyuk@fizmat.tnpu.edu.ua

DSc **Kateryna Osadcha**, Associate professor, Department of Computer Science and Cybernetics, Bogdan Khmelnytsky Melitopol state pedagogical university, Melitopol, Ukraine.

Kateryna Osadcha, born in 1977, received a Candidate of Pedagogical Sciences (PhD in Education) from the Vinnytsia State Pedagogical University named after Mykhailo Kotsiubynsky, Ukraine, in 2010 and received a Doctor of Pedagogical Sciences (PhD in Education) from the Classic Private University (Zaporizhzhia), Ukraine, in 2020. Since 2011, she has been working as an Associate professor of the Department of Computer Science and Cybernetics at the Bogdan Khmelnytsky Melitopol state pedagogical university. Her research interests include: computer science, network technology, programming, ICT, e-learning, engineering education, educational technology, tutoring. She is author of about a hundred scientific works, including textbooks, monographs, author's certificates. She is a member of editorial boards of "Ukrainian Journal of Educational Studies and Information Technology" (Ukraine), "International Conference on Higher Education Advances" (Spain), "Transactions of Kremenchuk Mykhailo Ostrohradskyi National University" (Ukraine), "Professional Education: Methodology, Theory and Technologies" (Ukraine), "Computing Conference 2021" (United Kingdom).

WWW: <http://osadcha.mdpu.org.ua>

E-mail: okp@mdpu.org.ua



Dr. **Viacheslav Osadchyi**, Professor of Department of Computer Science and Cybernetics, Bogdan Khmelnytsky Melitopol state pedagogical university, Melitopol, Ukraine.

Viacheslav Osadchyi, born in 1975, received a Candidate of Pedagogical Sciences (PhD in Education) from the Vinnytsia State Pedagogical University named after Mykhailo Kotsiubynsky, Ukraine, in 2006, and a Doctor of Pedagogical Sciences from the Vinnytsia State Pedagogical University named after Mykhailo Kotsiubynsky, Ukraine, in 2013. Since 1999, he has been working in the field of information technology and vocational education at the Bogdan Khmelnytsky Melitopol state pedagogical university. Now – Head of the Department of Computer Science. His research interests include: computer science, information networks, ICT, programming, software development, information systems, data science. He has published a number of papers in international journals. He is a



member of editorial boards of “Ukrainian Journal of Educational Studies and Information Technology” (Ukraine), “Computing Conference” (formerly called “Science and Information (SAI) Conference”) (UK), Intelligent Systems Conference (IntelliSys) (The Netherlands), “International Conference on Higher Education Advances” (Spain), “Transactions of Kremenchuk Mykhailo Ostrohradskyi National University” (Ukraine), “Information Technologies and Learning Tools” (Ukraine), “Scientific papers of Berdyansk State Pedagogical University Series: Pedagogical sciences” (Ukraine).

WWW: <http://osadchyi.mdpu.org.ua>

E-mail: poliform55@gmail.com

Dr. **Liubov Panchenko**, Professor at the Department of Sociology, National Technical University of Ukraine “Igor Sikorsky Kyiv Polytechnic Institute”, Kyiv, Ukraine

Liubov Panchenko was awarded a Candidate of Pedagogical Sciences degree (Dr. phil.) from H. S. Skovoroda Kharkiv National Pedagogical University, Kharkiv, Ukraine, in 1995, and a Doctor of Pedagogical Sciences degree (Dr. habil.) from the Luhansk Taras Shevchenko National University, in 2012. Since 1993, she has been working in the field of information and communication technology in education. Since 2016 she has been a Professor at the Department of Sociology, National Technical University of Ukraine “Igor Sikorsky Kyiv Polytechnic Institute”. Her research interests include information and communication technology in education, university’s educational environment, MOOCs, data analysis and multivariate methods in scientific research, digital storytelling, adult education. She has published a number of papers and text books (“Computer data analysis”, “Data analysis practicum”, “Mathematical and statistical methods of sociological information’s analysis”) and is an editorial board member of the Ukrainian journals “Information Technologies and Learning Tools” (associated editor), “e-Environment of Modern University”, and “Humanization of the educational process”.

WWW: <http://www.sociology.kpi.ua/en/faculty-2>

E-mail: lubov.felixovna@gmail.com

Olga Pinchuk, Deputy Director for Scientific Experimental Work, Leading Researcher, PhD (in Pedagogics), Senior Researcher in the field of information and communication technologies in education. Education: M.P. Drahomanov Kyiv State Pedagogical Institute in specialties of Mathematics, Computer Science and Computer Engineering teacher. Currently the experience in teaching is 25 years. Since 2005 she work in the Institute of Information Technologies and Learning Tools of the NAES of Ukraine.

She worked on the implementation of the tasks of the



scientific research works “Scientific and methodological foundations use of computer oriented tools in teaching natural and mathematical subjects in profile School”, “Scientific and methodological principles of organization of distance learning environment in secondary schools” , “Methodology of design network resource centers of distance education of secondary schools”. “Formation of information and educational environment for learning high school students through technology electronic social networks” (Head of Scientific Research), “System of computer modeling of cognitive tasks for the formation of competencies of students in natural and mathematical subjects”. She have more than 80 published scientific works, the author of collective monographs, manuals. She also obtain the post of co-editors-in-chief of “Information Technologies and Learning Tools “, a peer-reviewed e-journal in educational sphere, publishing full-text articles online with immediate open-access.

WWW: <http://iitlt.gov.ua/>

E-mail: opinchkuk@iitlt.gov.ua

Dr. **Serhiy Semerikov**, Professor of Computer Science and Educational technology, Kryvyi Rih State Pedagogical University, Ukraine.

Serhiy Semerikov is professor of Department of Computer Science and Applied Mathematics at Kryvyi Rih State Pedagogical University. He got both PhD and DSc in education (informatics) from the National Pedagogical Dragomanov University in 2001 and 2009, respectively. The main directions of Dr. Semerikov’ research is methods of learning and educational technology.

WWW: <https://kdpu.edu.ua/semerikov/>

E-mail: semerikov@gmail.com



Dr. **Yevhenii Shapovalov**, Chief specialist in Ministry of Digital Transformation of Ukraine and Researcher in National Center “Junior Academy of Science of Ukraine”.

Yevhenii Shapovalov was born in 1992, received Ph.D. in 2020 from the National University of Life and Environmental Sciences of Ukraine in biotechnology. He worked in the field of digitalization of chemistry education in the National Center “Junior Academy of Science of Ukraine” from 2014 to 2020 and then start to work in the Ministry of Digital transformation. He has studied the anaerobic digestion of high nitrogen content in biotechnology and modern approaches in the digitalization of education, such as using AR, smart tools, and ontologies to structure education content. He is a board member of NGO “European Studies’ Platform for Sustainable Development” and has experience in international educational projects (Erasmus+).

WWW: <http://www.nas.gov.ua/UA/PersonalSite/Pages/default.aspx?PersonID=0000026333>



E-mail: sjb@man.gov.ua, shapovalov@thedigital.gov.ua

Dr. **Andrii Striuk**, Ph.D., Head of Simulation and Software Engineering department of Kryvyi Rih National University, Kryvyi Rih, Ukraine.

Andrii Striuk, born in 1979. In 2000 he graduated from the Kryvyi Rih Technical University with a degree in Automated Systems Software. In 2001, he received a master's degree in computer science. Has been working at the Department of Modeling and Software of Kryvyi Rih National University since 2000. Combines educational activities with practical, developing and implementing educational software products. In 2011 he defended his Ph.D. thesis. From 2014 to 2017 he is studying at the doctoral program in Institute of Information Technologies and Learning Tools of the NAES of Ukraine (Kyiv, Ukraine). In 2017, he was awarded the Prize of the President of Ukraine for young scientists. Heads the Simulation and Software Engineering department of Kryvyi Rih National University since 2018. Field of scientific interest: professional training of software engineers, mobile learning technologies, the use of augmented reality technologies in education.

WWW: <http://mpz.knu.edu.ua/pro-kafedru/vikladachi/224-andrii-striuk>

E-mail: andrii.striuk@knu.edu.ua



Dr. **Tetiana Vakaliuk**, professor, professor of the department of Software Engineering, Zhytomyr Polytechnic State University, Zhytomyr, Ukraine.

Tetiana Vakaliuk, born in 1983, received a Candidate of Pedagogical Sciences degree from the National Pedagogical Dragomanov University, Ukraine, in 2013, and a Doctor of Pedagogical Sciences degree from the Institute of Information Technologies and Learning Tools of the National Academy of Sciences of Ukraine, in 2019. Since 2019, she has been working in the field of information technologies at the Zhytomyr Polytechnic State University. Her research interests include information technologies, ICT in Education, Cloud technologies. She has published a number of papers in international journals, is a member of editorial boards of Information Technologies and Learning Tools, Zhytomyr Ivan Franko State University Journal: Pedagogical Sciences, Collection of Scientific Papers of Uman State Pedagogical University.

WWW: <https://sites.google.com/view/neota>

E-mail: tetianavakaliuk@gmail.com



Dr. **Nataliia Valko**, PhD of Physics and Mathematic Sciences, DSc of Educational Sciences, Department of Informatics, Software Engineering and Economic Cybernetics, Kherson State University, Kherson, Ukraine.

Nataliia Valko, in 2006 earned a PhD degree of Physics and Mathematic Sciences in specialty “Mathematical modeling and numerical methods”. She has extensive experience in teachers education via modern teaching technologies, blended learning, STEM-education. Her teaching experience in University is over 20 years. She is one of the organizers of the STEM school of KSU. She has management skills in the field of teacher training, planning educational activities, creating distance learning courses on the Moodle platform. She manages students design work to create models of robotic systems. Effectively applies innovative teaching methods for future teachers of natural-mathematical disciplines using robotics and their preparation for using STEM-technologies in teaching. She actively studies innovative teaching methods, methods of project activity. She has published a number of papers of different kinds (including books, articles in scientific international journals, conference proceedings etc.), is a member of editorial boards of Journal of Information Technologies in Education (ITE).



WWW: <http://www.kspu.edu/About/Faculty/FPhysMathemInformatics/ChairInformatics/Staff/NValko.aspx>

E-mail: valko@ksu.ks.ua

Nataliia Veretennikova, PhD, candidate of social communication, assistant of the Department of Information Systems and Networks, Lviv Polytechnic National University, Lviv, Ukraine.

Nataliia Veretennikova, born in 1990, received PhD degree from Vernadsky National Library of Ukraine in 2017. She is a winner of the President’s Award for Young Scientists in 2019 and a winner of the Regional Prize for Young Scientists and Researchers for Scientific Achievements that Contribute to Social and Economic Transformation in the Region and Affirm the High Authority of Lviv Region Scholars in Ukraine and in the World. Her scientific research relates to the field of electronic science, linguistic support, and social communications. She is an author of a lot of papers in domestic and international journals as well as volumes. She is a member of editorial boards and joins in Programme and Organizing committees of international conferences or workshops.



WWW: http://wiki.lp.edu.ua/wiki/%D0%92%D0%B5%D1%80%D0%B5%D1%82%D0%B5%D0%BD%D0%BD%D1%96%D0%BA%D0%BE%D0%B2%D0%B0_%D0%9D%D0%B0%D1%82%D0%B0%D0%BB%D1%96%D1%8F_%D0%92%D1%8F%D1%87%D0%B5%D1%81%D0%BB%D0%B0%D0%B2%D1%96%D0%B2%D0%BD%D0%B0

E-mail: nataver19@gmail.com

Dr. **Kateryna Vlasenko**, Professor of Maths, Department of Mathematics, National University of “Kyiv Mohyla Academy”, Kyiv, Ukraine.

Kateryna Vlasenko, born in 1966, received a Candidate of Pedagogical Sciences degree (PhD) from the National Pedagogical Dragomanov University, Ukraine, in 2004, and a Doctor of Pedagogical Sciences degree (D.Sc. in Educational Science) from the Bohdan Khmelnytsky National University of Cherkasy, in 2011. Since 2008, she has been working in the field of mathematical and pedagogical modeling at Donbas State Engineering Academy. Her research interests include the issues of mathematics education. She has published a number of papers in international journals and volumes in book series, is a member of editorial boards of Innovative Solutions in Modern Science, Topical Issues of Natural and Mathematical Education Sumy State Pedagogical University named after A. Makarenko.

WWW: <http://formathematics.com/tutors/kateryna-vlasenko/>

E-mail: vlasenkov@ukr.net



Dr. **Yuliia Yechkalo**, Associate professor, Department of Physics, Kryvyi Rih National University, Kryvyi Rih, Ukraine.

Yuliia Yechkalo, born in 1981, received a Candidate of Pedagogical Sciences degree from the Kirovograd State Vladimira Vinnichenka Pedagogical University, Ukraine, in 2013. Since 2005, she has been working at the National Metallurgical Academy of Ukraine. She has been working at the Kryvyi Rih National University since 2012. Her research interests include theory and methods of education (physics) and information and communication technologies in education.

E-mail: uliaechk@gmail.com



2. Articles overview

2.1. Session 1: Virtualization of learning: principles, technologies, tools

Iryna S. Mintii (figure 2), Tetiana A. Vakaliuk, Svitlana M. Ivanova, Oksana A. Chernysh, Svitlana M. Hryshchenko and Serhiy O. Semerikov in the article “Current state and prospects of distance learning development in Ukraine” [4] presents a thorough literature review and highlights the

main stages in the development of distance learning in Ukraine. Moreover, the paper suggests the periodization of distance learning. Research data on distance learning peculiarities in Ukraine during and before the pandemic make it possible to outline the main problems faced by higher education institutions' (HEIs) teachers and students. Therefore, the study emphasizes common problems, namely hardware/software issues, poor Internet connectivity, lack of students' self-discipline and self-organization, absence of live communication, insufficient digital literacy skills etc. The paper analyzes the benefits of MOOCs that aim at digital competence development. It presents the results of students' survey on qualitative changes in distance learning organization in 2020–2021 academic year compared to 2019–2020 academic year. The results prove that in current academic year, distance learning is better organized due to a sufficient structure of distance learning courses, the use of one platform for the whole educational institution, higher teachers' digital competence, the use of various resources etc.

This article highlights further research by the authors, begun in [5, 6, 7, 8, 9, 10, 11, 12, 13, 14, 15, 16, 17, 18, 19, 20, 21, 22, 23, 24, 25, 26, 27, 28, 29, 30, 31, 32, 33, 34, 35, 36, 37, 38].



Figure 2: Presentation of paper [4].

The technologies of the augmented and virtual reality have a special role in medical education as an additional tool for training professional skills in pre-clinical practice. In the paper “The virtual reality simulator development for dental students training: a pilot study” [39], Yulia Yu. Dyulichева, Daniil A. Gaponov (figure 3), Raša Mladenović and Yekaterina A. Kosova describe the development of a virtual reality simulator with immersion in VR scene for dentist office and simulation of tooth drilling. Such kinds of simulators would contribute to evolving capacities of motor skills and hand-eye coordination. The VR simulator for dental students training is developed for Oculus Quest 2 VR headset with six degrees of freedom. The Marching Cubes algorithm is chosen as an optimal decision for autonomous VR headsets, the computational power of which is much lower than PCs. The main stages of the development of tooth drilling simulation are considered. They include voxelization, marching cubes algorithm, collision detection, and detection of penetration depth of the dental drill. The experience of VR scene using

for dental students training has been piloted at the Faculty of Dentistry at the V. I. Vernadsky Crimean Federal University. To evaluate the pilot study we used a satisfaction questionnaire, which evaluated the realism of tooth 3D model drilling and the realism of VR scene for the creation of a dentist's office atmosphere.

This article highlights further research by the authors, begun in [40].

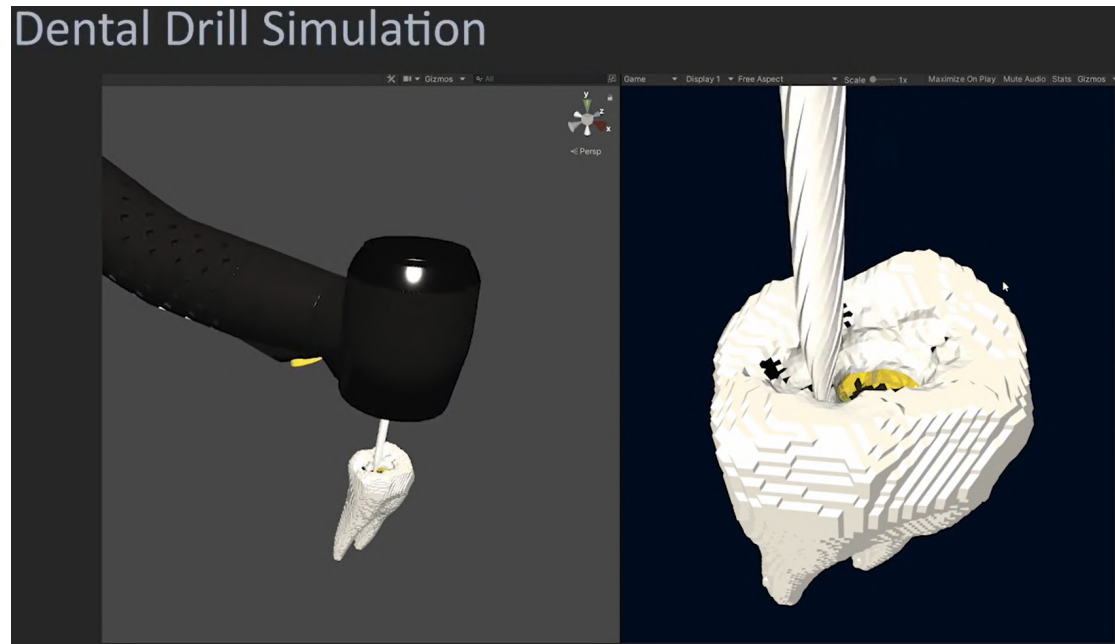

Figure 3: Presentation of paper [39].

Progress of modern digital technologies enlarged the quantity of researches about implementation and usage of VR technologies in education process of higher educational establishments. The article “Application of VR technologies in building future maritime specialists’ professional competences” [41] by Serhii A. Voloshynov, Felix M. Zhuravlev, Ivan M. Riabukha, Vitaliy V. Smolets and Halyna V. Popova (figure 4) provides analysis of best practices of simulation technologies application in maritime education. Absence of national research experience, evidence base for efficiency of new VR simulators operation leaves this issue open to be investigated in terms of researches on their performance effectiveness. The article proposes overview of advantages of VR technologies implementation aimed at building and shaping of future maritime specialists’ professional competences. Authors investigate potential application possibilities of interactive and representative potential of immersion digital technologies during education process at maritime educational establishments. Problem of VR technologies integration into education and training of future seafarers is highlighted, as well as possibility to use virtual courses in the process of future maritime specialists’ training. The article reveals prognostic validity of VR simulators used for building of professional competences.

This article highlights further research by the authors, begun in [42, 43, 44].



Figure 4: Presentation of paper [41].

The article ‘Selection of online tools for creating math tests’ [37] by Oksana V. Zaika, Tetiana A. Vakaliuk (figure 5), Andrii V. Riabko, Roman P. Kukharchuk, Iryna S. Mintii and Serhiy O. Semerikov considers online tools for creating tests, which should be used when teaching mathematics in both higher education and general secondary education. Among the variety of online means of creating tests by the method of expert evaluation, three were identified, which allow conducting various tests both in the classroom and remotely, which are free and do not require special conditions for their use and which work on smartphones. The advantages and disadvantages of three online tools for creating tests Kahoot!, Quizizz, Classtime are analyzed, and a comparative description of the selected tools is given. Criteria for the selection of such tools were identified – functional-didactic and organizational. The following indicators belong to the functional-didactic: the presence of different types of questions, including open-ended; use of formulas, both in questions and in answers; use of pictures, both in questions and in answers; no restrictions on the length of questions and answers; instant receipt of results by the teacher, their evaluation and analysis; instant receipt of results by the respondent; to the organizational: the availability of a free version; no need to install the program; ease of use – characterizes the convenience and clarity of the interface for creating tests and their use; possibility of testing in online and offline mode; time limits, both for a single question and the whole test; random order of questions/answer options; instant demonstration of the correct answer to the respondent. With the help of expert evaluation, it was found that according to these criteria, Quizizz is the most appropriate for testing.

This article highlights further research by the authors, begun in [45].

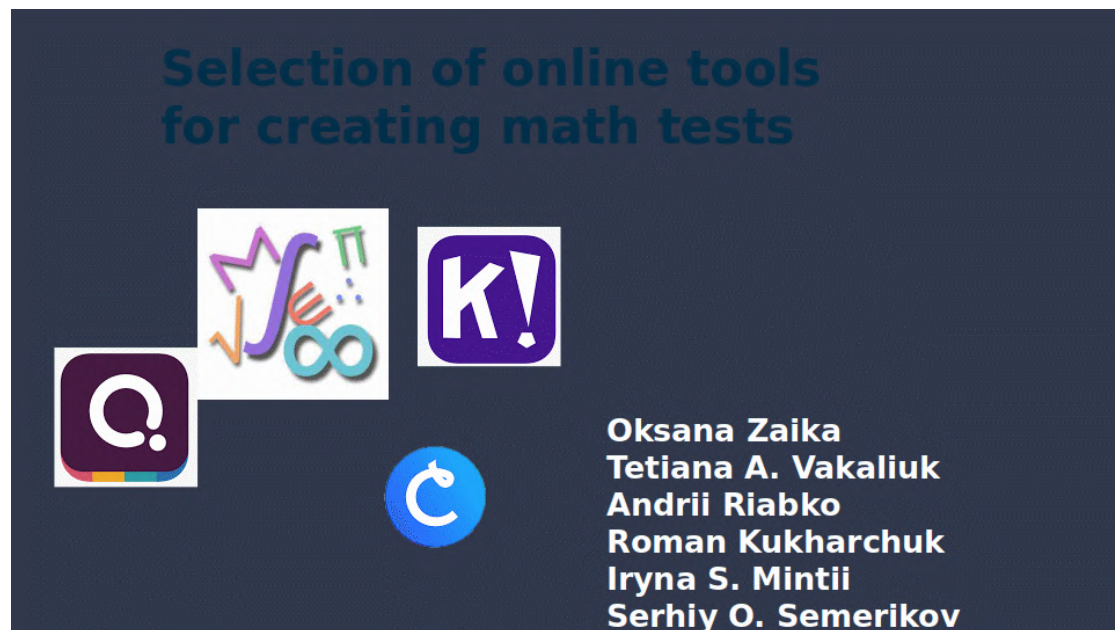

Figure 5: Presentation of paper [37].

2.2. Session 2: Augmented reality gamification

Use of visual methods plays a significant role in learning. ICT allow us to create electronic educational resources in a new format and with new opportunities. The study of their didactic possibilities, forms and methods of their application is a topical issue. Simulation, virtualization, gamification requires new knowledge about their application, and therefore, the problem of training future teachers to use them is an urgent and important part of training. In the article “Gamification when studying logical operators on the Minecraft EDU platform” [46] by Elena G. Fedorenko, Nataliia V. Kaidan, Vladyslav Ye. Velychko (figure 6) and Vladimir N. Soloviev the modern achievements in the use of serious games in education were investigated and analyzed, the possibilities of using virtual worlds in education were considered, the recommendations for the practical training of future teachers to use them were developed. In practice, the effectiveness of the use of virtual tools in education has been tested. A pedagogical experiment has been launched to identify the effectiveness of gamification in the realities of education in Ukraine.

This article highlights further research by the authors, begun in [47, 48, 49, 50, 51, 52, 53].

2.3. Session 3: Design and implementation of augmented reality learning environments

The article “Analysis of tools for the development of augmented reality technologies” [54] by Tetiana A. Vakaliuk (figure 7) and Svitlana I. Pochtoviuk considers cross-platform products that should be used to develop augmented reality technologies: Unreal Development, Kit, Unity, Godot, Engine, Cocos2D, MonoGame, Unreal Engine, Marmalade, and others. Also, the

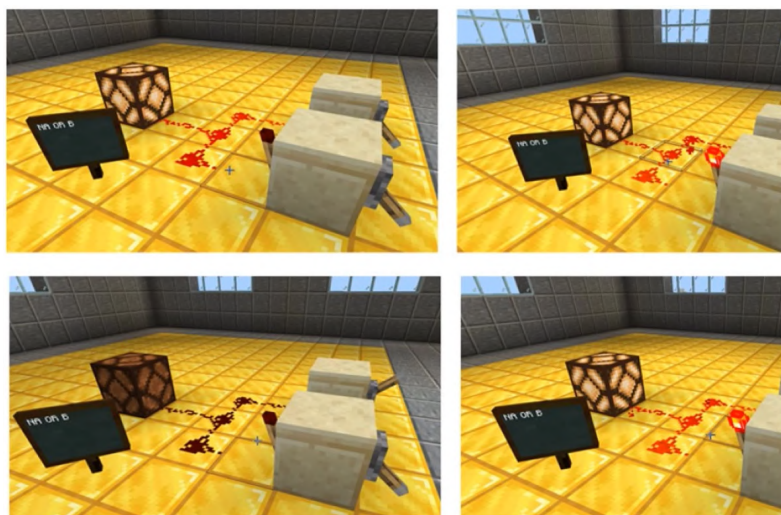

Minecraft EDU: Logical Operators

Figure 6: Presentation of paper [46].

possibilities of known SDKs for the development of augmented reality applications (Wikitude, Vuforia, Kudan, Maxst, Xzing, NyARToolkit, Metaio SDK) are given. It is established that for the development of augmented reality technologies can be used not only cross-platform engines but also sets of development tools. Such kits allow you to speed up and simplify the process of developing any program with elements of augmented reality. These advantages and disadvantages will help beginners to choose the most convenient tool for developing augmented reality technologies. In addition, the article attempts to identify criteria and indicators for the selection of such environments, as well as their expert evaluation.

This article highlights further research by the authors, begun in [55, 56, 57, 58, 59].

In the paper “Using augmented reality for architecture artifacts visualizations” [60] Zarema S. Seidametova, Zinnur S. Abduramanov and Girey S. Seydametov (figure 8) compared the main SDKs for the development of a marker-based AR apps and 3D modeling freeware computer programs used for developing 3D-objects. We presented a concept, design and development of AR application “Art-Heritage” with historical monuments and buildings of Crimean Tatars architecture (XIII-XX centuries). It uses a smartphone or tablet to alter the existing picture, via an app. Using “Art-Heritage” users stand in front of an area where the monuments used to be and hold up mobile device in order to see an altered version of reality.

The article “Augmented reality while studying radiochemistry for the upcoming chemistry teachers” [61] by Liliia Ya. Midak (figure 9), Ivan V. Kravets, Olga V. Kuzyshyn, Tetiana V. Kostiuk, Khrystyna V. Buzhdyhan, Victor M. Lutsyshyn, Ivanna O. Hladkoskok, Arnold E. Kiv and Mariya P. Shyshkina is describe the mobile application (on Android) designed to visualize the basic definitions of the discipline “Radiochemistry and radioecology” in 3D. Studying the education material of this discipline (phenomena of radionuclide, radioisotope, the nucleus, the fundamental particle etc and their specifics) requires a more sophisticated explanation from the teacher and dynamic dimensional image from the student. Decent detailed visualization



Maxst



Figure 4: Xzimg



Figure 5: NyARToolkit



Figure 7: Presentation of paper [54].

of the study material makes this process easier. So applying the augmented reality is rational for the purpose of visualizing the study material, applying it allows demonstrate 3D-models of the nucleus, the fundamental particles, the nature of radioactive decay, nuclear fission, the specifics of managing the nuclear weapon and the NPS. Involving this instrument of the up-to-date information and communication technologies while studying the new material gives the opportunity to develop and boost the spatial imagination of the students, “to see” the invisible and to understand the received material in a better way, which improves its better memorizing. As far as the augmented reality is one of the most recent new-age education trends, all the teachers are required to have the ability to use it. In this reason the upcoming teachers, the students of the “General Education (Chemistry)” specialty, must be trained with this technology. Within the study process the students have the opportunity to review the positive moments of applying AR from a student’s stand of point and to understand, how to apply similar education tools in the future pedagogic work.

This article highlights further research by the authors, begun in [62, 63, 64, 65, 66, 67, 68, 69, 70, 71].

2.4. Session 4: Augmented reality in science education

The article “Review of the course “Development of Virtual and Augmented Reality Software” for STEM teachers: implementation results and improvement potentials” [72] by Serhiy O. Semerikov, Mykhailo M. Mintii (figure 10) and Iryna S. Mintii provides a review of applying the

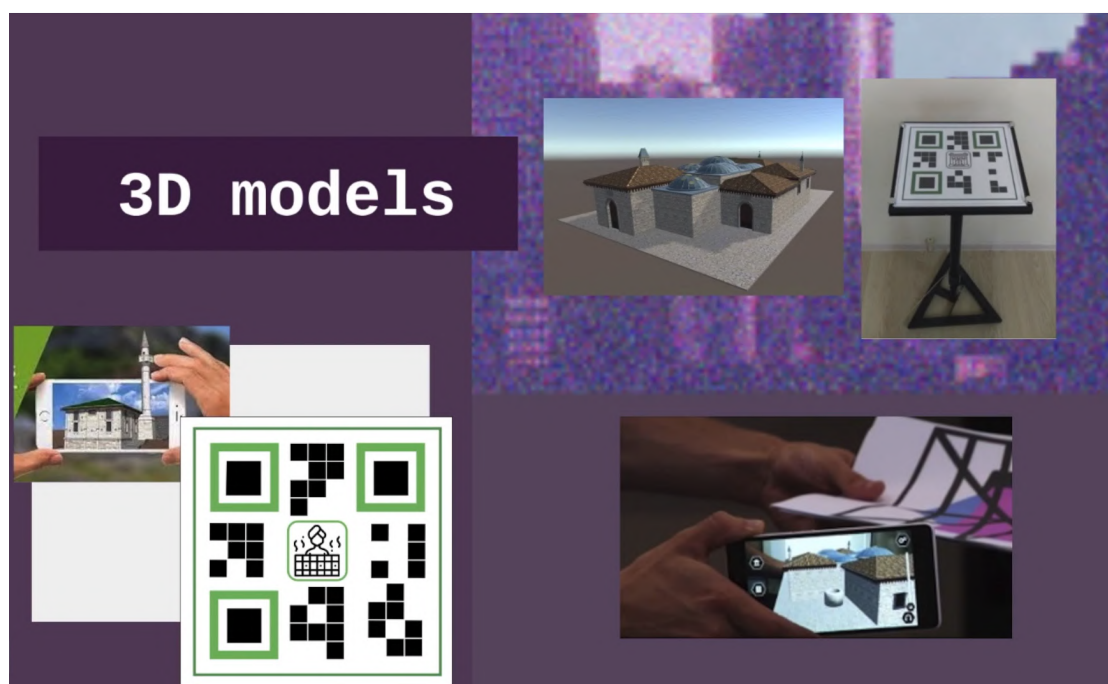

Figure 8: Presentation of paper [60].

virtual and augmented reality technology to education. There are analysed VR and AR tools applied to the course “Development of VR and AR software” for STEM teachers and specified efficiency of mutual application of the environment Unity to visual design, the programming environment (e.g. Visual Studio) and the VR and AR platforms (e.g. Vuforia). JavaScript language and the A-Frame, AR.js, Three.js, ARToolKit and 8th Wall libraries are selected as programming tools. The designed course includes the following modules: development of VR tools (VR and Game Engines; physical interactions and camera; 3D interface and positioning; 3D user interaction; VR navigation and introduction) and development of AR tools (set up AR tools in Unity 3D; development of a project for a photograph; development of training materials with Vuforia; development for promising devices). The course lasts 16 weeks and contains the task content and patterns of performance. It is ascertained that the course enhances development of competences of designing and using innovative learning tools. There are provided the survey of the course participants concerning their expectations and the course results. Reduced amounts of independent work, increased classroom hours, detailed methodological recommendations and increased number of practical problems associated with STEM subjects are mentioned as the course potentials to be implemented.

This article highlights further research by the authors, begun in [73, 74, 66, 58, 38, 75].

High-quality professional training of a future mathematics teacher who is able to meet the challenges that permeate all sides, the realities of the globalizing information society, pre-

Augmented Reality

- can help to focus on certain elements of the image from the camera;
- increases understanding of the objects around by means of supplying the appropriate information that is laid on the image with a text message or a visual image.



8

Figure 9: Presentation of paper [61].

supposes reliance on a highly effective learning environment. The purpose of the research “Improving the learning environment for future mathematics teachers with the use application of the dynamic mathematics system GeoGebra AR” [76] by Nataliia V. Osypova (figure 11) and Volodimir I. Tatochenko is to transform the traditional educational environment for training future mathematics teachers with the use of the GeoGebra AR dynamic mathematics system, the introduction of cloud technologies into the educational process. The educational potential of GeoGebra AR in the system of professional training of future mathematics teachers is analyzed in the paper. Effective and practical tools for teaching mathematics based on GeoGebra AR using interactive models and videos for mixed and distance learning of students are provided. The advantages of the GeoGebra AR dynamic mathematics system are highlighted. The use of new technologies for the creation of didactic innovative resources that improve the process of teaching and learning mathematics is presented on the example of an educational and methodological task, the purpose of which is to create didactic material on the topic “Sections of polyhedra”. While solving it, future teachers of mathematics should develop the following constituent elements: video materials; test tasks for self-control; dynamic models of sections of polyhedra; video instructions for constructing sections of polyhedra and for solving basic problems in the GeoGebra AR system. The article highlights the main characteristics of the

Homework example (6th week)

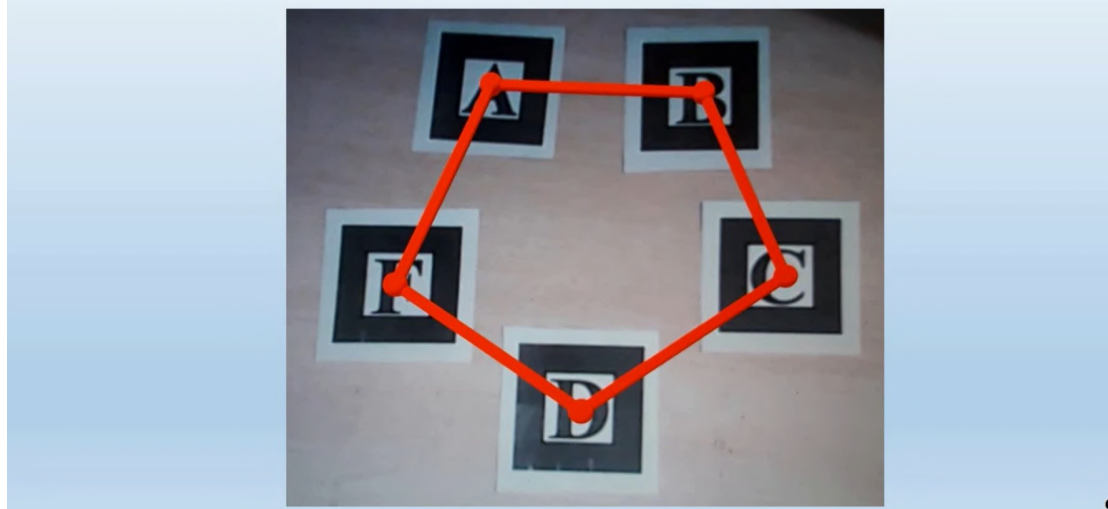

Figure 10: Presentation of paper [72].

proposed educational environment for training future mathematics teachers using the GeoGebra AR dynamic mathematics system: interdisciplinarity, polyprofessionalism, dynamism, multicomponent.

This article highlights further research by the authors, begun in [77, 78].

The article “The development and use of mobile app AR Physics in physics teaching at the university” [79] by Arnold E. Kiv, Vladyslav V. Bilous, Dmytro M. Bodnenko, Dmytro V. Horbatovskyi, Oksana S. Lytvyn and Volodymyr V. Proshkin (figure 12) outlines the importance of using Augmented Reality in physics education at the university as a valuable tool for visualization and increasing the attention and motivation of students to study, solving educational problems related to future professional activities, improving the interaction of teachers and students. Provided an analysis of the types of AR technology and software for developing AR apps. The sequences of actions for developing the mobile application AR Physics in the study of topics: “Direct electronic current”, “Fundamentals of the theory of electronic circuits”. The software tools for mobile application development (Android Studio, SDK, NDK, Google Sceneform, 3Ds MAX, Core Animation, Asset Media Recorder, Ashampoo Music Studio, Google Translate Plugin) are described. The bank of 3D models of elements of electrical circuits (sources of current, consumers, measuring devices, conductors) is created. Because of the students’ and teachers’ surveys, the advantages and disadvantages of using AR in the teaching process are discussed. Mann-Whitney U-test proved the effectiveness of the use of AR for laboratory works in physics by students majoring in “Mathematics”, “Computer Science”, and “Cybersecurity”.

This article highlights further research by the authors, begun in [80, 81, 82, 83, 84, 85, 86?].

The article ‘Using Blippar to create augmented reality in chemistry education’ [87] by Yuliya



Figure 11: Presentation of paper [76].

V. Kharchenko, Olena M. Babenko and Arnold E. Kiv (figure 13) presents an analysis of the possibilities and advantages of augmented reality technologies and their implementation in training of future Chemistry and Biology teachers. The study revealed that the use of augmented reality technologies in education creates a number of advantages, such as: visualization of educational material; interesting and attractive learning process; increasing student motivation to study and others. Several augmented reality applications were analyzed. The Blippar app has been determined to have great benefits: it's free; the interface is simple and user-friendly; the possibility of using different file types; the possibility of combining a large amount of information and logically structuring it; loading different types of information: video, images, 3D models, links to sites, etc. Thus, convenient interactive projects were developed using the Blippar application, which were called study guide with AR elements, and implemented in teaching chemical disciplines such as Laboratory Chemical Practice and Organic Chemistry. Using such study guide with AR elements during classes in a real chemical laboratory is safe and does not require expensive glassware. The student interviews revealed that the use of the Blippar application facilitated new material understanding, saved time needed to learn material, and was an effective addition to real-life learning.

2.5. Session 5: Augmented reality in professional training and retraining

Training and professional development of nuclear power plant personnel are essential components of the atomic energy industry's successful performance. The rapid growth of virtual reality (VR) and augmented reality (AR) technologies allowed to expand their scope and caused



Steps

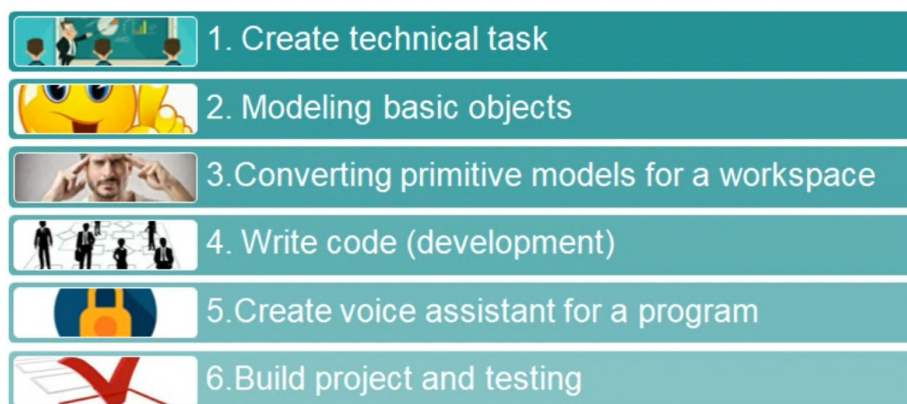
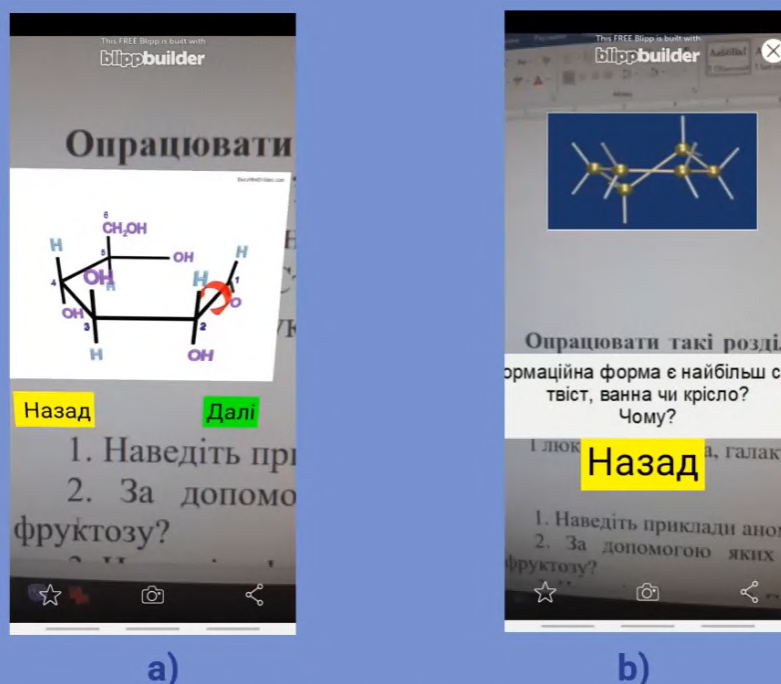

Figure 12: Presentation of paper [79].

the need for various studies and experiments in terms of their application and effectiveness. Therefore, the article “Immersive technology for training and professional development of nuclear power plants personnel” [88] by Oleksandr O. Popov, Anna V. Iatsyshyn (figure 14), Andrii V. Iatsyshyn, Valeriia O. Kovach, Volodymyr O. Artemchuk, Viktor O. Gurieiev, Yulii G. Kutsan, Iryna S. Zinovieva, Olena V. Aliexsieieva, Valentyna V. Kovalenko and Arnold E. Kiv studies the peculiarities of the application of VR and AR technologies for the training and professional development of personnel of nuclear power plants. The research and experiments on various aspects of VR and AR applications for specialists’ training in multiple fields have recently started. The analysis of international experience regarding the technologies application has shown that powerful companies and large companies have long used VR and AR in the industries they function. The paper analyzes the examples and trends of the application of VR technologies for nuclear power plants. It is determined that VR and AR’s economic efficiency for atomic power plants is achieved by eliminating design errors before starting the construction phase; reducing the cost and time expenditures for staff travel and staff training; increasing industrial safety, and increasing management efficiency. VR and AR technologies for nuclear power plants are successfully used in the following areas: modeling various atomic energy processes; construction of nuclear power plants; staff training and development; operation, repair, and maintenance of nuclear power plant equipment; presentation of activities and equipment. Peculiarities of application of VR and AR technologies for training of future specialists and advanced training of nuclear power plant personnel are analyzed. Staff training and professional development using VR and AR technologies take place in close to real-world conditions that are safe for participants and equipment. Applying VR and AR at nuclear power plants can increase efficiency: to work out the order of actions in the emergency mode; to optimize the temporary cost of urgent repairs; to test of dismantling/installation of elements of the equipment; to

The use of Blippar in Organic Chemistry



Displaying a blipp (study guide with AR elements) on the screen: a) video, b) task.

Figure 13: Presentation of paper [87].

identify weaknesses in the work of individual pieces of equipment and the working complex as a whole. The trends in the application of VR and AR technologies for the popularization of professions in nuclear energy among children and youth are outlined. Due to VR and AR technologies, the issues of “nuclear energy safety” have gained new importance both for the personnel of nuclear power plants and for the training of future specialists in the energy sector. Using VR and AR to acquaint children and young people with atomic energy in a playful way, it becomes possible to inform about the peculiarities of the nuclear industry’s functioning and increase industry professions’ prestige.

This article highlights further research by the authors, begun in [89, 63].

The article “Using augmented reality in university education for future IT specialists: educational process and student research work” [90] by Vladyslav V. Babkin, Viktor V. Sharavara, Volodymyr V. Sharavara, Vladyslav V. Bilous (figure 15), Andrei V. Voznyak and Serhiy Ya. Kharchenko substantiates the feature of using augmented reality (AR) in university training of future IT specialists in the learning process and in the research work of students. The survey of

Features of immersive technology application to teach future specialists and for NPPs personnel advance training programs

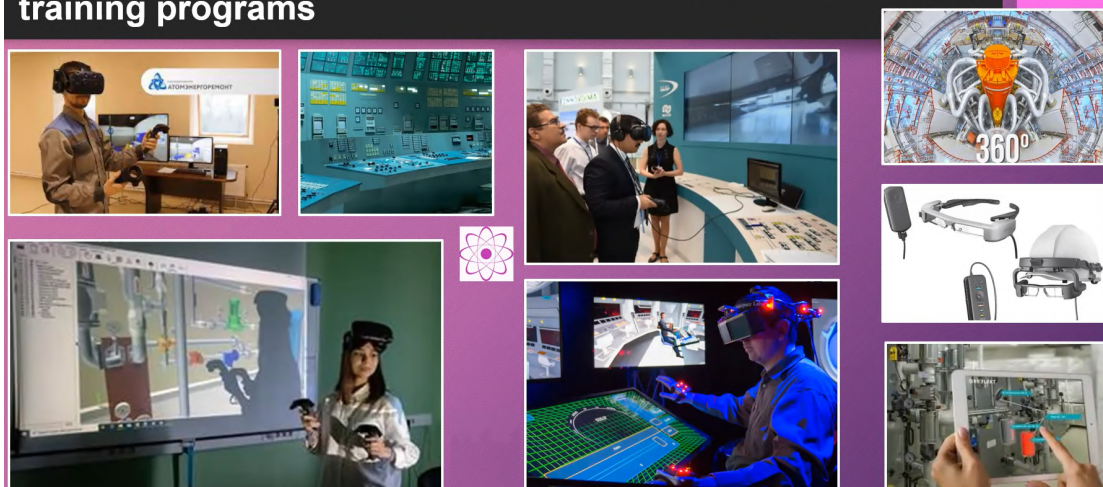

Figure 14: Presentation of paper [88].

university teachers analyzed the most popular AR applications for training future IT specialists (AR Ruler, AR Physics, Nicola Tesla, Arloon Geometry, AR Geometry, GeoGebra 3D Graphing Calculator, etc.), disclose the main advantages of the applications. The methodological basis for the implementation of future IT specialists research activities towards the development and use of AR applications is substantiated. The content of the activities of the student's scientific club "Informatics studios" of Borys Grinchenko Kyiv University is developed. Students as part of the scientific club activity updated the mobile application, and the model bank corresponding to the topics: "Polyhedrons" for 11th grade, as well as "Functions, their properties and graphs" for 10th grade. The expediency of using software tools to develop a mobile application (Android Studio, SDK, NDK, QR Generator, FTDS Dev, Google Sceneform, Poly) is substantiated. The content of the stages of development of a mobile application is presented. As a result of a survey of students and pupils the positive impact of AR on the learning process is established.

In modern conditions, innovative augmented reality technologies are actively developing, which are widespread in many areas of human activity. Introduction of advanced developments in the process of professional training of future specialists of socioeconomic professions in the conditions of adaptive training, contributes to the implementation of the principles of a personalized approach and increase the overall level of competitiveness. The article "The use of augmented reality technologies in the development of emotional intelligence of future specialists of socioeconomic professions under the conditions of adaptive learning" [71] by Viacheslav V. Osadchyi, Hanna B. Varina (figure 16), Kateryna P. Osadcha, Olha V. Kovalova, Valentyna V. Voloshyna, Oleksii V. Sysoiev and Mariya P. Shyshkina is devoted to the theoretical and empirical analysis of the features of the implementation of augmented reality technologies in the construct of traditional psychological and pedagogical support aimed at the development of

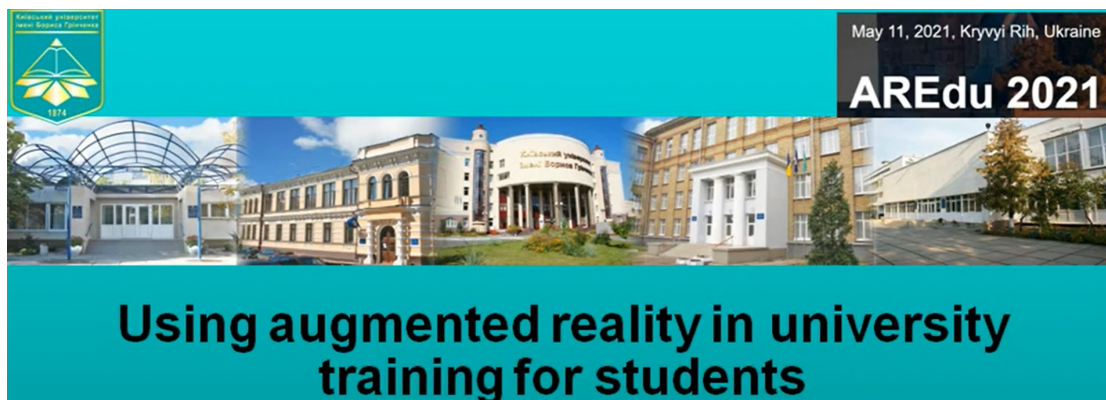

Figure 15: Presentation of paper [90].

emotional intelligence of the future specialist. The interdisciplinary approach was used while carrying out the research work at the expense of the general fund of the state budget: “Adaptive system for individualization and personalization of professional training of future specialists in the conditions of blended learning”. A comprehensive study of the implementation of traditional psychological-pedagogical and innovative augmented reality technologies was conducted in the framework of scientific cooperation of STEAM-Laboratory, Laboratory of Psychophysiological Research and Laboratory of Psychology of Health in Bogdan Khmelnytsky Melitopol State Pedagogical University. The theoretical analysis considers the structural model of emotional intelligence of the future specialist of socioeconomic professions, which is represented by two structural components: intrapersonal construct of emotional intelligence and interpersonal construct of emotional intelligence. Each component mediates the inherent emotional intelligence of interpretive, regulatory, adaptive, stress-protective and activating functions. The algorithm of the empirical block of research is presented by two stages: ascertaining and forming research. According to the results of the statement, low indicators were found on most scales, reflecting the general level of emotional intelligence development of future specialists, actualizing the need to find and implement effective measures for the development of emotional intelligence components in modern higher education and taking into account information development and digitalization. As part of the formative stage of the research implementation, a comprehensive program “Development of emotional intelligence of future professionals” was tested, which integrated traditional psychological and pedagogical technologies and innovative augmented reality technologies. This program is designed for 24 hours, 6 thematic classes of 4 hours. According to the results of a comprehensive ascertaining and shaping research, the effectiveness of the influence of augmented reality technologies on the general index of emotional intelligence is proved. The step-by-step model of integration of augmented reality components influencing the ability to analyze, understand and regulate emotional states into a complex program of emotional intelligence development is demonstrated. According to the results of the formative study, there is a dominance of high indicators of the following components: intrapersonal (50%), interpersonal (53.3%). Thus, we can say that intrapersonal and interpersonal emotional

intelligence together involve the actualization of various cognitive processes and skills, and are related to each other. Empirical data were obtained as a result of conducting a psychodiagnostic study on an innovative computer complex HC-psychotest.

This article highlights further research by the authors, begun in [91, 84, 85, 92, 93, 94, 95, 96, 97, 58].

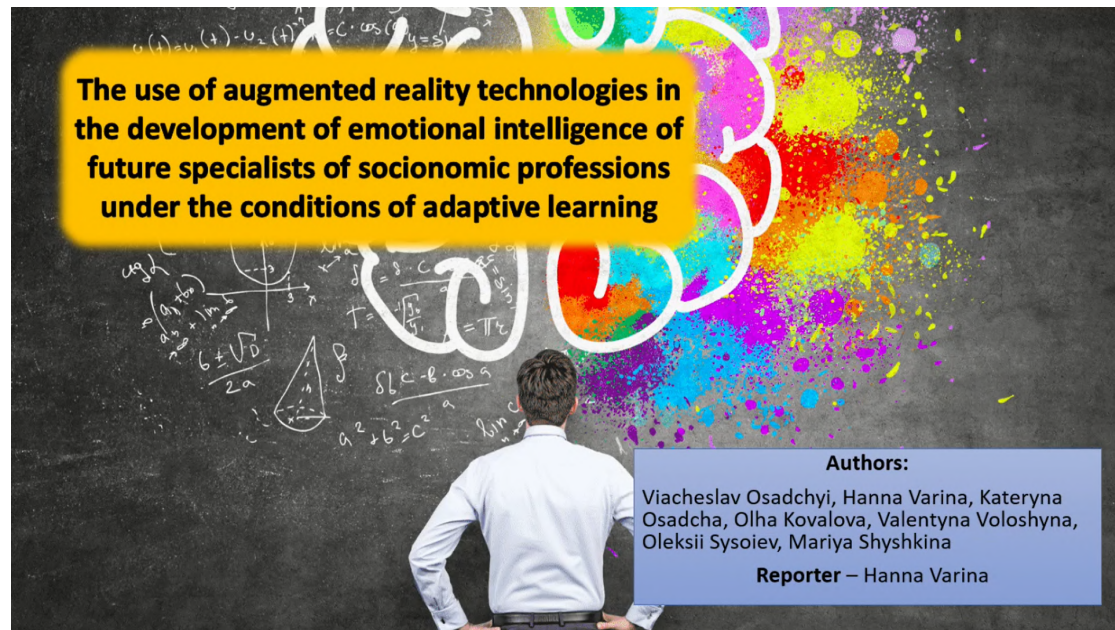

Figure 16: Presentation of paper [71].

The article “Development of the health-preserving competence of a physical education teacher on the basis of N. Bernstein’s theory of movements construction using virtual reality technologies” [70] by Mykola B. Yevtuch, Vasyl M. Fedorets, Oksana V. Klochko (figure 17), Mariya P. Shyshkina and Alla V. Dobryden studies the results of the research aimed at the improvement of the methodology of development of the health-preserving competence of a Physical Education teacher in conditions of post-graduate education on the basis of Nikolai Bernstein’s theory of movement construction using virtual reality technologies. Based on the use of AR/VR technologies a software application “Virtual Model Illustrating Nikolai Bernstein’s Theory of Movement Construction” was developed. The stated model is one of the tools of the “Methodology of development of the health preserving competence of a Physical Education teacher on the basis of Nikolai Bernstein’s theory of the levels of movement construction”. The experimental study determines that the application of the virtual model within the stated methodology is an effective tool for the development of the health preserving competence of a Physical Education teacher. The application of the virtual model allows the actualization of the health preserving, conceptual, gnoseological, biomechanical, inclusive, corrective potentials of Nikolai Bernstein’s theory of movement construction. The use of the virtual model presents the ways of targeted and meaningful use of Nikolai Bernstein’s theory of the levels of movement

construction by a Physical Education teacher and the improvement of physical and recreational technologies and concrete physical exercises and movement modes. Due to the application of virtual reality tools, health-preserving, preventative, corrective and developmental strategies are being formed among which the significant ones are: “Application of synergistic movements to adaptation to movement activity, and recreation”, “Application of spatial movements for actualization of the orientation and search activities and development of spatial thinking”, “Use of movements with a complicated algorithm for intellect development”.

This article highlights further research by the authors, begun in [98, 99].

Level B - “Synergistic movements“ (Virtual model - VM)

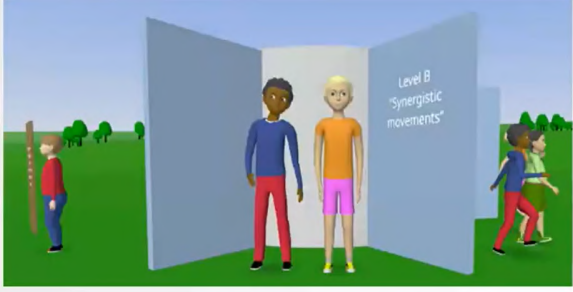

Movement: base walking and dancing (rhythmic), maintaining balance and balancing

Characteristic of movement: movements without taking into account the spatial structure of the environment, economical, balancing, stereotic, equilibrium, "pulsating", rhythmic, repetitive, smooth and precise, partially automatic, the basis of walking

Figure 3.
Space: your body and the immediate surrounding space

Figure 17: Presentation of paper [70].

The article “The usage of augmented reality technologies in professional training of future teachers of Ukrainian language and literature” [100] by Olha B. Petrovych, Alla P. Vinnichuk, Viktor P. Krupka, Iryna A. Zelenenka and Andrei V. Voznyak (figure 18) deals with the peculiarities of creation and practical application of augmented reality technologies for the organization of students-philologists’ individual and group work in studying the discipline “Methodic of teaching literature”. The relevance of the introduction of AR technologies for the future teachers-philologists’ readiness formation to the professional activity is substantiated. Analysis of the scientific sources suggested that the professional training process requires the modernization of teaching methods, and the usage of information and communication technologies (ICT) in education, in particular AR technologies, allows to make the learning process interesting and exciting. The domestic and foreign experience of AR technologies application into current educational practices is generalized. A step-by-step algorithm for creating the AR in the mobile application Unite and its subsequent content filling for professional training of future teachers of Ukrainian language and literature is described. The visualization of the educational content of the lep-book “Incredible Lesya Ukrainka”, made by students-philologists at the Mykhailo Stelmakh Faculty of Philology and Journalism of Vinnytsia Mykhailo Kotsiubynskyi State Pedagogical

University during the studying the discipline “Methodic of teaching literature”, is detailed. It is specified that the educational process is based on the creation AR with the visualization of interactive learning materials with animation, instructions, links, video content, illustrations etc. according to the rubrics of the lepbook. It is emphasized that the implementation of AR technologies provides the increasing of motivation for systematic mastering of practical skills, enhances students’ concentration and attention, increases their cognitive experience, promotes the development of their creative abilities, produces the opportunities of using the visualized content for students’ research work, stimulates them to self-expression, motivates them to self-development, trains them to the skillful use of the Internet, modern gadgets and mobile applications, etc. Prospects for studying the possibilities of using AR technologies in lessons of Ukrainian literature at secondary school are determined.

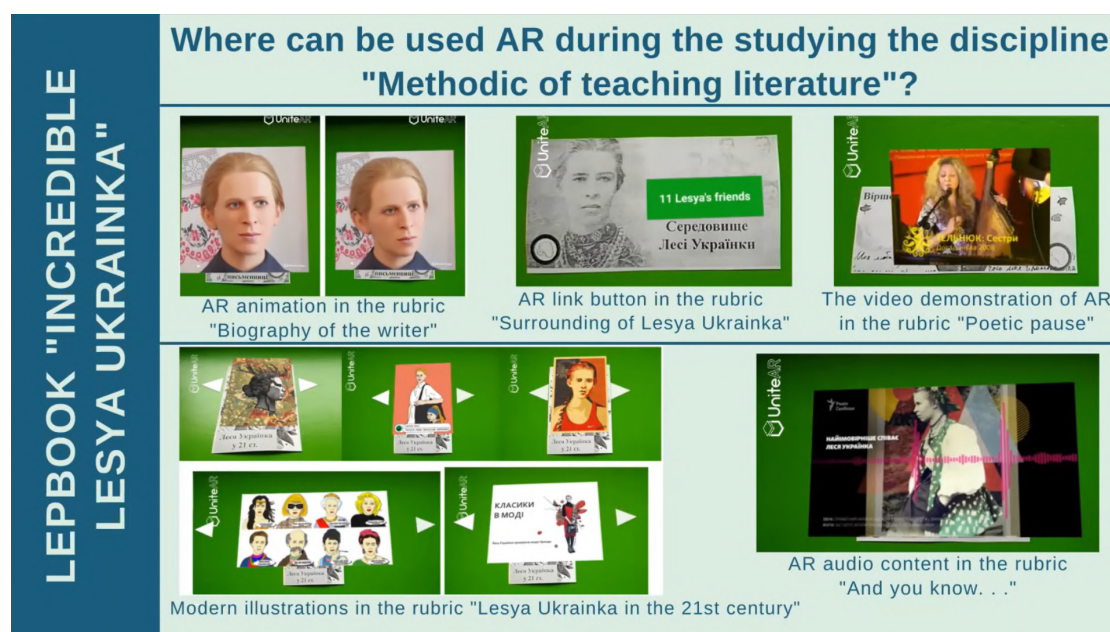

Figure 18: Presentation of paper [100].

The article ‘Formation of readiness of future teachers to use augmented reality in the educational process of preschool and primary education’ [101] by Svitlana P. Palamar (figure 19), Ganna V. Bielienska, Tatyana O. Ponomarenko, Liudmyla V. Kozak, Liudmyla L. Nezhyva and Andrei V. Voznyak substantiates the importance of training future teachers to use AR technologies in the educational process of preschool and primary education. Scientific sources on the problem of AR application in education are analyzed. Possibilities of using AR in work with preschoolers and junior schoolchildren are considered. Aspects of research of the problem of introduction of AR in education carried out by modern foreign and domestic scientists are defined, namely: use of AR-applications in education; introduction of 3D technologies, virtual and augmented reality in the educational process of preschool and primary school; 3D, virtual and augmented reality technologies in higher education; increase of the efficiency of learning and motivating students

through the use of AR-applications on smartphones; formation of reading culture by means of augmented reality technology; prospects for the use of augmented reality within the linguistic and literary field of preschool and primary education. The authors analyzed the specifics of toys with AR-applications, interactive alphabets, coloring books, encyclopedias and art books of Ukrainian and foreign writers, which should be used in working with children of preschool and primary school age; the possibilities of books for preschool children created with the help of augmented reality technologies are demonstrated. The relevance of the use of AR for the effective education and development of preschoolers and primary school children is determined. Problems in the application of AR in the educational process of modern domestic preschool education institutions are outlined. A method of diagnostic research of the level and features of readiness of future teachers to use AR in the educational process of preschool and primary education has been developed. Criteria, indicators are defined, the levels of development of the main components of the studied readiness (motivational, cognitive, activity) are characterized. The insufficiency of its formation in future teachers in the field of preschool and primary education; inconsistency between the peculiarities of training future teachers to use AR in professional activities and modern requirements for the quality of the educational process; the need to develop and implement a holistic system of formation of the studied readiness of future teachers in the conditions of higher pedagogical education are proved. A model of forming the readiness of future teachers to use AR in the educational process of preschool and primary education has been developed.

This article highlights further research by the authors, begun in [102].

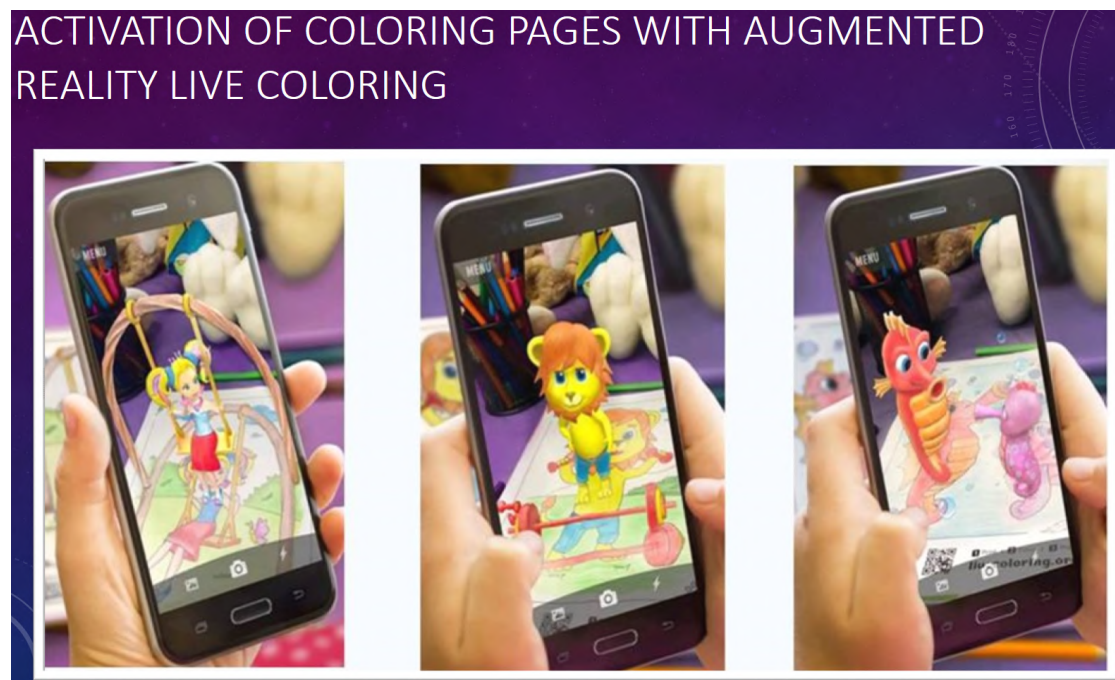

Figure 19: Presentation of paper [101].

3. Conclusion

The fourth installment of AREdu was organized by Kryvyi Rih National University (with support of the rector Mykola I. Stupnik) in collaboration with Kryvyi Rih State Pedagogical University (with support of the rector Yaroslav V. Shramko), Institute of Information Technologies and Learning Tools of the NAES of Ukraine (with support of the director Valeriy Yu. Bykov) and University of Educational Management (with support of the vice-rector for research and digitalization Oleg M. Spirin).

We are thankful to all the authors who submitted papers and the delegates for their participation and their interest in AREdu as a platform to share their ideas and innovation. Also, we are also thankful to all the program committee members for providing continuous guidance and efforts taken by peer reviewers contributed to improve the quality of papers provided constructive critical comments, improvements and corrections to the authors are gratefully appreciated for their contribution to the success of the workshop. Moreover, we would like to thank the developers of HotCRP, who made it possible for us to use the resources of this excellent and comprehensive conference management system, from the call of papers and inviting reviewers, to handling paper submissions, communicating with the authors, and creating the volume of the workshop proceedings.

We are looking forward to excellent presentations and fruitful discussions, which will broaden our professional horizons. We hope all participants enjoy this workshop and meet again in more friendly, hilarious, and happiness of further AREdu 2022.

References

- [1] A. Kiv, V. Soloviev, Preface, CEUR Workshop Proceedings 2257 (2018).
- [2] A. Kiv, M. Shyshkina, S. Semerikov, A. Striuk, Y. Yechkalo, AREdu 2019 – How augmented reality transforms to augmented learning, CEUR Workshop Proceedings 2547 (2020) 1–12.
- [3] O. Burov, A. Kiv, S. Semerikov, A. Striuk, M. Striuk, L. Kolgatina, I. Oliinyk, AREdu 2020 - How augmented reality helps during the coronavirus pandemic, CEUR Workshop Proceedings 2731 (2020) 1–46.
- [4] I. S. Mintii, T. A. Vakaliuk, S. M. Ivanova, O. A. Chernysh, S. M. Hryshchenko, S. O. Semerikov, Current state and prospects of distance learning development in Ukraine, CEUR Workshop Proceedings (2021) 41–55.
- [5] S. O. Semerikov, K. I. Slovak, Theory and method using mobile mathematical media in the process of mathematical education higher mathematics students of economic specialties, Information Technologies and Learning Tools 21 (2011). URL: <https://journal.iitta.gov.ua/index.php/itlt/article/view/413>. doi:10.33407/itlt.v21i1.413.
- [6] N. M. Kiianovska, N. V. Rashevskaya, S. O. Semerikov, Development of theory and methods of use of information and communication technologies in teaching mathematics of engineering specialties students in the united states, Information Technologies and Learning Tools 43 (2014) 68–83. URL: <https://journal.iitta.gov.ua/index.php/itlt/article/view/1128>. doi:10.33407/itlt.v43i5.1128.

- [7] M. A. Kyslova, S. O. Semerikov, K. I. Slovak, Development of mobile learning environment as a problem of the theory and methods of use of information and communication technologies in education, *Information Technologies and Learning Tools* 42 (2014) 1–19. URL: <https://journal.iitta.gov.ua/index.php/itlt/article/view/1104>. doi:10.33407/itlt.v42i4.1104.
- [8] O. M. Markova, S. O. Semerikov, A. M. Striuk, The cloud technologies of learning: origin, *Information Technologies and Learning Tools* 46 (2015) 29–44. URL: <https://journal.iitta.gov.ua/index.php/itlt/article/view/1234>. doi:10.33407/itlt.v46i2.1234.
- [9] Y. Modlo, S. Semerikov, Xcos on Web as a promising learning tool for Bachelor’s of Electromechanics modeling of technical objects, *CEUR Workshop Proceedings* 2168 (2017) 34–41. URL: <http://ceur-ws.org/Vol-2168/paper6.pdf>.
- [10] V. S. Morkun, S. O. Semerikov, S. M. Hryshchenko, Content and teaching technology of course ”Ecological geoinformatics” in training of future mining engineers, *Information Technologies and Learning Tools* 57 (2017) 115–125. URL: <https://journal.iitta.gov.ua/index.php/itlt/article/view/1549>. doi:10.33407/itlt.v57i1.1549.
- [11] V. Morkun, S. Semerikov, S. Hryshchenko, K. Slovak, Environmental geo-information technologies as a tool of pre-service mining engineer’s training for sustainable development of mining industry, *CEUR Workshop Proceedings* 1844 (2017) 303–310. URL: <http://ceur-ws.org/Vol-1844/10000303.pdf>.
- [12] I. Mintii, V. Soloviev, Augmented reality: Ukrainian present business and future education, *CEUR Workshop Proceedings* 2257 (2018) 227–231.
- [13] P. Nechypurenko, S. Semerikov, VlabEmbed - the new plugin Moodle for the chemistry education, *CEUR Workshop Proceedings* 1844 (2017) 319–326. URL: <http://ceur-ws.org/Vol-1844/10000319.pdf>.
- [14] O. Markova, S. Semerikov, M. Popel, CoCalc as a learning tool for neural network simulation in the special course ”Foundations of mathematic informatics”, *CEUR Workshop Proceedings* 2104 (2018) 388–403. URL: http://ceur-ws.org/Vol-2104/paper_204.pdf.
- [15] Y. Modlo, S. Semerikov, E. Shmeltzer, Modernization of professional training of electromechanics bachelors: ICT-based competence approach, *CEUR Workshop Proceedings* 2257 (2018) 148–172. URL: <http://ceur-ws.org/Vol-2257/paper15.pdf>.
- [16] A. Kiv, V. Soloviev, S. Semerikov, CTE 2018 – How cloud technologies continues to transform education, *CEUR Workshop Proceedings* 2433 (2019) 1–19.
- [17] O. Korotun, T. Vakaliuk, V. Oleshko, Development of a web-based system of automatic content retrieval database, *CEUR Workshop Proceedings* 2546 (2019) 182–197.
- [18] O. Markova, S. Semerikov, A. Striuk, H. Shalatska, P. Nechypurenko, V. Tron, Implementation of cloud service models in training of future information technology specialists, *CEUR Workshop Proceedings* 2433 (2019) 499–515. URL: <http://ceur-ws.org/Vol-2433/paper34.pdf>.
- [19] I. Mintii, S. Shokaliuk, T. Vakaliuk, M. Mintii, V. Soloviev, Import test questions into Moodle LMS, *CEUR Workshop Proceedings* 2433 (2019) 529–540.
- [20] Y. Modlo, S. Semerikov, P. Nechypurenko, S. Bondarevskyi, O. Bondarevska, S. Tolmachev, The use of mobile Internet devices in the formation of ICT component of bachelors in electromechanics competency in modeling of technical objects, *CEUR Workshop Proceedings* 2433 (2019) 413–428.

- [21] V. Ustinova, S. Shokaliuk, I. Mintii, A. Pikilnyak, Modern techniques of organizing computer support for future teachers' independent work in German language, CEUR Workshop Proceedings 2433 (2019) 308–321.
- [22] I. Mintii, Using Learning Content Management System Moodle in Kryvyi Rih State Pedagogical University educational process, CEUR Workshop Proceedings 2643 (2020) 293–305.
- [23] S. Pochtovyuk, V. Chernenko, T. Vakaliuk, Information and communication technologies in the study of mathematical methods in psychology, CEUR Workshop Proceedings 2732 (2020) 1249–1259.
- [24] A. Kiv, M. Shyshkina, S. Semerikov, A. Striuk, M. Striuk, H. Shalatska, CTE 2019 - When cloud technologies ruled the education, CEUR Workshop Proceedings 2643 (2020) 1–59. URL: <http://ceur-ws.org/Vol-2643/paper00.pdf>.
- [25] Y. Modlo, S. Semerikov, S. Bondarevskiy, S. Tolmachev, O. Markova, P. Nechypurenko, Methods of using mobile Internet devices in the formation of the general scientific component of bachelor in electromechanics competency in modeling of technical objects, CEUR Workshop Proceedings 2547 (2020) 217–240. URL: <http://ceur-ws.org/Vol-2547/paper16.pdf>.
- [26] Y. Modlo, S. Semerikov, R. Shajda, S. Tolmachev, O. Markova, P. Nechypurenko, T. Selivanova, Methods of using mobile Internet devices in the formation of the general professional component of bachelor in electromechanics competency in modeling of technical objects, CEUR Workshop Proceedings 2643 (2020) 500–534. URL: <http://ceur-ws.org/Vol-2643/paper30.pdf>.
- [27] V. Tkachuk, Y. Yechkalo, S. Semerikov, M. Kislova, V. Khotskina, Exploring student uses of mobile technologies in university classrooms: Audience response systems and development of multimedia, CEUR Workshop Proceedings 2732 (2020) 1217–1232. URL: <http://ceur-ws.org/Vol-2732/20201217.pdf>.
- [28] V. Tkachuk, S. Semerikov, Y. Yechkalo, S. Khotskina, V. Soloviev, Selection of mobile ICT for learning informatics of future professionals in engineering pedagogy, CEUR Workshop Proceedings 2732 (2020) 1058–1068. URL: <http://ceur-ws.org/Vol-2732/20201058.pdf>.
- [29] T. Vakaliuk, D. Antoniuk, A. Morozov, M. Medvedieva, M. Medvediev, Green IT as a tool for design cloud-oriented sustainable learning environment of a higher education institution, E3S Web of Conferences 166 (2020) 10013. doi:10.1051/e3sconf/202016610013.
- [30] T. Vakaliuk, A. Yefimenko, V. Bolotina, Y. Bailiuk, O. Pokotylo, S. Didkivska, Using Massive Open Online Courses in teaching the subject "Computer networks" to the future IT specialists, CEUR Workshop Proceedings 2732 (2020) 665–676.
- [31] A. V. Morozov, T. A. Vakaliuk, An electronic environment of higher education institution (on the example of zhytomyr polytechnic state university), Journal of Physics: Conference Series 1840 (2021) 012061. doi:10.1088/1742-6596/1840/1/012061.
- [32] T. A. Vakaliuk, O. M. Spirin, N. M. Lobanchykova, L. A. Martseva, I. V. Novitska, V. V. Kontsedailo, Features of distance learning of cloud technologies for the organization educational process in quarantine, Journal of Physics: Conference Series 1840 (2021) 012051. doi:10.1088/1742-6596/1840/1/012051.
- [33] S. O. Semerikov, M. P. Shyshkina, A. M. Striuk, M. I. Striuk, I. S. Mintii, O. O. Kalinichenko, L. S. Kolgatina, M. Y. Karpova, 8th Workshop on Cloud Technologies in Education: Report,

- CEUR Workshop Proceedings 2879 (2020) 1–69.
- [34] D. S. Antoniuk, T. A. Vakaliuk, V. V. Ievdokymov, A. V. Morozov, V. V. Kontsedailo, Integrating business simulations software into learning environment of technical university, *Journal of Physics: Conference Series* 1946 (2021) 012018. doi:10.1088/1742-6596/1946/1/012018.
- [35] L. A. Martseva, L. H. Movchan, T. A. Vakaliuk, D. S. Antoniuk, Applying CDIO-approach at technical universities, *Journal of Physics: Conference Series* 1946 (2021) 012013. doi:10.1088/1742-6596/1946/1/012013.
- [36] T. A. Vakaliuk, O. V. Korotun, S. O. Semerikov, The selection of cloud services for ER-diagrams construction in IT specialists databases teaching, *CEUR Workshop Proceedings* 2879 (2020) 384–397.
- [37] O. V. Zaika, T. A. Vakaliuk, A. V. Riabko, R. P. Kukharchuk, I. S. Mintii, S. O. Semerikov, Selection of online tools for creating math tests, *CEUR Workshop Proceedings* (2021) 82–106.
- [38] V. Tkachuk, Y. Yechkalo, S. Semerikov, M. Kislova, Y. Hladyr, Using Mobile ICT for Online Learning During COVID-19 Lockdown, in: A. Bollin, V. Ermolayev, H. C. Mayr, M. Nikitchenko, A. Spivakovsky, M. Tkachuk, V. Yakovyna, G. Zholtkevych (Eds.), *Information and Communication Technologies in Education, Research, and Industrial Applications*, Springer International Publishing, Cham, 2021, pp. 46–67.
- [39] Y. Y. Dyulicheva, D. A. Gaponov, R. Mladenović, Y. A. Kosova, The virtual reality simulator development for dental students training: a pilot study, *CEUR Workshop Proceedings* (2021) 56–67.
- [40] Y. Dyulicheva, Y. Kosova, A. Uchitel, The augmented reality portal and hints usage for assisting individuals with autism spectrum disorder, anxiety and cognitive disorders, *CEUR Workshop Proceedings* 2731 (2020) 251–262.
- [41] S. A. Voloshynov, F. M. Zhuravlev, I. M. Riabukha, V. V. Smolets, H. V. Popova, Application of VR technologies in building future maritime specialists' professional competences, *CEUR Workshop Proceedings* (2021) 68–81.
- [42] O. Dyagileva, N. Goridko, H. Popova, S. Voloshynov, A. Yurzhenko, Ensuring sustainable development of education of future maritime transport professionals by means of network interaction, *E3S Web of Conferences* 166 (2020) 10003. doi:10.1051/e3sconf/202016610003.
- [43] M. Lvov, H. Popova, Simulation technologies of virtual reality usage in the training of future ship navigators, *CEUR Workshop Proceedings* 2547 (2020) 50–65.
- [44] S. Voloshynov, H. Popova, A. Yurzhenko, E. Shmeltser, The use of digital escape room in educational electronic environment of maritime higher education institutions, *CEUR Workshop Proceedings* 2643 (2020) 347–359.
- [45] A. V. Ryabko, O. V. Zaika, R. P. Kukharchuk, T. A. Vakaliuk, Graph model of Fog Computing system, *CEUR Workshop Proceedings* 2850 (2021) 28–44. URL: <http://ceur-ws.org/Vol-2850/paper2.pdf>.
- [46] E. G. Fedorenko, N. V. Kaidan, V. Y. Velychko, V. N. Soloviev, Gamification when studying logical operators on the Minecraft EDU platform, *CEUR Workshop Proceedings* (2021) 107–118.
- [47] V. Velychko, E. Fedorenko, D. Kassim, Conceptual bases of use of free software in the

- professional training of pre-service teacher of mathematics, physics and computer science, CEUR Workshop Proceedings 2257 (2018) 93–102.
- [48] E. Fedorenko, V. Velychko, A. Stopkin, A. Chorna, V. Soloviev, Informatization of education as a pledge of the existence and development of a modern higher education, CEUR Workshop Proceedings 2433 (2019) 20–32.
- [49] A. Tokarieva, N. Volkova, I. Harkusha, V. Soloviev, Educational digital games: Models and implementation, CEUR Workshop Proceedings 2433 (2019) 74–89.
- [50] E. Fedorenko, V. Velychko, S. Omelchenko, V. Zaselskiy, Learning free software using cloud services, CEUR Workshop Proceedings 2643 (2020) 487–499.
- [51] T. Vakaliuk, V. Kontsedailo, D. Antoniuk, O. Korotun, S. Semerikov, I. Mintii, Using Game Dev Tycoon to develop professional soft competencies for future engineers-programmers, CEUR Workshop Proceedings 2732 (2020) 808–822. URL: <http://ceur-ws.org/Vol-2732/20200808.pdf>.
- [52] V. Y. Velychko, S. O. Omelchenko, I. A. Khyzhniak, E. G. Fedorenko, Developing and using open electronic educational resources in educational activities, Journal of Physics: Conference Series 1840 (2021) 012063. doi:10.1088/1742-6596/1840/1/012063.
- [53] V. Y. Velychko, E. H. Fedorenko, N. V. Kaidan, V. N. Soloviev, O. V. Bondarenko, The support of the process of training pre-service mathematics teachers by means of cloud services, CEUR Workshop Proceedings 2879 (2020) 318–332.
- [54] T. A. Vakaliuk, S. I. Pochtoviuk, Analysis of tools for the development of augmented reality technologies, CEUR Workshop Proceedings (2021) 119–130.
- [55] V. Hordiienko, G. Marchuk, T. Vakaliuk, A. Pikilnyak, Development of a model of the solar system in AR and 3D, CEUR Workshop Proceedings 2731 (2020) 217–238.
- [56] L. Panchenko, T. Vakaliuk, K. Vlasenko, Augmented reality books: Concepts, typology, tools, CEUR Workshop Proceedings 2731 (2020) 283–296.
- [57] S. Pochtoviuk, T. Vakaliuk, A. Pikilnyak, Possibilities of application of augmented reality in different branches of education, CEUR Workshop Proceedings 2547 (2020) 92–106.
- [58] D. S. Shepiliev, S. O. Semerikov, Y. V. Yechkalo, V. V. Tkachuk, O. M. Markova, Y. O. Modlo, I. S. Mintii, M. M. Mintii, T. V. Selivanova, N. K. Maksyshko, T. A. Vakaliuk, V. V. Osadchyi, R. O. Tarasenko, S. M. Amelina, A. E. Kiv, Development of career guidance quests using WebAR, Journal of Physics: Conference Series 1840 (2021) 012028. doi:10.1088/1742-6596/1840/1/012028.
- [59] D. S. Shepiliev, Y. O. Modlo, Y. V. Yechkalo, V. V. Tkachuk, M. M. Mintii, I. S. Mintii, O. M. Markova, T. V. Selivanova, O. M. Drashko, O. O. Kalinichenko, T. A. Vakaliuk, V. V. Osadchyi, S. O. Semerikov, WebAR development tools: An overview, CEUR Workshop Proceedings 2832 (2020) 84–93. URL: <http://ceur-ws.org/Vol-2832/paper12.pdf>.
- [60] Z. S. Seidametova, Z. S. Abduramanov, G. S. Seydametov, Using augmented reality for architecture artifacts visualizations, CEUR Workshop Proceedings (2021) 131–146.
- [61] L. Y. Midak, I. V. Kravets, O. V. Kuzyshyn, T. V. Kostiuk, K. V. Buzhdyhan, V. M. Lutsyshyn, I. O. Hladkoskok, A. E. Kiv, M. P. Shyshkina, Augmented reality while studying radio-chemistry for the upcoming chemistry teachers, CEUR Workshop Proceedings (2021) 147–158.
- [62] M. Popel, M. Shyshkina, The cloud technologies and augmented reality: The prospects of use, CEUR Workshop Proceedings 2257 (2018) 232–236.

- [63] A. Iatsyshyn, V. Kovach, V. Lyubchak, Y. Zuban, A. Piven, O. Sokolyuk, A. Iatsyshyn, O. Popov, V. Artemchuk, M. Shyshkina, Application of augmented reality technologies for education projects preparation, CEUR Workshop Proceedings 2643 (2020) 134–160.
- [64] L. Midak, I. Kravets, O. Kuzyshyn, K. Berladnyiuk, K. Buzhdyhan, L. Baziuk, A. Uchitel, Augmented reality in process of studying astronomic concepts in primary school, CEUR Workshop Proceedings 2731 (2020) 239–250.
- [65] L. Midak, I. Kravets, O. Kuzyshyn, J. Pahomov, V. Lutsyshyn, A. Uchitel, Augmented reality technology within studying natural subjects in primary school, CEUR Workshop Proceedings 2547 (2020) 251–261.
- [66] N. Rashevska, S. Semerikov, N. Zinonos, V. Tkachuk, M. Shyshkina, Using augmented reality tools in the teaching of two-dimensional plane geometry, CEUR Workshop Proceedings 2731 (2020) 79–90. URL: <http://ceur-ws.org/Vol-2731/paper03.pdf>.
- [67] M. Shyshkina, M. Marienko, Augmented reality as a tool for open science platform by research collaboration in virtual teams, CEUR Workshop Proceedings 2547 (2020) 107–116.
- [68] L. Y. Midak, I. V. Kravets, O. V. Kuzyshyn, L. V. Baziuk, K. V. Buzhdyhan, Specifics of using image visualization within education of the upcoming chemistry teachers with augmented reality technology, Journal of Physics: Conference Series 1840 (2021) 012013. doi:10.1088/1742-6596/1840/1/012013.
- [69] L. Y. Midak, I. V. Kravets, O. V. Kuzyshyn, L. V. Baziuk, K. V. Buzhdyhan, J. D. Pahomov, Augmented reality as a part of STEM lessons, Journal of Physics: Conference Series 1946 (2021) 012009. doi:10.1088/1742-6596/1946/1/012009.
- [70] M. B. Yevtuch, V. M. Fedorets, O. V. Klochko, M. P. Shyshkina, A. V. Dobryden, Development of the health-preserving competence of a physical education teacher on the basis of N. Bernstein’s theory of movements construction using virtual reality technologies, CEUR Workshop Proceedings (2021) 294–314.
- [71] V. V. Osadchyi, H. B. Varina, K. P. Osadcha, O. V. Kovalova, V. V. Voloshyna, O. V. Sysoiev, M. P. Shyshkina, The use of augmented reality technologies in the development of emotional intelligence of future specialists of socioeconomic professions under the conditions of adaptive learning, CEUR Workshop Proceedings (2021) 269–293.
- [72] S. O. Semerikov, M. M. Mintii, I. S. Mintii, Review of the course “Development of Virtual and Augmented Reality Software” for STEM teachers: implementation results and improvement potentials, CEUR Workshop Proceedings (2021) 159–177.
- [73] V. Pirohov, A. Horlo, I. Mintii, Software development of the algorithm of adapting of the website design for people with color-blindness, CEUR Workshop Proceedings 2292 (2018) 103–108.
- [74] O. Syrovatskyi, S. Semerikov, Y. Modlo, Y. Yechkalo, S. Zelinska, Augmented reality software design for educational purposes, CEUR Workshop Proceedings 2292 (2018) 193–225. URL: <http://ceur-ws.org/Vol-2292/paper20.pdf>.
- [75] R. O. Tarasenko, S. M. Amelina, S. O. Semerikov, V. D. Shynkaruk, Using interactive semantic networks as an augmented reality element in autonomous learning, Journal of Physics: Conference Series 1946 (2021) 012023. doi:10.1088/1742-6596/1946/1/012023.
- [76] N. V. Osypova, V. I. Tatochenko, Improving the learning environment for future mathe-

- mathematics teachers with the use application of the dynamic mathematics system GeoGebra AR, CEUR Workshop Proceedings (2021) 178–196.
- [77] N. Kushnir, N. Osypova, N. Valko, L. Kuzmich, Distance learning technologies in institution of higher education by means of LCMS Moodle, CEUR Workshop Proceedings 2732 (2020) 1152–1163.
- [78] N. Osypova, O. Kokhanovska, G. Yuzbasheva, H. Kravtsov, Augmented and virtual reality technologies in teacher retraining, CEUR Workshop Proceedings 2732 (2020) 1203–1216.
- [79] A. E. Kiv, V. V. Bilous, D. M. Bodnenko, D. V. Horbatovskyi, O. S. Lytvyn, V. V. Proshkin, The development and use of mobile app ar physics in physics teaching at the university, CEUR Workshop Proceedings (2021) 197–212.
- [80] A. Kiv, O. Merzlykin, Y. Modlo, P. Nechypurenko, I. Topolova, The overview of software for computer simulations in profile physics learning, CEUR Workshop Proceedings 2433 (2019) 352–362.
- [81] V. Bilous, V. Proshkin, O. Lytvyn, Development of AR-applications as a promising area of research for students, CEUR Workshop Proceedings 2731 (2020) 205–216.
- [82] D. Bodnenko, H. Kuchakovska, V. Proshkin, O. Lytvyn, Using a virtual digital board to organize student’s cooperative learning, CEUR Workshop Proceedings 2731 (2020) 357–368.
- [83] S. Malchenko, D. Mykoliuk, A. Kiv, Using interactive technologies to study the evolution of stars in astronomy classes, CEUR Workshop Proceedings 2547 (2020) 145–155.
- [84] V. Osadchyi, H. Chemerys, K. Osadcha, V. Kruhlyk, S. Koniukhov, A. Kiv, Conceptual model of learning based on the combined capabilities of augmented and virtual reality technologies with adaptive learning systems, CEUR Workshop Proceedings 2731 (2020) 328–340.
- [85] V. Osadchyi, H. Varina, K. Osadcha, O. Prokofieva, O. Kovalova, A. Kiv, Features of implementation of modern AR technologies in the process of psychological and pedagogical support of children with autism spectrum disorders, CEUR Workshop Proceedings 2731 (2020) 263–282.
- [86] V. Shamonia, O. Semenikhina, V. Proshkin, O. Lebid, S. Kharchenko, O. Lytvyn, Using the Proteus virtual environment to train future IT professionals, CEUR Workshop Proceedings 2547 (2020) 24–36.
- [87] Y. V. Kharchenko, O. M. Babenko, A. E. Kiv, Using Blippar to create augmented reality in chemistry education, CEUR Workshop Proceedings (2021) 213–229.
- [88] O. O. Popov, A. V. Iatsyshyn, A. V. Iatsyshyn, V. O. Kovach, V. O. Artemchuk, V. O. Gurieiev, Y. G. Kutsan, I. S. Zinovieva, O. V. Aliksieieva, V. V. Kovalenko, A. E. Kiv, Immersive technology for training and professional development of nuclear power plants personnel, CEUR Workshop Proceedings (2021) 230–254.
- [89] A. Iatsyshyn, V. Kovach, Y. Romanenko, I. Deinega, A. Iatsyshyn, O. Popov, Y. Kutsan, V. Artemchuk, O. Burov, S. Lytvynova, Application of augmented reality technologies for preparation of specialists of new technological era, CEUR Workshop Proceedings 2547 (2020) 181–200.
- [90] V. V. Babkin, V. V. Sharavara, V. V. Sharavara, V. V. Bilous, A. V. Voznyak, S. Y. Kharchenko, Using augmented reality in university education for future IT specialists: educational process and student research work, CEUR Workshop Proceedings (2021) 255–268.

- [91] H. Chemerys, V. Osadchyi, K. Osadcha, V. Kruhlyk, Increase of the level of graphic competence future bachelor in computer sciences in the process of studying 3D modeling, *CEUR Workshop Proceedings* 2393 (2019) 17–28.
- [92] V. Osadchyi, H. Varina, E. Prokofiev, I. Serdiuk, S. Shevchenko, Use of AR/VR technologies in the development of future specialists' stress resistance: Experience of STEAM-laboratory and laboratory of psychophysiological research cooperation, *CEUR Workshop Proceedings* 2732 (2020) 634–649.
- [93] S. Symonenko, N. Zaitseva, V. Osadchyi, K. Osadcha, E. Shmeltser, Virtual reality in foreign language training at higher educational institutions, *CEUR Workshop Proceedings* 2547 (2020) 37–49.
- [94] H. Varina, S. Shevchenko, The peculiarities of using the computer complex HC-psychotests in the process of psychodiagnosis of the level of development of future specialists' mental capacity, *E3S Web of Conferences* 166 (2020) 10025. doi:10.1051/e3sconf/202016610025.
- [95] V. V. Osadchyi, N. V. Valko, L. V. Kuzmich, Using augmented reality technologies for STEM education organization, *Journal of Physics: Conference Series* 1840 (2021) 012027. doi:10.1088/1742-6596/1840/1/012027.
- [96] V. Osadchyi, H. Varina, N. Falko, K. Osadcha, T. Katkova, The peculiarities of the usage of AR technologies in the process of hardiness of future professionals, *Journal of Physics: Conference Series* 1840 (2021) 012059. doi:10.1088/1742-6596/1840/1/012059.
- [97] V. V. Osadchyi, K. P. Osadcha, H. B. Varina, S. V. Shevchenko, I. S. Bulakh, Specific features of the use of augmented reality technologies in the process of the development of cognitive component of future professionals' mental capacity, *Journal of Physics: Conference Series* 1946 (2021) 012022. doi:10.1088/1742-6596/1946/1/012022.
- [98] O. Klochko, V. Fedorets, A. Uchitel, V. Hnatyuk, Methodological aspects of using augmented reality for improvement of the health preserving competence of a Physical Education teacher, *CEUR Workshop Proceedings* 2731 (2020) 108–128.
- [99] O. Klochko, V. Fedorets, O. Maliar, V. Hnatyuk, The use of digital models of hemodynamics for the development of the 21st century skills as a components of healthcare competence of the physical education teacher, *E3S Web of Conferences* 166 (2020) 10033. doi:10.1051/e3sconf/202016610033.
- [100] O. B. Petrovych, A. P. Vinnichuk, V. P. Krupka, I. A. Zelenenka, A. V. Voznyak, The usage of augmented reality technologies in professional training of future teachers of Ukrainian language and literature, *CEUR Workshop Proceedings* (2021) 315–333.
- [101] S. P. Palamar, G. V. Bielenka, T. O. Ponomarenko, L. V. Kozak, L. L. Nezhyva, A. V. Voznyak, Formation of readiness of future teachers to use augmented reality in the educational process of preschool and primary education, *CEUR Workshop Proceedings* (2021) 334–350.
- [102] L. Nezhyva, S. Palamar, O. Lytvyn, Perspectives on the use of augmented reality within the linguistic and literary field of primary education, *CEUR Workshop Proceedings* 2731 (2020) 297–311.

Current state and prospects of distance learning development in Ukraine

Iryna S. Mintii^{1,2}, Tetiana A. Vakaliuk^{3,2,1}, Svitlana M. Ivanova², Oksana A. Chernysh³, Svitlana M. Hryshchenko⁴ and Serhiy O. Semerikov^{1,2,4,5}

¹Kryvyi Rih State Pedagogical University, 54 Gagarin Ave., Kryvyi Rih, 50086, Ukraine

²Institute of Information Technologies and Learning Tools of the NAES of Ukraine, 9 M. Berlynskoho Str., Kyiv, 04060, Ukraine

³Zhytomyr Polytechnic State University, 103 Chudrivska Str., Zhytomyr, 10005, Ukraine

⁴Kryvyi Rih National University, 11 Vitalii Matusevych Str., Kryvyi Rih, 50027, Ukraine

⁵University of Educational Management, 52-A Sichovykh Striltsiv Str., Kyiv, 04053, Ukraine

Abstract

The article presents a thorough literature review and highlights the main stages in the development of distance learning in Ukraine. Moreover, the paper suggests the periodization of distance learning. Research data on distance learning peculiarities in Ukraine during and before the pandemic make it possible to outline the main problems faced by higher education institutions' (HEIs) teachers and students. Therefore, the study emphasizes common problems, namely hardware/software issues, poor Internet connectivity, lack of students' self-discipline and self-organization, absence of live communication, insufficient digital literacy skills etc. The paper analyzes the benefits of MOOCs that aim at digital competence development. It presents the results of students' survey on qualitative changes in distance learning organization in 2020–2021 academic year compared to 2019–2020 academic year. The results prove that in current academic year, distance learning is better organized due to a sufficient structure of distance learning courses, the use of one platform for the whole educational institution, higher teachers' digital competence, the use of various resources etc.

Keywords

distance learning, MOOC, problems, digital competence

AREdu 2021: 4th International Workshop on Augmented Reality in Education, May 11, 2021, Kryvyi Rih, Ukraine

✉ irina.mintiy@kdpu.edu.ua (I. S. Mintii); tetianavakaliuk@gmail.com (T. A. Vakaliuk); iv-svetlana@iitlt.gov.ua (S. M. Ivanova); chernyshoxana@gmail.com (O. A. Chernysh); aspirodoc@gmail.com (S. M. Hryshchenko); semerikov@gmail.com (S. O. Semerikov)

🌐 <https://kdpu.edu.ua/personal/ismintii.html> (I. S. Mintii); <https://sites.google.com/view/neota> (T. A. Vakaliuk);

<https://iitlt.gov.ua/structure/departments/science/detail.php?ID=51> (S. M. Ivanova);

<https://ztu.edu.ua/ua/structure/pv/> (O. A. Chernysh);

<https://www.scopus.com/authid/detail.uri?authorId=56375301300> (S. M. Hryshchenko);

<https://kdpu.edu.ua/semerikov> (S. O. Semerikov)

🆔 0000-0003-3586-4311 (I. S. Mintii); 0000-0001-6825-4697 (T. A. Vakaliuk); 0000-0002-3613-9202 (S. M. Ivanova);

0000-0002-2010-200X (O. A. Chernysh); 0000-0003-4957-0904 (S. M. Hryshchenko); 0000-0003-0789-0272

(S. O. Semerikov)

© 2021 Copyright for this paper by its authors.
Use permitted under Creative Commons License Attribution 4.0 International (CC BY 4.0).



CEUR Workshop Proceedings (CEUR-WS.org)

1. Introduction

One of the major goals of sustainable development is to “ensure quality education and promote opportunities for all to learn throughout life” [1]. Taking into consideration the quarantine restrictions and the epidemiological situation, this goal is now possible only with the use of distance learning information technologies.

In March 2020, all educational institutions jointly implemented distance learning (distance learning). Initially, distance learning organization was quite disorganized. However, secondary education institutions quickly agreed on the platform for the whole institution, whereas in HEIs, even despite the availability of the platform to support distance learning, the choice of what technologies to use was first and foremost granted to teachers. Therefore, the variety of platforms used led to students’ frustration and negatively contributed to quality distance learning. Moreover, it also provoked teachers’ disorientation in distance learning organization and led to both technological as well as psychological problems. Consequently, solving these problems requires comprehensive distance learning study.

2. Theoretical background

Scopus database review for the query (KEY (e-learning) OR KEY (distance AND learning) OR KEY (blended AND learning)) (figure 1) shows a steady increase in the interest of distance learning among outstanding foreign and Ukrainian scholars (figure 2). Thus, Lviv Polytechnic National University, Kharkiv National University of Radio Electronics, Kherson State University, Borys Hrinchenko Kyiv University, National Technical University of Ukraine “Igor Sikorsky Kyiv Polytechnic Institute”, National Academy of Pedagogical Sciences of Ukraine, and Kryvyi Rih State Pedagogical University take the lead in this direction (figure 3).

The spring of 2020 has become decisive for distance learning. Therefore, the results of distance learning study after this period deserves special attention. Thus, in [2] distance learning is viewed as a three-dimensional learning model based on the principles of acquiring knowledge “anywhere”, “anytime” and “at any speed”. Moreover, the study presents the results of students’ survey on distance learning peculiarities which was conducted by the Department of Foreign Languages at the Prydniprovskya State Academy of Civil Engineering and Architecture (PSACEA) and at Alfred Nobel University (Dnipro) in March-May, 2020. A similar issue is analyzed in [3]. Thus the research suggests the results of teachers and students’ survey on the peculiarities of distance learning organization performed at Ternopil Volodymyr Hnatiuk National Pedagogical University and Dragomanov National Pedagogical University. Some studies propose [4] the analysis of distance learning problems. It is interesting to compare these results with teachers’ survey, which was conducted just before the introduction of the quarantine in Kryvyi Rih State Pedagogical University [5, 6]. The researchers have also addressed the problems of design and implementation of distance course “Cloud technologies in the educational process in quarantine” [7], MOOC advantages, classification, popularity and promotion [8] and others.

Some studies are dedicated to the peculiarities of distance learning information technologies use on the basis of Google Classroom [9] or Moodle LMS [10].

Thus, nowadays, identifying distance learning problems and finding the ways to solve them

Documents by year

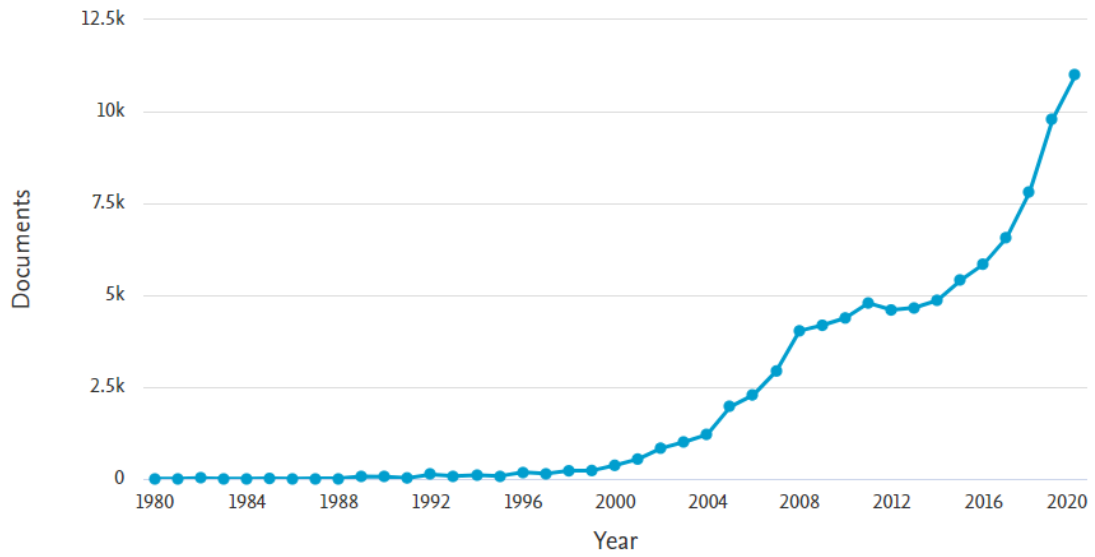

Figure 1: Number of papers included in Scopus by their publication year.

Documents by year

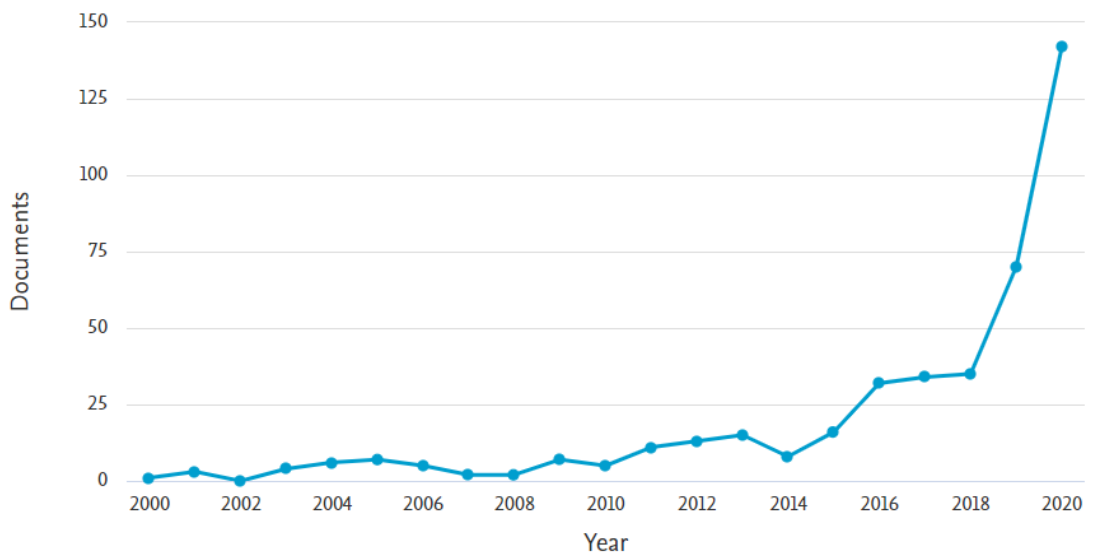

Figure 2: Number of papers included in Scopus by their publication year, AFFILCOUNTRY (Ukraine).

Documents by affiliation

Compare the document counts for up to 15 affiliations.

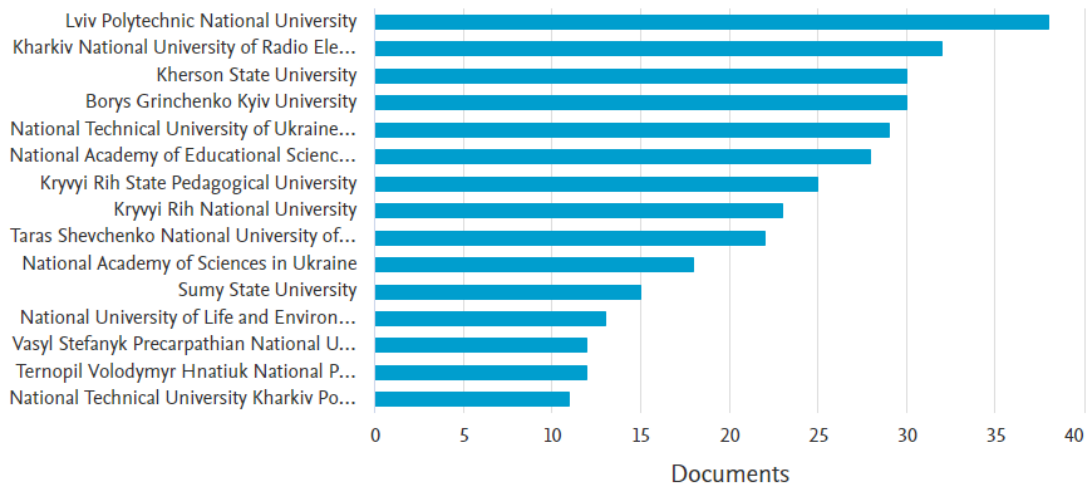

Figure 3: Number of papers included in Scopus by their publication year by affiliation.

are among the most widely discussed and investigated issues worldwide.

3. Methodology

The aim of the study is to analyze the current state of distance learning in Ukraine, identify its main problems and specify the ways to solve them. Therefore, the paper presents the analysis of the main stages of distance learning development in Ukraine and determines its periodization. Moreover, it summarizes the main problems associated with the organization of distance learning in HEIs in Ukraine on the basis of current research results [2, 3, 4, 5, 6].

As one of the problems of distance learning implementation, mentioned by HEIs teachers, is a low level of digital competence, the experience of MOOC courses should be taken into consideration for its further development.

Therefore, the paper considers the history of MOOC courses development in Ukraine and analyzes MOOC courses aimed at digital competence development. In addition, the study presents the results of HEIs students' survey on distance learning peculiarities.

The aim of the survey was to find out whether there were any qualitative changes in distance learning organization in 2020–2021 academic year compared to 2019–2020 academic year. What is more, it was necessary to identify the factors which contributed to quality changes. The survey was conducted at Kryvyi Rih State Pedagogical University among the 2nd-4th year Bachelor degree students and the 1st year Master degree students of the Faculty of Physics and Mathematics.

4. Results

4.1. History of distance learning in Ukraine

The history of distance learning in Ukraine could be roughly divided into the following stages:

Stage I: Introduction

- distance learning introduction at the National Technical University “Kharkiv Polytechnic Institute”, Kharkiv National University of Radio Electronics and Lviv Institute of Management (1997) [11];

Stage II: Popularization

- foundation of the Ukrainian Distance Education Center on the basis of the National Technical University of Ukraine “Igor Sikorsky Kyiv Polytechnic Institute” (2000) [12];
- approval of the Regulation “Concept of distance education development in Ukraine” (2000) [13];
- fostering the introduction and use of distance learning technologies, establishing centers of distance learning systems on the basis of educational institutions of different types (after 2000) in particular;
- approval of the “Regulations on distance learning” (2004) [14];
- approval of the new “Regulations on distance learning” (2013) [15];

Stage III: Widespread implementation

- widespread distance learning introduction in educational institutions of all levels due to quarantine restrictions related to COVID-19 (spring 2020);
- approval of the order “On distance learning organisation” (2020) [16].

According to the Regulation on distance learning, “the aim of distance learning is to provide educational services through the use of modern ICT in teaching at certain educational or educational and qualification levels in accordance with state educational standards; according to the programs of citizens’ preparation for admission to educational institutions, training of foreigners and advanced training of employees” [15].

4.2. State of distance learning

Moodle LMS is a common platform for distance / blended learning due to its wide range of features and simple interface. The modular structure of Moodle LMS allows to easily modify the design. Moreover, it has more than 40 language packs available to localize the system.

The results of Internet resources analysis (of May 2020) prove that the vast majority (86%) of Ukrainian educational institutions provide training in pedagogical specialties using Moodle LMS [17].

4.3. The analysis of distance learning problems

According to the annual report of the National Agency for Quality Assurance in Higher Education [18], the level of computer support for higher education is highly rated (4.07 with a 5-point scale, where 4 is rather good, 5 is very good).

Countries engagement in the use of information technology is expressed by the Network Readiness Index (NRI).

Thus, this research model focuses on four categories, such as technology, people, management, influence, and covers a wide range of issues from artificial intelligence and the Internet of Things to the role of digital transformation in achieving sustainable development goals (figure 4).

In 2020, in the context of “The Network Readiness Index 2020” survey [19] 134 countries were analyzed on 60 indicators. Ukraine is on the 64 th place with the value of NRI = 49.43 (figure 4). It is among Mexico, Belarus, Azerbaijan, Northern Macedonia, and Georgia. At the same time, Ukraine is among the top 3 countries in terms of NRI with below-average incomes (along with Vietnam and Moldova). The analysis of figure 4 outlines the weaknesses in the readiness to use information technology.

Ukraine

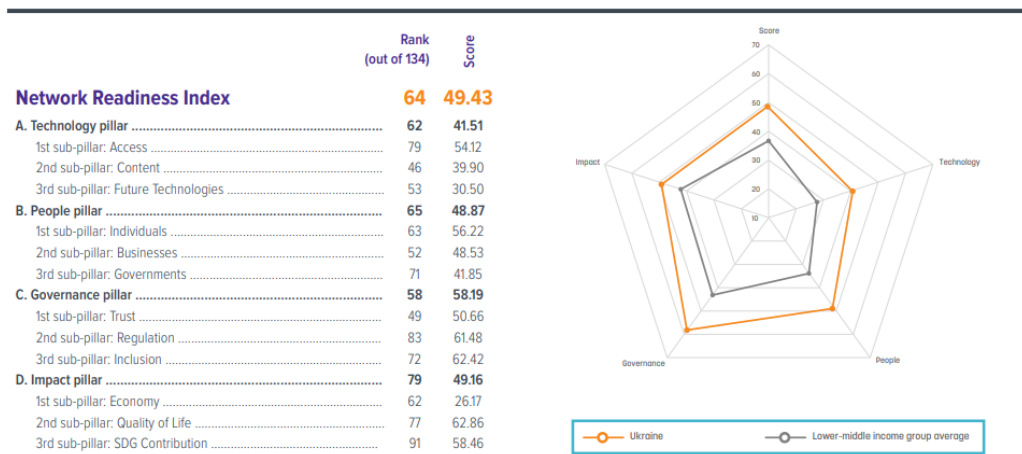

Figure 4: NRI Ukraine Index.

The study [19] emphasizes that “the world is ready for the Internet”. However, it raises the question whether the network is ready for that [19]. Nowadays, when social distancing has become the norm, only 4.5 billion people (59% of the world population) have a network connection. Although these indicators are significant, especially compared to 5–10 years ago, it should be noted that the growth rate of penetration has decreased. Consequently, at such a rate it will take 50 years or more to connect the whole world to the network [19]. Therefore, the authors of [19] see a new architecture for the next stage of development – the digital network Next-Gen Digital Network. It will be built in a fundamentally different way, combining four

specialized technological connections: wired and wireless, software and hardware, connection and computing, and open source.

Bakhmat et al. [4] analyzes the results of a survey of HEIs' teachers on distance learning. Particular attention is given to the following questions:

- Did you receive technical support / recommendations for organizing online teaching of your course (from HEI, technical support, etc.)?
- What problems did you face when organizing and conducting online classes?
- What are the benefits of online learning for you?

The results of the survey show that due to significant differences in the curricula of HEIs, the respondents did not receive clear recommendations from the Ministry of Education and Science on the organization of distance learning during the quarantine. On the other hand, secondary education institutions were given better support, namely regular lessons on TV channels, YouTube channel, approval of "The Regulations on the distance form of getting full secondary education", etc.). Therefore, the management of HEIs had almost unlimited freedom. Consequently, it led to sufficient differences in distance learning organization.

The results of the survey show that the majority (60%) of respondents received technical support / recommendations for organizing their online courses. However, the teachers emphasized the following distance learning organization problems (table 1).

Table 1

The problems of teachers in distance learning (Kharkiv region, Kyiv, Ternopil and Poltava regions)

№	Problem	%
1	low quality / lack of network connection	31
2	technical problems	10
3	insufficient student engagement	8
4	lack of eye interaction	6
5	low level of digital competence	4
6	lack of HEIs'	4
7	significant workload and stress	3
8	lack of students' motivation	3

These data correlate with the results of the study [17] on Moodle LMS use problems, namely lack of time, low level of digital competence, inadequate hardware and software.

It is important to emphasize the advantages of online learning, such as the efficiency of time use; quick access to classes; flexible schedule; variety of means; mobility, clear assessment; individualization and inclusiveness; possibility to invite experts to online courses etc.

Tokarieva et al. [2, p. 5] analyzes students' main problems in distance learning (table 2).

The survey results [3] help to identify the problems of both HEIs teachers and students in distance learning (table 3).

According to the survey conducted just before the quarantine in March 2020 at the Kryvyi Rih State Pedagogical University [5, p. 375], [6, p. 301], among the problems of using distance learning information technology (Moodle LMS in particular) the teachers emphasized technical difficulties, namely:

Table 2

The main problems of students in distance learning (I – Prydniprovska State Academy of Civil Engineering and Architecture, II – Alfred Nobel University)

Nº	Problems	I (%)	II (%)
1	Problems with self-organisation, high level of distraction	35	33
2	The excessive number of educational tasks	35	31
3	Dependence on technical means	87	28
4	Poor quality of home Internet	61	28
5	Restrictions on obtaining practical skills	22	27
6	Lack of opportunity to communicate freely with the teacher	0	23
7	Lack of control over the level of knowledge	13	18
8	Insufficient duration of classes (time limit)	0	15
9	The quality of the material taught	17	12
10	Insufficient theoretical materials to perform tests and/or tasks	30	10
11	Lack of opportunity to communicate with other students	57	10
12	The need to learn how to work online	13	5

Table 3

The main problems of both teachers and students in distance learning

Nº	Students	%	Academic staff	%
1	Self-motivation	75	Positive attitude towards ICT	69
2	Lack of practice	73	English language proficiency	65
3	Time management	61	Media literacy	65
4	Adaptability struggle	61	Instruction strategy	61
5	Lack of attention	61	Learner's capability	54
6	Anxiety & confusion	52	Digital alienation	54
7	English language proficiency	52	Up-to-date meaningful content of e-courses	52

- lack of Internet connection,
- limited software functionality for solving didactic tasks,
- instability of distance learning information technologies, and
- lack or inconsistency of teachers' technical support.

Moreover, the respondents highlighted organizational and methodological difficulties, such as:

- low level of teachers and students digital competence,
- insufficient development of distance learning theoretical and methodological principles,
- the use of information technology in educational process, and
- psychological unwillingness of some teachers to use information technology.

Therefore, the analysis of survey results makes it possible to emphasize the need to develop both students and teachers digital competence.

4.4. History of MOOC development in Ukraine

Taking into consideration the importance of social distancing, it is important to consider the experience of using Massive open online courses (MOOC) to develop digital competence. Therefore, the paper outlines the history of MOOC development in Ukraine.

The first MOOC was created at Taras Shevchenko National University of Kyiv “University Online” in 2013. The first MOOC was created on brand management by Ivan Primachenko (9000 participants) [11].

In 2014, platforms for online courses EdEra (developers: Ilia Filipov, Artem Ilchuk, Olga Filipova) and Prometheus (developers: Ivan Prymachenko, Oleksii Molchanovskyi) were created. Currently, 70+ courses are available on EdEra, and 200+ courses are available on Prometheus, which have already been completed by more than 1.5 million people who received 800,000 certificates.

2016 is characterized by the implementation of blended education pilot programs in the National Technical University of Ukraine “Igor Sikorsky Kyiv Polytechnic Institute”, Lviv National University named after Ivan Franko, National University “Lviv Polytechnic” and the Ukrainian Catholic University: introduction of courses from Prometheus to full-time study [20].

However, it should be noted that the first prototypes of MOOC in Ukraine were courses “Fundamentals of Distance Learning” (1999, 50 students), “Practical Distance Learning Course” (2000–2001, 60 students) developed by Volodymyr M. Kukhareenko [21].

Currently, there are a lot of Ukrainian-language online courses for teachers, namely: “Technology of distance course development-2021” [12], “The expertise of distance course-2021” [22] at National Technical University “Kharkiv Polytechnic Institute”; “Cloud technologies in distance learning in quarantine” [23] at Zhytomyr Polytechnic State University and others [17].

2020 was a very fruitful year for MOOC development. Thus, EdEra platform [24] has a number of courses on distance learning and the use of distance learning ICT in quarantine. The courses are developed for school teachers, teachers of vocational education institutions, teachers and employees of HEIs’ administration:

- online course on distance learning for teachers and school leaders [25] (August 2020);
- online course on distance learning for teachers and the principals of vocational education institutions [26] (August 2020);
- “Take it and do it” Blended and distance learning [27] (November 2020);
- #blend_it: We master blended learning [28] (January 2021).

At the beginning of the quarantine, the Ministry of Education and Science of Ukraine developed a project “Diia. Digital Education” [29]. It introduced a lot of series for teachers, which are also aimed at digital competence development:

- educational series “Quarantine: online services for teachers” [30];
- teachers’ digital skills [31];
- interactive learning: tools and technologies for interesting lessons [32];
- training for coaches [33].

However, these courses are mostly for HEIs pedagogical staff. Thus, such courses development is a perspective direction for further research. However, the development of such courses is needed for HEIs managers. Although statistics show that such courses (for heads of departments, deans, etc.) are not popular (table 4) and, as a result, distance learning process in most educational institutions is unmanageable [11]. Therefore, special attention should be given to this issue.

Table 4

Course statistics for heads of departments, deans, etc.

Course	Registered	Studied	Completed
Basics of distance learning	1652	363	65
Distance course development technologies	1368	488	194
Blended learning	396	125	52
Tutors' workshop	210	53	24
Content curator	460	213	85
Distance learning for managers	131	30	14

The experience of the European Union can be used to solve the issue of distance learning implementation, namely: Open University (United Kingdom) [34], National University of Distance Education (Universidad Nacional de Educación a Distancia) (Spain) [35], National Center for Distance Education (Center national d'enseignement à distance (CNED)) (France) [36] etc.

Thus, the aim of CNED lies in the maximum implementation of distance education and presupposes establishing courses for learners from kindergarten to HEIs. Moreover, it provides vocational education, inclusive education, elective courses, summer courses, HEIs admission courses. What is more, it proposes certified training sessions; exams preparation for replacement positions, educational institutions consultation, adaptation of existing courses for a specific customer; training in the fields of culture, art, sports, medicine, etc.

Another way to improve distance learning implementation is to ensure the appropriate level of IT infrastructure.

4.5. Determining qualitative changes in distance learning organization

To identify the changes in distance learning organization in 2020–2021 academic year compared to 2019–2020 academic year we conducted a survey among the students of the Faculty of Physics and Mathematics of Kryvyi Rih State Pedagogical University. The survey included the following questions:

1. *How did distance learning organization change in 2020-2021 academic year compared to 2019-2020 academic year?* (the results are presented in the figure 5).

2. *Has teachers' digital competence in 2020-2021 compared to 2019-2020 academic year changed?* (the results are presented in the figure 6).

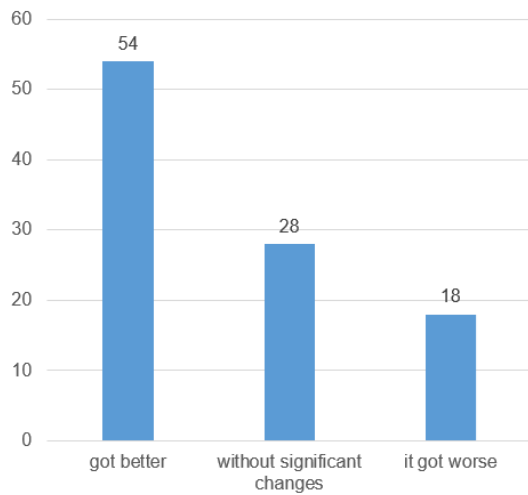

Figure 5: Changing the distance learning organisation.

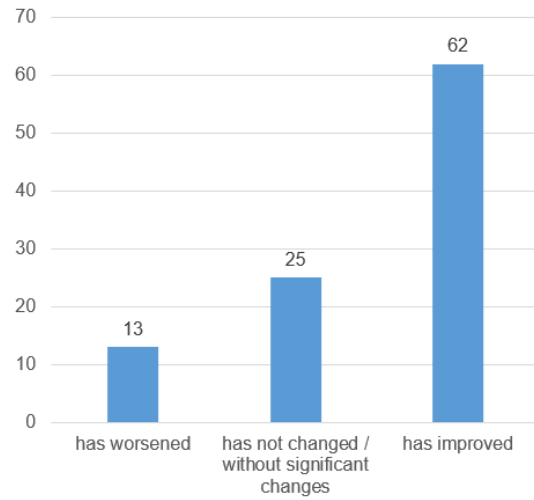

Figure 6: Changing the teachers' digital competence.

3. Choose the factors which are important to facilitate distance learning process? (the results are presented in the figure 7).

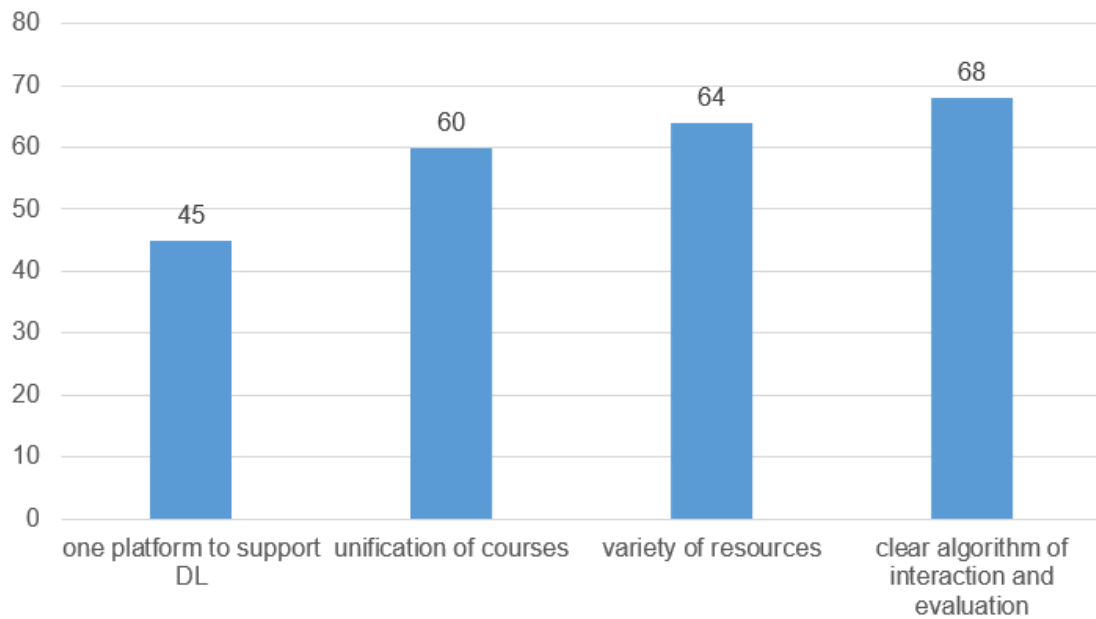

Figure 7: Important factors for facilitating distance learning.

4. *What form of education would you prefer?* (the results are presented in the figure 8).

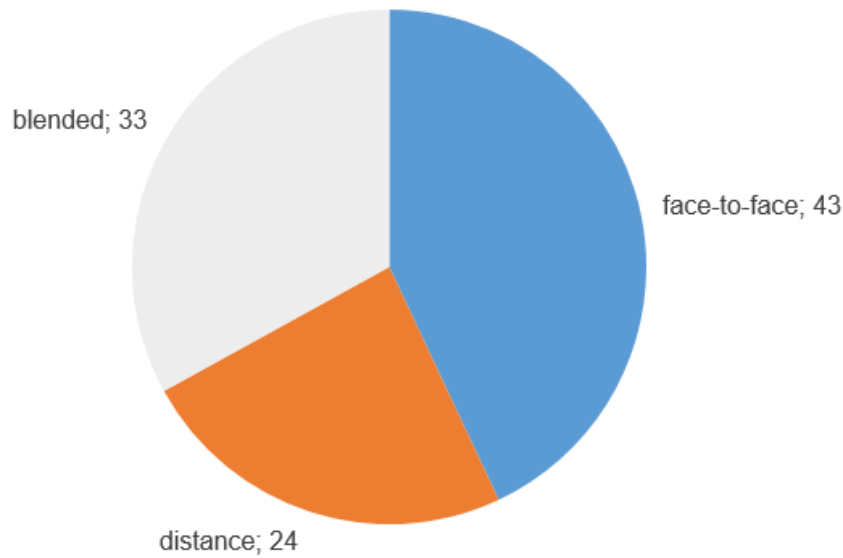

Figure 8: Preferred form of education.

5. *Your comment about distance learning.*

It's interesting to cite the students' answers:

It got better, as teachers supported learning through Moodle LMS system throughout the course. They introduced the main tasks to be done and set the deadlines.

All teachers use one platform, which allows you to navigate faster.

A variety of resources facilitate the understanding of the material. The use of MOOC by teachers helps to master the course at a significantly higher level as you understand that this is a course that is studied all over the world, and your results meet world standards.

5. Conclusions

The COVID-19 quarantine restrictions have become a catalyst for the use of distance learning technologies in all educational institutions and a litmus test to identify the problems associated with it. Despite HEIs high self-assessment on computer software stated in the reports of the National Agency for Quality Assurance in Higher Education [18], there are a lot of problems related to distance learning. Thus among the main problems teachers and students emphasize hardware / software inconsistencies and technical problems with the Internet.

In addition, they highlight the importance of developing both teachers and students digital competence. It may be facilitated by the MOOC, the significance of which is highly appreciated by both non-governmental organization and the Ministry of Education and Science of Ukraine. Due to their cooperation a number of courses have already been developed both for training and for determining the level of digital literacy.

The other problems, namely problems with self-organization, high level of distraction, restrictions on obtaining practical skills, lack of opportunity to communicate freely with the teacher, lack of control over the level of knowledge, insufficient theoretical materials to perform tests and / or tasks, can be solved through blended learning.

The results of a survey conducted to identify changes in distance learning organization in 2020–2021 academic year compared to 2019–2020 academic year prove a better distance learning organization which became possible thank to by higher level of teachers' digital competence, the use of one platform within the educational institution and the use of a variety of resources, including MOOC.

References

- [1] Transforming our world: the 2030 Agenda for Sustainable Development, 2020. URL: <https://sdgs.un.org/2030agenda>.
- [2] A. V. Tokarieva, N. P. Volkova, Y. V. Degtyariova, O. I. Bobyr, E-learning in the present-day context: from the experience of foreign languages department, PSACEA, *Journal of Physics: Conference Series* 1840 (2021) 012049. doi:10.1088/1742-6596/1840/1/012049.
- [3] H. I. Falfushynska, B. B. Buyak, H. V. Tereshchuk, G. M. Torbin, M. M. Kasianchuk, Strengthening of e-learning at the leading Ukrainian pedagogical universities in the time of COVID-19 pandemic, *CEUR Workshop Proceedings* 2879 (2020) 261–273. URL: <http://ceur-ws.org/Vol-2879/paper13.pdf>.
- [4] L. Bakhmat, O. Babakina, Y. Belmaz, Assessing online education during the COVID-19 pandemic: a survey of lecturers in Ukraine, *Journal of Physics: Conference Series* 1840 (2021) 012050. doi:10.1088/1742-6596/1840/1/012050.
- [5] I. Mintii, O. Bondarenko, S. Shokaliuk, K. Polhun, M. Mintii, Analysis of the use of LCMS Moodle in the educational process of KrSPU, *Educational Dimension* (2020) 368–383. doi:10.31812/educdim.v55i0.43660.
- [6] I. Mintii, Using Learning Content Management System Moodle in Kryvyi Rih State Pedagogical University educational process, *CEUR Workshop Proceedings* 2643 (2020) 293–305. URL: <http://ceur-ws.org/Vol-2643/paper17.pdf>.
- [7] T. A. Vakaliuk, O. M. Spirin, N. M. Lobanchykova, L. A. Martseva, I. V. Novitska, V. V. Kontsedailo, Features of distance learning of cloud technologies for the organization educational process in quarantine, *Journal of Physics: Conference Series* 1840 (2021) 012051. doi:10.1088/1742-6596/1840/1/012051.
- [8] S. Sharov, A. Pavlenko, T. Sharova, O. Chorna, Analysis of Developers of Online Courses on Ukrainian Platforms of MOOC, *Int. J. Emerg. Technol. Learn.* (2021) 201–213.
- [9] L. Y. Sultanova, O. P. Tsiuniak, L. O. Milto, M. O. Zheludenko, L. M. Lyktei, L. M. Petrenko, A. D. Uchitel, The potential of Google Classroom web service for lecturers of higher

- educational establishments under pandemic conditions, CEUR Workshop Proceedings 2879 (2020) 346–365. URL: <http://ceur-ws.org/Vol-2879/paper19.pdf>.
- [10] A. F. Tarasov, I. A. Getman, S. S. Turlakova, I. I. Stashkevych, S. M. Kozmenko, Methodical aspects of preparation of educational content on the basis of distance education platforms, CEUR Workshop Proceedings 2643 (2020) 161–173. URL: <http://ceur-ws.org/Vol-2643/paper08.pdf>.
- [11] V. M. Kukhareno, V. V. Bondarenko (Eds.), *Ekstrene dystantsiine navchannia v Ukraini* (Emergency distance learning in Ukraine), Miska drukarnia, Kharkiv, 2020.
- [12] Pro stvorennia Ukrainskoho tsentru dystantsiinoi osvity: nakaz Ministerstva osvity i nauky Ukrainy vid 07.07.2000 No. 293 (On the Establishment of the Ukrainian Centre for Distance Education: Order of the Ministry of Education and Science of Ukraine of 07.07.2000 No. 293), 2000. URL: https://osvita.ua/legislation/Dist_osv/3137/.
- [13] Kontsepsiia rozvytku dystantsiinoi osvity v Ukraini: postanova Ministerstva osvity i nauky Ukrainy vid 20.12.2000 (Concept of Distance Education Development in Ukraine: Decision of the Ministry of Education and Science of Ukraine of 20.12.2000), 2000. URL: <http://www.osvita.org.ua/distance/%20pravo/00.html>.
- [14] Pro zatverdzhennia Polozhennia pro dystantsiine navchannia: nakaz Ministerstva osvity i nauky Ukrainy vid 21.01.2004 No. 40 (On Approval of the Regulation on Distance Learning: Order of the Ministry of Education and Science of Ukraine of 21.01.2004 No. 40), 2004. URL: <https://zakon.rada.gov.ua/laws/show/z0464-04#Text>.
- [15] Pro zatverdzhennia Polozhennia pro dystantsiine navchannia: nakaz Ministerstva osvity i nauky Ukrainy vid 25.04.2013 No. 466 (On Approval of the Regulation on Distance Learning: Order of the Ministry of Education and Science of Ukraine of 25.04.2013 No. 466), 2013. URL: <https://zakon.rada.gov.ua/laws/show/z0703-13#Text>.
- [16] Deiaki pytannia orhanizatsii dystantsiinoho navchannia: nakaz Ministerstva osvity i nauky Ukrainy vid 08.09.2020 roku No. 1115 (Some issues of the organization of distance learning: the decree of the Ministry of Education and Science of Ukraine from 08.09.2020 No. 1115), 2020. URL: <https://zakon.rada.gov.ua/laws/show/z0566-11#Text>.
- [17] I. Mintii, S. Shokaliuk, S. Lytvynova, O. Pinchuk, The design of electronic educational courses on the basis of a typical Moodle course, *Bulletin of Postgraduate education (Educational Sciences Series)* 43 (2020) 66–84.
- [18] S. Kvit, O. Yeremenko (Eds.), *Richnyi zvit Natsionalnoho ahentstva iz zabezpechennia yakosti vyshchoi osvity* (Annual report of the National Agency for Quality Assurance in Higher Education), Natsionalne ahentstvo iz zabezpechennia yakosti vyshchoi osvity, Kyiv, 2021.
- [19] S. Dutta, B. Lanvin, *The Network Readiness Index 2020*, 2020. URL: <https://networkreadinessindex.org/wp-content/uploads/2020/10/NRI-2020-Final-Report-October2020.pdf>.
- [20] A. Syzenko, The Rise of MOOCs: Disrupting Higher Education in Ukraine, in: J. Beseda (Ed.), *DisCo 2016: Towards open education and information society*, Centre for Higher Education Studies, 2016, p. 204–213.
- [21] V. M. Kukhareno, Methodological complex of distance learning, *Information Technologies and Learning Tools* 3 (1). URL: <https://journal.iitta.gov.ua/index.php/itlt/article/view/266>. doi:10.33407/itlt.v3i2.266.

- [22] V. M. Kukharenko, Ekspertyza dystantsiinoho kursu-2021 (Examination of the distance course-2021), 2021. URL: <https://dl.khadi.kharkov.ua/enrol/index.php?id=2194>.
- [23] Intensyvnyi kurs Khmarni tekhnolohii u dystantsiynomu navchanni v umovakh karantynu (Intensive course Cloud technologies in distance learning in quarantine), 2020. URL: <https://news.ztu.edu.ua/2020/03/intensyvnyj-kurs-hmarni-tehnologiyi-u-dystantsijnomu-navchanni-v-umovah-karantynu/>.
- [24] EdEra – studiiia onlain-osvity (EdEra is an online education studio), 2014. URL: <https://www.ed-era.com/>.
- [25] Onlain-kurs dlia vchyteliv ta kerivnykiv shkil pro dystantsiine navchannia (Online course for teachers and school leaders on distance learning), 2020. URL: <https://courses.ed-era.com/courses/course-v1:MON-DECIDE+1+2020/info>.
- [26] Onlain-kurs dlia pedahohiv ta kerivnykiv zakladiv profesiino-tekhnichnoi osvity pro dystantsiine navchannia (Online course for teachers and administrators of vocational education and training institutions on distance learning), 2020. URL: <https://courses.ed-era.com/courses/course-v1:MON-DECIDE+2+2020/info>.
- [27] Bery y roby. Zmishane ta dystantsiine navchannia (Take it and do it. Blended and distance learning), 2021. URL: https://courses.ed-era.com/courses/course-v1:EdEra_Osvitoriya+BR102+2020/about.
- [28] #blend_it: Opanuiemo zmishane navchannia (#blend_it: Mastering blended learning), 2020. URL: <https://courses.ed-era.com/courses/course-v1:DECIDE+3+2020/about>.
- [29] Diia. Tsyfrova osvita (Diia. Digital education), 2021. URL: <https://osvita.diia.gov.ua/>.
- [30] Ohliadovi osvittii serial Karantyn: onlain-servisy dlia vchyteliv (Educational overview series Quarantine: online services for teachers), 2020. URL: <https://osvita.diia.gov.ua/courses/online-services-for-teachers>.
- [31] Tsyfrovi navychky dlia vchyteliv (Digital skills for teachers), 2020. URL: <https://osvita.diia.gov.ua/courses/serial-iz-tsyfrovoi-hramotnosti-dlia-vchyteliv>.
- [32] Interaktyvne navchannia: instrumenty ta tekhnolohii dlia tsikavykh urokiv (Interactive learning: tools and technologies for interesting lessons), 2020. URL: <https://osvita.diia.gov.ua/courses/interactive-learning>.
- [33] Treninh dlia treneriv (Training for coaches), 2020. URL: <https://osvita.diia.gov.ua/courses/training-for-trainers>.
- [34] Distance Learning Courses and Adult Education – The Open University, 1997. URL: <http://www.open.ac.uk/>.
- [35] UNED | Universidad Nacional de Educación a Distancia – Enseñanza Online, 2019. URL: <https://www.uned.es/universidad/inicio.html>.
- [36] Formation tout au long de la vie – Page d'accueil – CNED, 1996. URL: <https://www.cned.fr/>.

The virtual reality simulator development for dental students training: a pilot study

Yulia Yu. Dyulicheva¹, Daniil A. Gaponov¹, Raša Mladenović^{2,3} and Yekaterina A. Kosova¹

¹V. I. Vernadsky Crimean Federal University, 4 Vernadsky Ave., Simferopol, 295007, Crimea

²Faculty of Medicine, Department for Dentistry, University of Pristina, Anri Dinan NN, Kosovska Mitrovica, 38220, Serbia

³Faculty of Medical Science, University of Kragujevac, 68 Svetozara Markovica, Kragujevac, 34000, Serbia

Abstract

The technologies of the augmented and virtual reality have a special role in medical education as an additional tool for training professional skills in pre-clinical practice. In the paper, we describe the development of a virtual reality simulator with immersion in VR scene for dentist office and simulation of tooth drilling. Such kinds of simulators would contribute to evolving capacities of motor skills and hand-eye coordination. The VR simulator for dental students training is developed for Oculus Quest 2 VR headset with six degrees of freedom. The Marching Cubes algorithm is chosen as an optimal decision for autonomous VR headsets, the computational power of which is much lower than PCs. The main stages of the development of tooth drilling simulation are considered. They include voxelization, marching cubes algorithm, collision detection, and detection of penetration depth of the dental drill. The experience of VR scene using for dental students training has been piloted at the Faculty of Dentistry at the V. I. Vernadsky Crimean Federal University. To evaluate the pilot study we used a satisfaction questionnaire, which evaluated the realism of tooth 3D model drilling and the realism of VR scene for the creation of a dentist's office atmosphere.

Keywords

virtual reality simulator, dental education, tooth drilling simulator, VR scene for dentist office

1. Introduction

The augmented and virtual reality are considered as key technologies in education of the 21st century and are used to study complex abstractions [1]. It sounds especially actual as such technologies provided effective tools for the remote students learning in period of pandemic COVID-19.

In recent years, the number of applications based on the augmented and virtual reality for education has increased rapidly. This is due to the capabilities of such technologies to immerse in

AREdu 2021: 4th International Workshop on Augmented Reality in Education, May 11, 2021, Kryvyi Rih, Ukraine

✉ dyulicheva@gmail.com (Y. Yu. Dyulicheva); gaponov.daniil@gmail.com (D. A. Gaponov);

rasa.mladenovic@med.pr.ac.rs (R. Mladenović); kosovakaterina@gmail.com (Y. A. Kosova)

🌐 <https://www.researchgate.net/profile/Yulia-Dyulicheva> (Y. Yu. Dyulicheva);

<https://www.linkedin.com/in/dgaponov> (D. A. Gaponov); <http://www.russiart.info/> (R. Mladenović);

<https://www.researchgate.net/profile/Yekaterina-Kosova> (Y. A. Kosova)

🆔 0000-0003-1314-5367 (Y. Yu. Dyulicheva); 0000-0002-2425-0747 (D. A. Gaponov); 0000-0003-0767-8423

(R. Mladenović); 0000-0002-3263-9373 (Y. A. Kosova)

© 2021 Copyright for this paper by its authors.

Use permitted under Creative Commons License Attribution 4.0 International (CC BY 4.0).

 CEUR Workshop Proceedings (CEUR-WS.org)

a fascinating world and demonstrate non-visible processes and phenomena through the involvement of students in educational process. The teachers can create their own applications with AR/VR thanks to special software such as constructors and visual development environments [2, 3]. It is studied the capabilities of AR/VR portals for training people with disorders to enrich their communication and cognitive skills [4, 5]. The awesome AR/VR simulators and mobile applications were developed for training mathematics [6, 7], physics [8, 9], biology [10, 11], chemistry [12, 13] etc. The search for new educational tools oriented to skills improvement is extremely important. Many investigations in AR/VR field focus on practical skills strengthening through interactions with 3D models, which create illusion of reality.

Medical education is practice-oriented. So, medical education faced the challenge of creating the conditions to acquire the skills of pre-clinical practice with the help of cutting-edge technologies. The technologies of augmented, virtual and mixed realities can be considered as advanced technologies for the creation of effective teaching simulators, but the teacher control on each stage of virtual simulator usage by dental students remains very important with instructions from a teacher about how to use special software for acquiring of manual and technical skills [14].

The rapid development of AR/VR applications in medical education and in medicine, in general, is explained by the emergence of 3D scanners appearance allowed for the creation of fairly accurate and realistic digital models in different applied fields.

The technologies of augmented and virtual reality find more and more usage in the learning of the maxillo-facial and dentistry disciplines on the stage of pre-clinical practice and in real practice, for example, in dental implantology for coupling 3D models with real objects and dynamic navigation [15].

The effectiveness of AR/VR technology in dentistry education is confirmed in many investigations as shown in table 1.

However, the use of virtual reality in predoctoral dental education is still limited [20] and needs to be explored further.

The aim of our research is to develop a virtual reality simulator for the teaching of dental students. The development process for a virtual reality simulator depends on the selected hardware and software. To implement the simulator aimed at dental students teaching, the Oculus Quest 2 VR headset was chosen by authors as the hardware and Unity 3D as the software.

2. Material and methods

2.1. Participants

This study was designed as a pilot study. As a testing result of VR scene usage, we studied the opinions of two experts and three graduate students from the Faculty of Dentistry at the V. I. Vernadsky Crimean Federal University. We used a satisfaction questionnaire, which evaluated the realism of tooth 3D model drilling and the realism of VR scene for the creation of a dentist's office atmosphere (table 2).

Table 1

The effectiveness of AR/VR technology in dental education

Authors of research paper	Field	Technology, hardware/software	Experimental results
Llena et al. [16]	the learning of the cavity preparation design	AR marker recognition technology with 3D cavity models and software apps: Aumentaty Author 1.2+Aumentaty Viewer, Augment app	Results of AR effectiveness are based on questionnaires of 41 students (20 students from AR (experimental) group and 21 students from control group). The results of learning were similar in both groups, but AR group showed better results in the most of skills connected with cavity preparations
Mladenovic et al. [17]	the learning of blockade of the lower alveolar nerve during the anesthesiological procedure	AR marker recognition technology with Dental Simulator app for iOS and Android for local anesthesia implementation in augmented reality mode	Results of AR app effectiveness are based on questionnaires of 21 students. The students after usage of Dental Simulator showed a more quick average time of manipulation, a higher successfulness of anesthesiological procedure doing, and the higher average score of knowledge level
Zafar et al. [18]	the local anaesthetic training in paediatric dentistry	VR simulator implemented for Oculus Quest VR headset with software developed based on Zbrush, Blender, Unity3D, OpenGL	Results of VR simulator effectiveness are based on questionnaires of 71 students. 55 % of recipients confirmed the effectiveness of VR simulator to better understanding of anatomical structure
Zafar and Zachar [19]	head and neck anatomy learning by dental students	mixed reality technology for HoloLens and the usage of software HoloHuman	Results of AR app effectiveness are based on questionnaires of 88 students. 43.5% of participants noted that HoloHuman app improved the understanding of anatomy

2.2. The development of tooth drilling simulation

At the stage of 3D models deformation for simulation of dental operation performance the mathematical and computational methods, image processing, and computer vision methods are used. Kim et al. [21] used a voxel-based collision model and spray effect based on particle systems to simulate tooth restoration and ultrasonic scaling. There are exist many collision detection methods between virtual objects in real time that, in general, are based on intersections of bounding volumes of virtual objects. One of the most popular algorithm for collision detection is Axis-Aligned Bounding Boxes (AABBs) and for improvement of collision performance – hierarchy of R-trees [22], BVH based method for detection of probabilities of interactions [23], apriori algorithm of collision detection [24]. Rhienmora et al. [25] propose to use AABB algorithm for detection of collision between virtual tooth and virtual cylindrical cutting bar.

Wu et al. [26] considered criteria for dental drilling simulation such as fidelity of force, material removal, computational efficiency, and stability. They used voxel-based haptic rendering and real-time visual rendering for the handling of tooth model surface and collision detection with dental drill model.

The approaches to the detection of penetration depth of dental drill have an important role to simulate tooth drilling. Wu et al. [26] considered the sum of resistance forces at all boundary voxels of the drill, drill moving velocity, and material removing velocity. Rhiemora et al. [25] used the proportional dependence of the reaction force and penetration depth of dental drill and proposed force filtering method with possibility of large magnitude control of the force. Zhao et al. [27] proposed to evaluate the penetration force by integrating the unit force acting on the outer voxels of the tool.

For our purpose of tooth drilling simulation we search approach with the following requirements: the algorithm must have a sufficiently high accuracy, which will be close to the capabilities of a real dental drilling; the algorithm would be able to edit meshes with different topologies, including meshes with “holes”, the algorithm has to be optimized for mobile processors and has to be parallel implementation. The last two points are due to the specifics of the platform for which the simulator is being developed: autonomous VR headsets have an integrated mobile processor and a graphics chip, the computational power of which is much lower than PCs. The most suitable algorithm is “Marching Cubes”. Oculus Quest 2 VR headset with six degrees of freedom is optimal decision for the requirements above.

Recently, the Oculus Quest headset is widely used and allows us to immerse in VR environments with high quality in medical education. Meese et al. [28] described the experience of Oculus Quest usage in the cardiopulmonary resuscitation training. Kang et al. [29] developed DeepHandsVR based on a hybrid approach that combined virtual reality with deep learning algorithms to improve interaction in an immersive environment for Oculus Touch and HTC Vive controllers.

The Oculus Quest 2 virtual reality headset and its usage for the development of VR simulator for dentist training is demonstrated in figure 1 (A). For the handling of 3D models of teeth the framework Unity was selected as shown in figure 1 (B).

Before starting to work with the Marching Cubes algorithm, the original 3D model must be voxelized, i.e. convert to scalar density grid. In addition to the density grid, a material map is also needed. It allows, for example, to assign the degree of tooth damage. The material map can also store meta-information about mesh editing under the influence of the drill for further analysis of the simulation results.

For the parallel implementation of the algorithm on the Unity engine, the Job System framework was chosen. This framework allows parallel implementation of many subtasks for a special engine, and the “native” representation of the algorithm for input and output data that is suitable for the chosen architecture. To implement the algorithm, many subtasks were formulated. The first subtask deals with counting mesh density and materials. Each task is responsible for only one vertex of the part of the grid. The second subtask is aimed at the building of a mesh surface on their basis. In order to display the difference between the anatomical structure of tooth and the degree of tooth damage, the subtask aimed at painting of surface polygons with different colors using a palette texture and a uv-map, the positions on which are selected using the material index from the corresponding cell of the material map for the current cube. Another

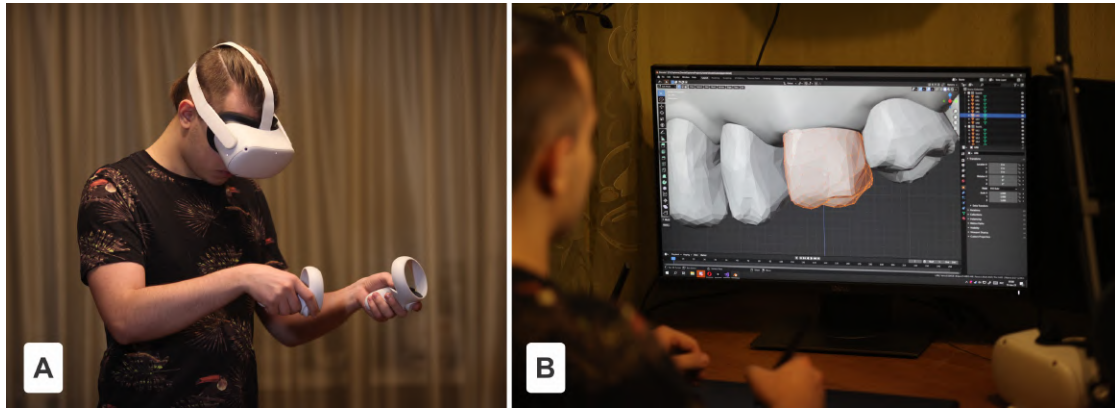

Figure 1: The Oculus Quest 2 headset (A) and Unity framework (B) usage for the development and testing of VR simulator.

subtask solving is aimed at the generation of a set of sub-meshes, which then form the final mesh. Each subtask is responsible for only one cube within its region of interest. The edited surface of the sub-mesh is loaded from the buffer to graphics memory only when all the cubes in the sub-mesh have been processed.

The main stages of tooth drilling simulation development are presented in figure 2. They include voxelization, Marching Cubes algorithm, collision detection, and detection of penetration depth of dental drill as discussed above.

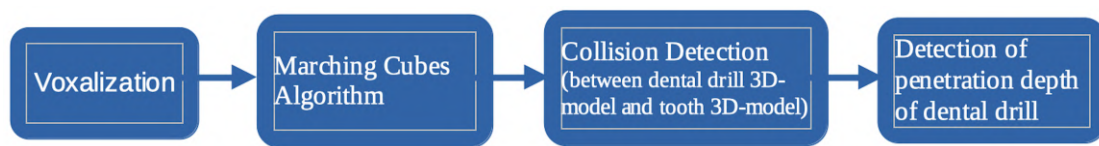

Figure 2: The main stages of the development of a tooth drilling simulation.

The stages of the handling of a tooth 3D model for marching cubes approach are demonstrated in figure 3: from 3D voxelization (to get a set of voxels containing material properties) to handling with marching cubes (tooth surface mesh) and tooth drilling implementation process with the penetration depth control based on force calculation as in [25].

2.3. The development of VR scene for dentist office simulation

For the creation of the realistic immersive virtual environment, the framework Unity XR and single-pass anticipatory rendering engine Universal Render Pipeline were used.

Since the resources of an autonomous VR device are very limited, the 3D models on the scene need to be simplified. For the smoothest display, it is recommended to keep the number of vertices on the scene in a volume of less than 300 000. To do this, you can perform the

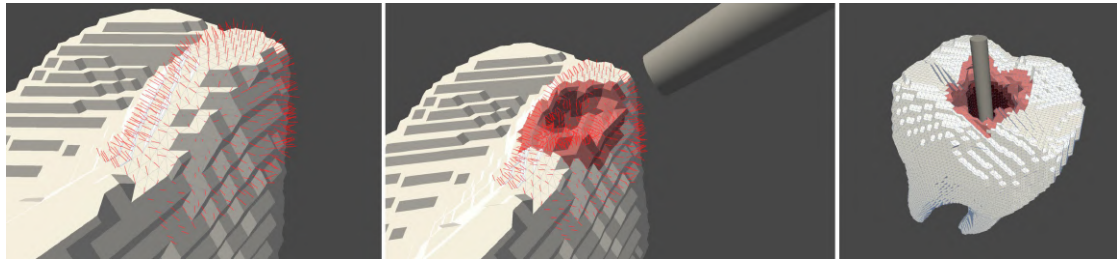

Figure 3: The stages of the tooth handling and the tooth drilling simulation in Unity based on 3D voxelization and marching cubes.

procedure of “decimate” polygons using different algorithms presented in graphic editors. One of the algorithms used from the Blender editor merged polygons if the difference between their normal planes was less than a specified threshold.

Wearing VR headset Oculus Quest 2, the students are transported to a virtual dentist office and can interact with virtual patient’s mouth and dentist’s tools doing a dental procedure with simulation of tooth drilling. The developed VR scene is demonstrated in figure 4.

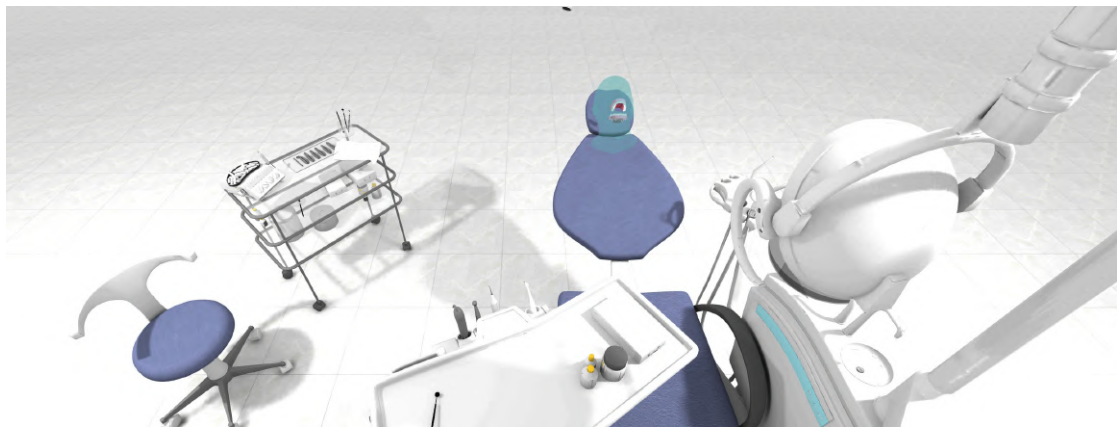

Figure 4: The stages of the tooth handling and the tooth drilling simulation in Unity based on 3D voxelization and marching cubes.

The scene has been designed so that the operator does not have to move around using controllers. All necessary movements can be performed in a real room. Since the headset is autonomous, it does not restrict the operator’s movement and turns, and the sensors have no blind spots. Nevertheless, if the dimensions of the real room do not allow this, the ability to move with the help of controllers is provided. There are interactive instruments on the scene, the main of which is a drill. Taking the drill in hand (bringing the controller to its location on the tools shelf and pressing the pick-up button), you can drill the tooth of the patient, which is located on the dental chair. The keys on the controller allow you to put the drill into working state and change modes. During operation, the controller vibrates at different intensities, creating the

feeling of a real tools. After working with the tool is finished, the operator can return it to the tool shelf.

3. Results

Two experts and three students from the Faculty of Dentistry at the V. I. Vernadsky Crimean Federal University were participated in the testing of pilot version of VR simulator in dental education. They evaluated the realism of the tooth 3D model drilling simulation and the realism of VR scene for dentist's office simulation based on questionnaire demonstrated in table 2. The results of VR environment satisfaction are presented below.

Table 2
Satisfaction questionnaire of VR environment

Questions	Response options
The questions about the realism of the tooth 3D model drilling simulation	
1. Was the tooth 3D model be useful in educational process for you? (only for students)	- yes (the choice of two experts and three students) - no
2. Did you see the tooth 3D model from a different view? (only for students)	-yes (the choice of three students) -no
3. How could you characterize the first experience of tooth drilling simulation? (only for experts)	- useful (the choice of three students) - useless
4. How could you characterize the realism of illusion tooth drilling simulation?	- perfect - acceptable (the choice of two experts) - unsatisfactory
5. Did you need some time for adoption in the VR environment?	- yes (the choice of one expert and two students) - no (the choice of one expert and one student)
The questions about the realism of the VR scene for dentist's office simulation	
1. How could you characterize the realism of VR scene for a dentist's office simulation?	- perfect (the choice of two experts and one student) - acceptable (the choice of two students) - unsatisfactory
2. Did you think that illumination of VR scene was some difference compared with the real dentist's office?	-yes (the choice of two students) -no (the choice of one student)
The common questions about VR simulator	
1. Are this kind of VR simutor useful in dental education?	- yes (the choice of two experts and three students) - no
2. What kind of educational tool could be the VR simulator?	- main - additional (the choice of two experts and three students)
3. Could such VR simulator be useful as a distance learning tool in general and in special conditions (for example, during a pandemic)?	- yes (the choice of two experts and three students) - no

The evaluation of the realism of the tooth 3D model drilling simulation. Two experts noted that 3D model of tooth had acceptable quality, three students noted the usefulness of 3D model

of tooth, possibilities to explore tooth from different views and capacities to get first useful experience of tooth drilling.

The evaluation of the realism of VR scene for dentist's office simulation. Two experts and one student noted that VR scene was enough realistic. Two students noted that they were needed some time to adopt and immerse in virtual environment and noted some differences of illumination compared with the real dentist's office.

All participants noted that such virtual experience was useful as an additional tool to improve quality of education and could be considered as one kind of tool in special condition, but never couldn't replace real practice and could become a powerful competitor for physical templates usage in dental education.

4. Discussion

Technological advances have made it possible to incorporate Virtual Reality simulation technology in dental education, and above all in the preclinical restorative dentistry. Virtual Reality simulators provide the ability to integrate clinical scenarios into the operating environment and facilitate tactile skills using haptic technology [30].

The advantages of 3D digital models' usage in medical education lay in their simplicity of deformation and restoration without worrying that student breaks important sample, for example, plaster jaw model. The augmented or virtual realities create a realistic environment and feel of the realistic first experience of patient treatment. In particular, Procházka et al. [31] study the alternatives for replacing the plaster models of teeth with computer 3D models in AR/VR environments. They consider the problem of the dental orthopantomogram analysis with the usage of edge detection methods and 3D models of dental arches based on image segmentation methods for studying the special region of interest in the arches or teeth.

Training with simulators usage has an important applied role in medical education. In particular, Reznik et al. [32] studied the possibilities of VR simulators usage for first aid training and Pulijala et al. [33] investigated the experience of VR Surgery usage developed for surgical training for Oculus Rift and Leap Motion devices. So, the VR simulators usage can improve fine motor skills and hand-eye coordination when dentists and surgeons teaching in pre-clinical conditions [34]. The virtual reality simulator allows students to immerse in multi-sensory and three-dimensional environment with realistic patient "mannequins" and built-in 3D models of dental instruments as shown in our research. Such simulator acquaints students with the structure of the tooth and gains important clinical competencies in dental surgery.

The main problem is the lack of tactile feedback. So, due to the fact that the operator does not have an emphasis on the real dental chair and the patient's body, the natural shaking of the hands does not allow performing delicate manipulations with the dental drill. Nevertheless, this problem can be solved by resorting to the use of special equipment in the form of a model of a chair and a patient, whose position is synchronized with the position in the simulator and usage of manipulators with tactile feedback instead of ordinary controllers.

Haptic devices create an illusion of "tissues" feeling and interactions with them in the virtual environment and play an important role to form skills in pre-clinical practice. For example, Hung et al. [35] developed the virtual reality training simulator based on a head mount display

and haptic device to practice tooth preparation and noted the perspectives of such decision for training students in a realistic environment with the illusion of realistic dental operations. Anderson et al. [36] studied a haptic-based virtual reality models and their perspectives for dental education, in particular, to enrich practical skills on diagnosis and treatment of periodontal diseases, drilling operations training, head and neck anatomical structure learning.

Besides, AR/VR technologies have proved successful to prevent anxiety for people with different phobia and also during dental treatment [37], especially for children. The first negative experience of children teeth treatment may form a stable sense of fear and anxiety before each visit to the dentist and even further in adulthood. The usage of eyeglasses reduces stress level during teeth treatment confirmed by some vital signs as pulses and blood pressure [38]. The gamification approach with AR/VR is also produces significant results to decrease anxiety when virtual heroes immerse children in the atmosphere of teeth treatment and explain the necessity of dental manipulations [39].

5. Conclusion

The Oculus Quest 2 Virtual Reality dental training simulator is capable of simulating the visual experience in the simulation process. Further improvement of this simulator will be aimed at recreating tactile sensations and feedback. The VR simulator can be used in the educational process by dental students at the stage of acquiring primary skills in tooth drilling with immersion in the virtual environment.

Testing of the VR simulator on the pilot study has shown promising results in the field of practical skills improvements on the training of the dental students in pre-clinical conditions.

Acknowledgments

Thanks to the experts and students from the Faculty of Dentistry at V. I. Vernadsky Crimean Federal University that were participated in a pilot study of VR simulator testing in dental education.

References

- [1] G. Molnar, Z. Szuts, K. Biro, Use of augmented reality in learning, *Acta Polytechnica Hungarica* 15 (2018) 209–222. URL: http://acta.uni-obuda.hu/Molnar_Szucs_Biro_84.pdf.
- [2] Y. Dyulicheva, The use of augmented reality technology to improve the efficiency of teaching, *Informatics in School* 3 (2020) 37–46. doi:10.32517/2221-1993-2020-19-3-37-46.
- [3] S. Zelinska, A. Azaryan, V. Azaryan, Investigation of opportunities of the practical application of the augmented reality technologies in the information and educative environment for mining engineers training in the higher education establishment, *CEUR Workshop Proceedings* 2257 (2018) 204–214.
- [4] Y. Dyulicheva, Y. Kosova, A. Uchitel, The augmented reality portal and hints usage for assisting individuals with autism spectrum disorder, anxiety and cognitive disorders, *CEUR Workshop Proceedings* 2731 (2020) 251–262.

- [5] J. Quintero, S. Baldiris, R. Rubira, J. Cerón, G. Velez, Augmented reality in educational inclusion. a systematic review on the last decade, *Frontiers in Psychology* 10 (2019) 1835. URL: <https://www.frontiersin.org/article/10.3389/fpsyg.2019.01835>. doi:10.3389/fpsyg.2019.01835.
- [6] I. Guntur, W. Setyaningrum, The effectiveness of augmented reality in learning vector to improve students' spatial and problem-solving skills, *International Journal of Interactive Mobile Technologies* 15 (2021). doi:10.3991/ijim.v15i05.19037.
- [7] T. Kramarenko, O. Pylypenko, V. Zaselskiy, Prospects of using the augmented reality application in STEM-based Mathematics teaching, *CEUR Workshop Proceedings* 2547 (2020) 130–144.
- [8] N.-J. Sung, J. Ma, Y.-J. Choi, M. Hong, Real-time augmented reality physics simulator for education, *Applied Sciences* 9 (2019). URL: <https://www.mdpi.com/2076-3417/9/19/4019>. doi:10.3390/app9194019.
- [9] A. E. Kiv, V. V. Bilous, D. M. Bodnenko, D. V. Horbatovskiy, O. S. Lytvyn, V. V. Proshkin, The development and use of mobile app ar physics in physics teaching at the university, *CEUR Workshop Proceedings* (2021).
- [10] N. K. Cakir, G. Guven, C. Celik, Integration of mobile augmented reality (MAR) applications into the 5E learning model in biology teaching, *International Journal of Technology in Education* 4 (2021) 93–112. doi:10.46328/ijte.82.
- [11] L. Y. Midak, I. V. Kravets, O. V. Kuzyshyn, L. V. Baziuk, K. V. Buzhdyhan, J. D. Pahomov, Augmented reality as a part of STEM lessons, *Journal of Physics: Conference Series* 1946 (2021) 012009. doi:10.1088/1742-6596/1946/1/012009.
- [12] S. Cai, X. Wang, F.-K. Chiang, A case study of augmented reality simulation system application in a chemistry course, *Computers in Human Behavior* 37 (2014) 31–40. doi:10.1016/j.chb.2014.04.018.
- [13] P. Nechypurenko, V. Stoliarenko, T. Starova, T. Selivanova, O. Markova, Y. Modlo, E. Shmeltser, Development and implementation of educational resources in chemistry with elements of augmented reality, *CEUR Workshop Proceedings* 2547 (2020) 156–167.
- [14] T.-Y. Chang, G. Hong, C. Paganelli, P. Phantumvanit, W.-J. Chang, Y.-S. Shieh, M.-L. Hsu, Innovation of dental education during covid-19 pandemic, *Journal of Dental Sciences* 16 (2021) 15–20. doi:10.1016/j.jds.2020.07.011.
- [15] G. Pellegrino, C. Mangano, R. Mangano, A. Ferri, V. Taraschi, C. Marchetti, Augmented reality for dental implantology: a pilot clinical report of two cases, *BMC Oral Health* 19 (2019) 158. doi:10.1186/s12903-019-0853-y.
- [16] C. Llana, S. Folguera, L. Forner, F. J. Rodríguez-Lozano, Implementation of augmented reality in operative dentistry learning, *European Journal of Dental Education* 22 (2018) e122–e130. doi:10.1111/eje.12269.
- [17] R. Mladenovic, D. Dakovic, L. Pereira, V. Matvijenko, K. Mladenovic, Effect of augmented reality simulation on administration of local anaesthesia in paediatric patients, *European Journal of Dental Education* 24 (2020) 507–512. doi:10.1111/eje.12529.
- [18] S. Zafar, A. Siddiqi, M. Yasir, J. J. Zachar, Pedagogical development in local anaesthetic training in paediatric dentistry using virtual reality simulator, *European Archives of Paediatric Dentistry* (2021). doi:10.1007/s40368-021-00604-7.
- [19] S. Zafar, J. J. Zachar, Evaluation of HoloHuman augmented reality application as a novel

- educational tool in dentistry, *European Journal of Dental Education* 24 (2020) 259–265. doi:10.1111/eje.12492.
- [20] A. Liebermann, K. Erdelt, Virtual education: Dental morphologies in a virtual teaching environment, *Journal of Dental Education* 84 (2020) 1143–1150. doi:10.1002/jdd.12235.
- [21] K. Kim, J. Cho, J. Kim, J. Park, A dental simulator for training of prevalent interventions: Tooth restoration and ultrasonic scaling, in: P. Isokoski, J. Springare (Eds.), *Haptics: Perception, Devices, Mobility, and Communication*, Springer Berlin Heidelberg, Berlin, Heidelberg, 2012, pp. 195–198.
- [22] M. Figueiredo, Surface collision detection for virtual prototyping, in: Y. Xiao, T. Amon, P. Kommers (Eds.), *IADIS International Conference Computer Graphics, Visualization, Computer Vision and Image Processing*, 2009, pp. 65–72. URL: <http://www.iadisportal.org/digital-library/surface-collision-detection-for-virtual-prototyping>.
- [23] G. Zachmann, *Virtual Technologies for Business and Industrial Applications: Innovative and Synergistic Approaches*, IGI Global, 2011, p. 32. doi:10.4018/978-1-61520-631-5.ch003.
- [24] I. Alaytsev, T. Danilova, A. Manturov, G. Mareev, O. Mareev, A priori collision detection algorithm for 3-DOF haptic rendering, *International Research Journal* 12 (2016) 47–50. doi:10.18454/IRJ.2016.54.180.
- [25] P. Rhienmora, P. Haddawy, M. Dailey, P. Khanal, S. Suebnukarn, Development of a dental skills training simulator using virtual reality and haptic device, *NECTEC Technical Journal* 8 (2008). URL: <https://www.cs.ait.ac.th/~mdailey/papers/Rhienmora-ToothHaptics.pdf>.
- [26] J. Wu, G. Yu, D. Wang, Y. Zhang, C. C. L. Wang, Voxel-Based Interactive Haptic Simulation of Dental Drilling, volume 2: 29th Computers and Information in Engineering Conference, Parts A and B of *International Design Engineering Technical Conferences and Computers and Information in Engineering Conference*, 2009, pp. 39–48. doi:10.1115/DETC2009-86661.
- [27] X. Zhao, Z. Zhu, Y. Cong, Y. Zhao, Y. Zhang, D. Wang, Haptic rendering of diverse tool-tissue contact constraints during dental implantation procedures, *Frontiers in Robotics and AI* 7 (2020) 35. URL: <https://www.frontiersin.org/article/10.3389/frobt.2020.00035>. doi:10.3389/frobt.2020.00035.
- [28] M. M. Meese, Z. Trost, T. P. Chang, Immersive virtual reality anesthesiology training: The next frontier in simulation training, *Journal of Clinical Anesthesia and Pain Management* 4 (2020). doi:10.36959/377/337.
- [29] T. Kang, M. Chae, E. Seo, M. Kim, J. Kim, DeepHandsVR: Hand interface using deep learning in immersive virtual reality, *Electronics* 9 (2020). URL: <https://www.mdpi.com/2079-9292/9/11/1863>. doi:10.3390/electronics9111863.
- [30] R. Mladenovic, D. Dakovic, K. Mladenovic, Development of simulation methods in biomedical sciences - from phantoms to virtual patients, *Serbian Journal of Experimental and Clinical Research* (2020). doi:doi:10.2478/sjecr-2020-0051.
- [31] A. Procházka, T. Dostálová, M. Kašparová, O. Vyšata, H. Charvátová, S. Sanei, V. Mařík, Augmented reality implementations in stomatology, *Applied Sciences* 9 (2019). URL: <https://www.mdpi.com/2076-3417/9/14/2929>. doi:10.3390/app9142929.
- [32] E. Reznik, I. Krasnopolskij, M. Potemkina, O. Prirodova, Using virtual reality technologies to practice the algorithm of emergency medical care, *Methodology and Technology of Continuing Professional Education* 2 (2020) 6–14.

- [33] Y. Pulijala, M. Ma, M. Pears, D. Peebles, A. Ayoub, Effectiveness of immersive virtual reality in surgical training – a randomized control trial, *Journal of Oral and Maxillofacial Surgery* 76 (2018) 1065–1072. doi:10.1016/j.joms.2017.10.002.
- [34] E. Roy, M. Bark, R. George, The need for virtual reality simulators in dental education: A review, *The Saudi Dental Journal* 29 (2017) 41–47. doi:10.1016/j.sdentj.2017.02.001.
- [35] H. Hung, H. Kim, S. Moon, Virtual reality training simulator for tooth preparation techniques, *Oral Biology Research* 42 (2018) 235–240. doi:10.21851/obr.42.04.201812.235.
- [36] P. Anderson, M. Ma, M. Poyade, *A Haptic-Based Virtual Reality Head and Neck Model for Dental Education*, Springer Berlin Heidelberg, Berlin, Heidelberg, 2014, pp. 29–50. doi:10.1007/978-3-642-54816-1_3.
- [37] R. Mladenovic, F. Djordjevic, Effectiveness of virtual reality as a distraction on anxiety and pain during impacted mandibular third molar surgery under local anesthesia, *Journal of Stomatology, Oral and Maxillofacial Surgery* (2021). doi:10.1016/j.jormas.2021.03.009.
- [38] E. Birang, J. Yaghini, R. Birang, M. Zohary, Effect of virtual reality during periodontal treatment of patients with anxiety, *Journal of Research in Dental and Maxillofacial Sciences* 4 (2019). URL: <http://jrdms.dentaliau.ac.ir/article-1-225-en.html>. doi:10.29252/jrdms.4.1.9.
- [39] K. E. Jones, F. Loizides, P. Eslambolchilar, I. Johnson, S. Bhatia, O. Crawford, M. Beirne, R. Chand, L. Vuilleumier, I. Araneta, Reducing anxiety for dental visits, in: D. Lamas, F. Loizides, L. Nacke, H. Petrie, M. Winckler, P. Zaphiris (Eds.), *Human-Computer Interaction – INTERACT 2019*, Springer International Publishing, Cham, 2019, pp. 659–663.

Application of VR technologies in building future maritime specialists' professional competences

Serhii A. Voloshynov¹, Felix M. Zhuravlev², Ivan M. Riabukha¹, Vitaliy V. Smolets³ and Halyna V. Popova¹

¹*Kherson State Maritime Academy, 20 Ushakova Ave., Kherson, 73000, Ukraine*

²*State University of Economics and Technology, 5 Stepana Tilhy Str., Kryvyi Rih, 50006, Ukraine*

³*National University "Odessa Maritime Academy", 8 Didrikhson Str., Odessa, 65029, Ukraine*

Abstract

Progress of modern digital technologies enlarged the quantity of researches about implementation and usage of VR technologies in education process of higher educational establishments. The article provides analysis of best practices of simulation technologies application in maritime education. Absence of national research experience, evidence base for efficiency of new VR simulators operation leaves this issue open to be investigated in terms of researches on their performance effectiveness. The article proposes overview of advantages of VR technologies implementation aimed at building and shaping of future maritime specialists' professional competences. Authors investigate potential application possibilities of interactive and representative potential of immersion digital technologies during education process at maritime educational establishments. Problem of VR technologies integration into education and training of future seafarers is highlighted, as well as possibility to use virtual courses in the process of future maritime specialists' training. The article reveals prognostic validity of VR simulators used for building of professional competences.

Keywords

virtual reality, professional competences, maritime specialists, validity of simulator

1. Introduction

Development of innovation technologies in maritime industry and seamanship, acceleration of life pace, increase in knowledge volume, and introduction of new educational methods make modern maritime education system develop new approaches to future maritime specialists' training. Modification of maritime education according to international standards allows Ukrainian maritime specialists to be successful and competitive at world labour market.

As a rule, training of seafarers presupposes acquisition of practical skills directly onboard the vessel; it inevitably leads to risks of complications of both material and human factor. Therefore, International Maritime Organisation (IMO) made provisions for necessity of simulator-based

AREdu 2021: 4th International Workshop on Augmented Reality in Education, May 11, 2021, Kryvyi Rih, Ukraine

✉ vitaliy@oms-vr.com (V. V. Smolets); spagalina@gmail.com (H. V. Popova)

🌐 <http://new.ksma.ks.ua/?p=3339> (S. A. Voloshynov);

<https://www.ozon.ru/person/zhuravlev-feliks-mihaylovich-84143643/> (F. M. Zhuravlev);

<http://new.ksma.ks.ua/?p=3633> (I. M. Riabukha); <http://new.ksma.ks.ua/?p=3361> (H. V. Popova)

🆔 0000-0001-7436-514X (S. A. Voloshynov); 0000-0002-6217-1177 (I. M. Riabukha); 0000-0002-2805-0021

(V. V. Smolets); 0000-0002-6402-6475 (H. V. Popova)

© 2021 Copyright for this paper by its authors.
Use permitted under Creative Commons License Attribution 4.0 International (CC BY 4.0).



CEUR Workshop Proceedings (CEUR-WS.org)

training in the process of future maritime professionals' education. This requirement is stated in STCW Convention; and the Convention is obligatory to be followed by educational establishments in order to achieve the prescribed competence standard of maritime professionals [1].

Simulators of vehicles used nowadays (cars, lorries, tanks, air and space crafts) are commercially available and effective in the process of education and training [2, 3, 4, 5, 6, 7].

Simulator-based training is one of the basic methods for practical training of maritime specialists in developed countries [8].

Virtual reality technology (VR) creates simulated educational and training environment, and VR trainings allow students to shape their professional competences comprehensively and systematically [9, 10, 11, 12].

Modern hi-tech ship equipment requires specialized education and training with implementation of phantoms, replicas, simulators and simulation installations.

As international experience proves, process of education and training of future maritime professionals should be supplemented with the stage of simulator-based training.

Among the factors promoting development of simulator-based training we can find competence-based approach in education [13, 14, 15, 16, 17, 18, 19, 20, 21, 22, 23, 24, 25, 26, 27, 28] and change of education paradigm aiming at dual [29, 30] and life-long education [31], introduction of blended learning [32, 33, 34, 35, 36].

Implementation and improvement of modern methods of professional competence building is objectively increasing demand for professionals able to use hi-tech digital equipment.

The simulator OMS-VR, proposed to the Academy for testing and approbation, became an inducement for this research. Operating out of Odessa, OMS-VR has developed a series of virtual reality based simulations covering activities that are difficult or dangerous to train in the real world. Their training library includes titles covering proficiency in survival craft and fast rescue boats, tanker cargo operations, steering gear maintenance, launching distress flares, and ballast tank inspections [37].

Besides, another inducement for research is absence of available and effective homemade simulators. It reveals the absence of methodology basis for introduction of simulators into the process of professional competences building.

Relevance of simulator-based technologies for maritime education as field of scientific knowledge and practical specialty is beyond question. At the same time, it is necessary to define actual problems of professional competences building in those areas, where implementation of simulator-based technologies is regarded to be particularly useful and will be of great importance for further development.

2. Theoretical background

Nowadays scientific community is engaged with idea of necessity of new information technologies implementation into educational process; but absence of research experience, lack of evidence base connected with efficiency of new simulators' operation leaves much to be done on investigation of these technologies performance efficiency. Due to high initial cost of equipment and software development VR technologies are slowly adopted and implemented

into educational process of educational establishments of Ukraine.

Emergence and development of simulators is connected with situation simulation for military servants aimed at creation of safe training environment and it proved to be highly efficient. VR technologies then were adopted in sports [38], industry, medicine etc. It is surgery now, that is regarded to be promising direction for scientific and applied researches in the field of simulator-based training technologies [39, 40]. Korniienko and Barchi [40] states that usage of traditional education methods containing static text and illustrations is not sufficient to understand all processes in anatomy. On the other hand implementation of VR technologies allows to improve comprehension, enhance motivation and engagement of students, accelerate process of education and achieve the effect of “learning by doing”. Combination of visual, audial and kinesthetic content in realistic virtual scenario is a new concept of education, which has great potential for development.

Analysis of research works on VR technologies proves their quick pace of development and further great opportunities for implementation [41, 42, 43].

Majority of scientists agree with the idea that implementation of these technologies into education process at all the stages requires much research to be done: starting from the strategy of education process modelling and its key factors and specifically up to process of evaluation and assessment of these technologies efficiency in the framework of professional competences building [38, 44, 45, 46, 47].

Radianti et al. [48] emphasizes the necessity and importance of the factor that development of strategy of VR technologies implementation into education process should be based on the existing education theories. It is connected with development and elaboration of aims of education, key motivational principles for education process and learning outcomes for every theory of education.

Quite comprehensive review of VR technologies [44, 45, 48] proves that virtual reality tools are aimed at practical skills development facilitating understanding of complex concepts for students through simulation of real situations. Diversified interactivity and flexibility is regarded to be standard for VR development platforms [41].

Majority of researchers investigating VR technologies point out further effects for education process:

1. Cost effectiveness (high accuracy of education, small amount of time, great level of virtualization and understanding, decrease of expenses for real equipment for education);
2. Transfer of behavior skills attained in VR environment into real world;
3. Potential for enhancement of learning skills in safe environment [41, 49, 50].

Effects of immersion and participation are regarded to be main advantage of VR; they enhance pace of learning. Lieze et al. [43] states that the wider sense of participation and witness, the more meaningfully VR environment is perceived. Checa and Bustillo [44] describes participation as technological matching with reality, which can be objectively evaluated. The authors proposes to engage this factor as an evaluation criteria for educational VR technologies.

Simulator-based technologies are being successfully integrated into maritime education. Simulators of ship bridge and engine room are being widely used [8, 49, 50, 51, 52, 53, 54, 55, 56].

Nowadays simulators of ship bridge and engine room have become standard and commonplace utilities for seafarers' professional competences building (TRANSAS, SEAGULL), and VR

simulators are in the process of introduction and implementation into training practice [57, 58].

In May 2017, Winterthur Gas & Diesel installed its W-Xpert Full Mission Simulator for training complete engine room crews, at the Marine Power Academy Training Centre of HHM, in Shanghai, China while DNV GL held its traditional press conference at the Nor-Shipping trade fair showcasing the company's innovative vision, with attendees taking part in a virtual reality presentation [59].

Another example is company Khora, which helped the Knowledge Center to build a VR training simulation that enables students to practice dangerous work tasks in a virtual environment, recreating a situation that are hard to simulate in real life [60].

XVR Simulation in partnership with Falck Safety Services and Sapphire Complete developed safety techniques in shipping enabling introduction of new training methods like virtual reality and web-based learning, as well as elaborated a concept of hybrid education. The developers combined realistic learning and simulation in virtual reality and thus reduced length of the course from seven days of traditional classroom training to four-five days of interactive, scenario based training [58].

As one of the leading suppliers of offshore gangways, Uptime International now uses VR simulators to reduce training costs for its customers [59].

Sendi [54] points out that simulation is a key strategy for improvement of all aspects related to and regulating safety at sea.

Asghar Ali Latin generates 16 advantages of maritime education and training using simulation technologies; among them: possibility to utilize different vessel types in one simulator, non-requirements for fuel and time limits during training, independence from time and space, weather conditions management, possibility to create different scenarios in order to shape definite competences [57].

Researchers of maritime education and training note that simulators are essential in learning process of future seafarers in order to create difficult environment and stressful situations aiming at prevention of unpredictable behavior in real life; they state that simulation can shorten length of a course from one year to several weeks [52, 53, 56].

Simulator-based training (SBT) allows to conduct practical training, relapsing high-risk operations to achieve automaticity of skills and operation; in such mode instructor (teacher) can let cadets make mistakes in some limits in order to visualize the consequences and to shape preventive mechanisms for such mistakes in real professional activity [52].

It is considered that SBT promotes development of professional thinking of future maritime specialists, ability to make decisions, their self-confidence through engagement of emotional state during executing interactive exercises [61, 62]. And combination of digital education technologies with gamification is regarded to be institutional tool having higher efficiency comparing to traditional mode of education [63].

Lindmark [55] points out that aims of learning in maritime education (Bloom's Taxonomy) are closely connected to the aims of STCW Code: knowledge, comprehension (understanding) and application (skills). Therefore, if first two units can be evaluated with the help of test tasks, the best way to evaluate professional competence is practical examination with the help of a simulator. Researchers state that the best option is automatic evaluation of student's actions by a simulator, having strict and clear standards and evaluation criteria described in regulatory documents [54, 55].

Before implementing simulator into maritime specialists' education and training process, it should be tested for validity issues. After analysis and introduction of new simulation VR technologies into education process, we propose to elaborate the idea of integration of VR technologies in education and possibility to apply virtual study courses in the process of future maritime specialists' education and training according to predictive validity of a simulator.

3. Results

Requirements to the process of future maritime specialists' training are outlined in the framework of international regulatory acts (prevailing over the national ones), namely STCW Convention, IMO Model Courses directing maritime educational establishments to implement and apply actively in their education and training process distant and digital technologies, e-learning procedures, as well as simulation equipment and installations.

Chapter A I/12 of STCW Convention outlines two standards of productivity: one of them is applied to simulator utilized in education and training process, the other one – to simulator utilized for competence evaluation needs.

For obtaining sailor's Certificate of Competence, obligatory to work onboard, it should be proved that the candidate meets the requirements of competences level defined for the positions, functions and levels of Chapter A II/1-7 of STCW. This fact proves that modern education and training of future maritime specialists is based on competency-based approach. The abovementioned requirement is outlined in Bachelor's Level Standard [64].

One of the ways to achieve the aim is cooperation of educational institutions with companies specializing in software development for professional education. Example of such cooperation in development of e-learning and providing cloud services is collaboration of Kherson State Maritime Academy with OMS-VR Company (Odesa, Ukraine), developers of modern software actively working in the field of training and requalification of maritime specialists.

The Company has developed a set of courses (simulating ones) based on virtual reality engaging professional situations onboard, which are difficult to be trained using traditional education methods.

The Ukrainian startup is certified by Bureau Veritas and is already working with fleet management companies including Wallem, Anglo-Eastern, and Star Bulk.

Developers introduce AR/VR based training equipment and develop their own environmental math model as new Tool in MET, which allows to simulate familiarisation and accident learning cases. This kind of training involves students to accident environments with all the adrenaline shocking, visual, sound, vibra and gravity feeling. It leads to much deeper learning and incomparably more reliable exam results [37].

OMS-VR allows simultaneous connection of great number of VR stations using cloud technologies and their operation in multiuser mode (figure 1).

Application of simulator-based learning allows creation of problem-based education process, where solvation of definite situation becomes an educational task (exercise). Course of simulator-based learning is a scheduled outline of education containing aims and tasks of educational and training activity, their sequence and evaluation of performance [65].

Complex of software elements was created for education and automated check and evaluation

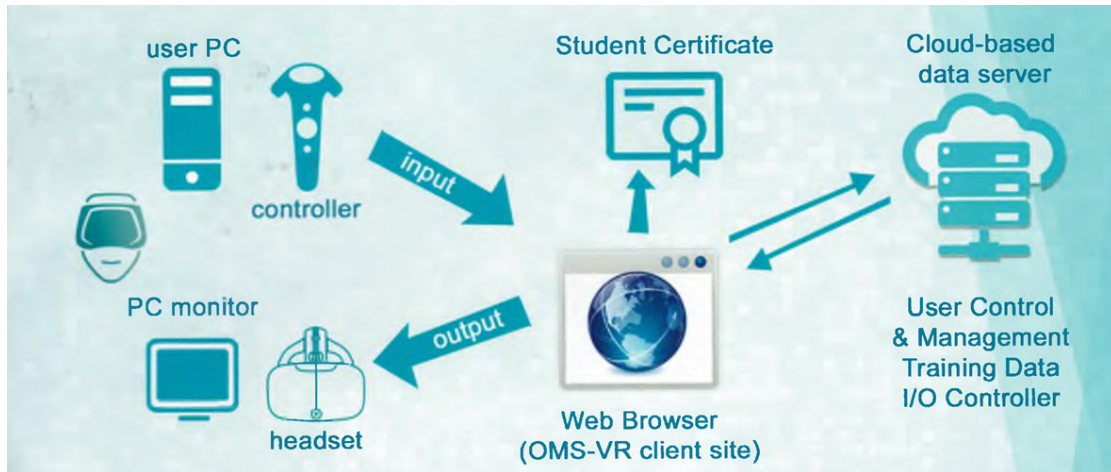

Figure 1: Layout of VR Simulator operation.

of maritime professionals' knowledge and skills; their correspondence to international and home requirements. The created virtual reality is an interactive environment – actions of user cause changes, the screen depicts movements and operations with tools. Accordingly, VR system allows simultaneous imitation of visual, tactile and audial images enhancing reality environment effect.

All virtual learning courses are launched from web-server. Information and statistical data about students' participation and performance are collected in the server in order to generate course certificates.

To start the course corresponding plugin should be launched and amended reality glasses should be worn. Learning is done individually through immersion into professional situation. Teacher has possibility to watch and monitor student's performance, because all his actions are shown on the screen.

High level of realism is less important in the course than achievement of the set tasks aimed at professional competence building. Therefore, all virtual courses are developed according to regulatory requirements and clearly describe anticipated competences to be built at the end of the course table 1.

Every course contains training package and package for evaluation, including critical and emergency situations.

Aiming at facilitation, all actions of training package are supported with visual prompts, animation, digital and graphical elements (green in colour – figure 2). Learning and training is done according to algorithm defined in corresponding regulatory document of every course. Every stage of the course clearly demonstrates sequence of actions (accompanied by visual and audial prompts) that should be followed and done in order to perform process operation.

In the evaluation mode Report File is automatically generated after performance of definite cycle of actions for completing the task. This file contains information on objective parameters of task performance, time laps and evaluation of separate stages of process operation (figure 3).

Table 1
Virtual learning courses

Nº	Name	Regulating documents	Correspondence to STCW	Description of professional competences of the course
1	Training Crewmembers for Ship Helicopter Operations	Solas Convention SIRE VIQ ICS GUIDE TO Ship Helicopter Operation	Table V1-1-1	Theoretical knowledge and practical skills for crewmembers in order to participate in merchant ship helicopter operations
2	Bulker Crane Operator	Lifting Plant and operations (COSWP), MSA CSS	Table A-V1-1-1	Theoretical knowledge and practical skills for crewmembers in order to operate bulker lifting plant safely
3	Chemical Tanker Wall Wash	IMO model course 1.03	Table A-V1-1-3	Theoretical knowledge and practical skills for crewmembers in order to comply with the requirements and procedures of Wall Wash Standard

In order to be integrated new simulation technology, as any other educational technology, has to be validated. Validation – evidence of efficiency and accuracy of education and evaluation function of a technology. If we take simulation validity, it is understood as ability to ensure higher cognitive, emotional and psychomotor skills at anticipated level with the help of achieved degree of realism [65].

To identify demonstrable and content validity we used questionnaire method in three groups of experts (experienced maritime specialists, teachers-instructors, students with induction onboard experience). Questionnaire blank contained questions developed with the help of Likert scale, which ensures relative reliability with limited number of judgements.

The results of the questionnaire revealed that no one of experts has experienced simulation learning before (100 % of respondents answered negatively). It proves the fact that there are no available VR simulators in Ukraine and, as a consequence, it proves novelty of this direction in maritime education and training.

Questions were related to virtual course Life-Boat Launching; all the experts participated in this course table 2.

There were chosen two groups of students (15 persons each). Pearson’s criterion was used to prove absence of statistic deviations between control and experimental groups.

Prognostic validity defines that skills acquired during simulated training reflect the level of professional competence building in real-life environment. In order to estimate prognostic validity there was held comparison of learning outcomes of experimental group of students (virtual reality) and control group of students (KSMA Training Center). The Certificate Course “Certificate of proficiency in survival craft and rescue boats other than fast rescue boats” of Training Center has duration of 30 hours.

Control group studied theoretical module of the course using standard methodic, defined in IMO Model Course. Students of this group had two days of traditional education process in classroom with instructor in order to master theory. Students of experimental group mastered

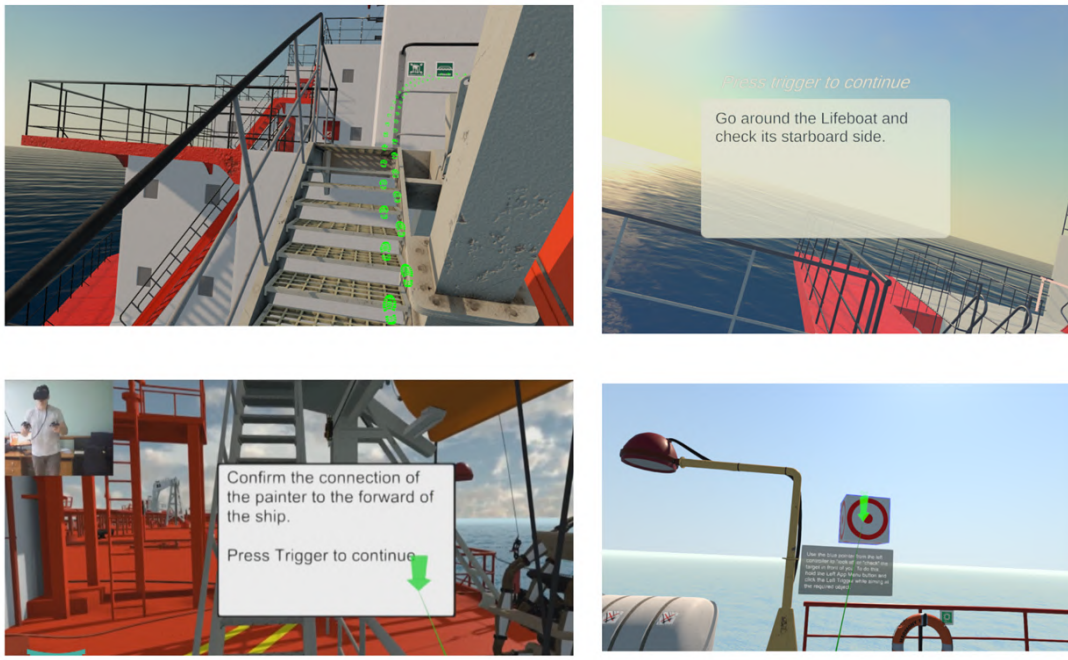

Figure 2: Examples of virtual courses.

↳ Lesson: EPIRB and SART Assessment

not completed

Failed - version:2019v1		Jan 27, 2021, 1:59:52 PM	
Date: Wednesday, January 27, 2021 at 1:59:52 PM GMT+02:00			
Center: KMSTC			
Total Score: 60			
Time: 7 Minutes			
Performance	Status	Information - Answer	Score
Emergency Position Indicating Radio Beacon was activated correctly.	Passed		40
Emergency Position Indicating Radio Beacon was mounted correctly.	Passed		10
Search And Rescue Transponder wasn't activated correctly.	Failed		0
Search And Rescue Transponder was mounted outside the survival craft.	Passed		5
Search And Rescue Transponder was mounted to the highest point above the survival craft.	Passed		5

Figure 3: Check-list of the course.

theoretical module using VR simulator during one day. The last day of the course was devoted to training and evaluation of the acquired professional competence using real simulator “Free-Fall Lifeboat” at Water Station of KSMA.

As a result, both groups answered test questions. Assessment had 100 points scale, where 70 points is PASSED to be certified. Average point of control group was 85.09, experimental group

Table 2

Results of questionnaire on quality of training using VR simulator, %

	Cap- tains	Students with onboard experience
How realistic is the model of the course comparing to real onboard situation?	90	78
What is the degree of correspondence of actions in VR to actions onboard real vessel?	95	91
Do you think your actions would be better if they were structurally evaluated?	100	87
Is it appropriate to introduce virtual course into education process?	98	92

– 86.63. The results (check-lists) are given in the table 3.

Table 3

Results of check-list analysis

Practical Demonstration	Control group	Experi- mental group
The Free-fall Lifeboat was launched.	82	87
The charging cable was detached.	80	89
The charging socket was sealed with a waterproof plug.	85	87
The boarding door was fully closed during the launch.	84	92
The drain plug was sealed.	81	85
Not all valves on the air cylinders were opened.	88	83
The air supply system was activated.	85	81
The engine was running at the time of the launch.	88	92
The seat belt was worn at the time of the launch.	87	85
The Free-fall Lifeboat wasn't sailing astern after the launch.	90	91
The lights were on.	86	81
Average	85.09	86.63

Thus, control group spent three days for the course and experimental group spent two days having at the end equally high indices of acquired competence quality.

4. Conclusion

Summing up the experiment, we can state that the learning outcomes of students being trained with VR simulators do not deviate from those being taught with traditional methods. According to prognostic validity, we can prove that students of experimental group will demonstrate the level of professional competence building at the same rate when being onboard during professional routine operations. These results are provisional ones; they reveal possibility to implement VR simulation for experimental psychological and pedagogical investigations.

At the same time, they prove actuality of joint work of software developers and teachers-guidance counsellors. This work is very important for integration of two professional groups of researchers aiming at development of unified theoretical and methodical basis for providing possibility of simulators introduction into education process, development of joint terminology basis and accumulation of methodological grounding for VR simulators operation.

Taking into account the advantages of virtual reality technologies and their usage in education as well as new possibilities of digital technologies, we deem it necessary to develop these technologies in maritime education aiming at high quality building of professional competences of future maritime professionals.

References

- [1] International Convention on Standards of Training, Certification and Watchkeeping for Seafarers (including 2010 Manila Amendment), INTERNATIONAL MARITIME ORGANIZATION, London, 2017.
- [2] Home, 2021. URL: <https://vrm.space/>.
- [3] P. Nechypurenko, T. Starova, T. Selivanova, A. Tomilina, A. Uchitel, Use of augmented reality in chemistry education, CEUR Workshop Proceedings 2257 (2018) 15–23.
- [4] A. Kiv, O. Merzlykin, Y. Modlo, P. Nechypurenko, I. Topolova, The overview of software for computer simulations in profile physics learning, CEUR Workshop Proceedings 2433 (2019) 352–362.
- [5] O. Lavrentieva, I. Arkhypov, O. Kuchma, A. Uchitel, Use of simulators together with virtual and augmented reality in the system of welders' vocational training: Past, present, and future, CEUR Workshop Proceedings 2547 (2020) 201–216.
- [6] T. Vakaliuk, V. Kontsedailo, D. Antoniuk, O. Korotun, I. Mintii, A. Pikilnyak, Using game simulator Software Inc in the Software Engineering education, CEUR Workshop Proceedings 2547 (2020) 66–80.
- [7] T. Vakaliuk, V. Kontsedailo, D. Antoniuk, O. Korotun, S. Semerikov, I. Mintii, Using Game Dev Tycoon to develop professional soft competencies for future engineers-programmers, CEUR Workshop Proceedings 2732 (2020) 808–822.
- [8] V. Cherniavskiy, H. Popova, M. Sherman, S. Voloshynov, A. Yurzhenko, Mixed reality technologies as a tool to form professional competency of sea transport professionals, CEUR Workshop Proceedings 2740 (2020) 217–231.
- [9] A. Kiv, M. Shyshkina, S. Semerikov, A. Striuk, M. Striuk, H. Shalatska, CTE 2019 - When cloud technologies ruled the education, CEUR Workshop Proceedings 2643 (2020) 1–59. URL: <http://ceur-ws.org/Vol-2643/paper00.pdf>.
- [10] S. Semerikov, I. Teplytskyi, Y. Yechkalo, O. Markova, V. Soloviev, A. Kiv, Computer simulation of neural networks using spreadsheets: Dr. Anderson, welcome back, CEUR Workshop Proceedings 2393 (2019) 833–848. URL: http://ceur-ws.org/Vol-2393/paper_348.pdf.
- [11] M. B. Yevtuch, V. M. Fedorets, O. V. Klochko, M. P. Shyshkina, A. V. Dobryden, Development of the health-preserving competence of a physical education teacher on the basis of

- N. Bernstein's theory of movements construction using virtual reality technologies, CEUR Workshop Proceedings (2021).
- [12] Y. Y. Dyulicheva, D. A. Gaponov, R. Mladenović, Y. A. Kosova, The virtual reality simulator development for dental students training: a pilot study, CEUR Workshop Proceedings (2021).
- [13] Z. Bakum, K. Morozova, Didactical conditions of development of informative-communication competence of future engineers during master preparation, Metallurgical and Mining Industry 7 (2015) 164–167.
- [14] Y. Modlo, S. Semerikov, E. Shmeltzer, Modernization of professional training of electromechanics bachelors: ICT-based Competence Approach, CEUR Workshop Proceedings 2257 (2018) 148–172.
- [15] V. Morkun, S. Semerikov, N. Morkun, S. Hryshchenko, A. Kiv, Defining the structure of environmental competence of future mining engineers: ICT approach, CEUR Workshop Proceedings 2257 (2018) 198–203.
- [16] P. Nechypurenko, V. Soloviev, Using ICT as the tools of forming the senior pupils' research competencies in the profile chemistry learning of elective course "Basics of quantitative chemical analysis", CEUR Workshop Proceedings 2257 (2018) 1–14.
- [17] Z. Bakum, O. Palchykova, S. Kostyuk, V. Lapina, Intercultural competence of personality while teaching foreign languages, Espacios 40 (2019).
- [18] I. Kholoshyn, O. Bondarenko, O. Hanchuk, E. Shmeltser, Cloud ArcGIS Online as an innovative tool for developing geoinformation competence with future geography teachers, CEUR Workshop Proceedings 2433 (2019) 403–412.
- [19] K. Vlasenko, O. Chumak, I. Sitak, O. Chashechnikova, I. Lovianova, Developing informatics competencies of computer sciences students while teaching differential equations, Espacios 40 (2019).
- [20] Y. Kazhan, V. Hamaniuk, S. Amelina, R. Tarasenko, S. Tolmachev, The use of mobile applications and Web 2.0 interactive tools for students' German-language lexical competence improvement, CEUR Workshop Proceedings 2643 (2020) 392–415.
- [21] O. Lavrentieva, V. Pererva, O. Krupskyi, I. Britchenko, S. Shabanov, Issues of shaping the students' professional and terminological competence in science area of expertise in the sustainable development era, E3S Web of Conferences 166 (2020) 10031. doi:10.1051/e3sconf/202016610031.
- [22] Y. Modlo, S. Semerikov, S. Bondarevskyi, S. Tolmachev, O. Markova, P. Nechypurenko, Methods of using mobile Internet devices in the formation of the general scientific component of bachelor in electromechanics competency in modeling of technical objects, CEUR Workshop Proceedings 2547 (2020) 217–240.
- [23] Y. Modlo, S. Semerikov, R. Shajda, S. Tolmachev, O. Markova, P. Nechypurenko, T. Selivanova, Methods of using mobile internet devices in the formation of the general professional component of bachelor in electromechanics competency in modeling of technical objects, CEUR Workshop Proceedings 2643 (2020) 500–534.
- [24] M. Moiseienko, N. Moiseienko, I. Kohut, A. Kiv, Digital competence of pedagogical university student: Definition, structure and didactical conditions of formation, CEUR Workshop Proceedings 2643 (2020) 60–70.
- [25] S. Semerikov, A. Striuk, L. Striuk, M. Striuk, H. Shalatska, Sustainability in Software Engi-

- neering Education: A case of general professional competencies, E3S Web of Conferences 166 (2020). doi:10.1051/e3sconf/202016610036.
- [26] S. Shokaliuk, Y. Bohunenko, I. Lovianova, M. Shyshkina, Technologies of distance learning for programming basics on the principles of integrated development of key competences, CEUR Workshop Proceedings 2643 (2020) 548–562.
- [27] I. Pilkevych, O. Boychenko, N. Lobanchykova, T. Vakaliuk, S. Semerikov, Method of assessing the influence of personnel competence on institutional information security, CEUR Workshop Proceedings 2853 (2021) 266–275. URL: <http://ceur-ws.org/Vol-2853/paper33.pdf>.
- [28] K. V. Vlasenko, I. V. Lovianova, T. S. Armash, I. V. Sitak, D. A. Kovalenko, A competency-based approach to the systematization of mathematical problems in a specialized school, Journal of Physics: Conference Series 1946 (2021) 012003. doi:10.1088/1742-6596/1946/1/012003.
- [29] O. Kravchenko, I. Borisyuk, Z. Vakolia, O. Tretyak, O. Mishchenia, Models of introduction of dual professional education, International Journal of Higher Education 9 (2020) 94–106. doi:10.5430/ijhe.v9n7p94.
- [30] Y. V. Tryus, I. V. Herasymenko, Approaches, models, methods and means of training of future IT-specialists with the use of elements of dual education, Journal of Physics: Conference Series 1840 (2021) 012034. doi:10.1088/1742-6596/1840/1/012034.
- [31] N. Balyk, Y. Vasylenko, G. Shmyger, V. Oleksiuk, A. Skaskiv, Design of approaches to the development of teacher’s digital competencies in the process of their lifelong learning, CEUR Workshop Proceedings 2393 (2019) 204–219.
- [32] V. Osadchyi, H. Varina, E. Prokofiev, I. Serdiuk, S. Shevchenko, Use of ar/vr technologies in the development of future specialists’ stress resistance: Experience of steam-laboratory and laboratory of psychophysiological research cooperation, CEUR Workshop Proceedings 2732 (2020) 634–649.
- [33] O. Kolgatin, L. Kolgatina, N. Ponomareva, E. Shmeltser, Systematicity of students’ independent work in cloud learning environment, CEUR Workshop Proceedings 2433 (2019) 184–196.
- [34] O. Bondarenko, S. Mantulenko, A. Pikilnyak, Google Classroom as a tool of support of blended learning for geography students, CEUR Workshop Proceedings 2257 (2018) 182–191.
- [35] K. Polhun, T. Kramarenko, M. Maloivan, A. Tomilina, Shift from blended learning to distance one during the lockdown period using Moodle: test control of students’ academic achievement and analysis of its results, Journal of Physics: Conference Series 1840 (2021) 012053. doi:10.1088/1742-6596/1840/1/012053.
- [36] K. V. Vlasenko, I. V. Lovianova, O. G. Rovenska, T. S. Armash, V. V. Achkan, Development of the online course for training master students majoring in mathematics, Journal of Physics: Conference Series 1946 (2021) 012001. doi:10.1088/1742-6596/1946/1/012001.
- [37] OMS-VR Maritime trainer, 2021. URL: <https://oms-vr.com/>.
- [38] Q. Wang, Z. Zhe, Y. Xing, Application and research of VR technology in art design teaching, Journal of Physics: Conference Series 1345 (2019) 042026. doi:10.1088/1742-6596/1345/4/042026.
- [39] K. Khan, S. Tolhurst-Cleaver, S. White, W. Simpson, Simulation in Healthcare Education.

- Building a Simulation Program: a Practical Guide, Association for Medical Education in Europe, 2011.
- [40] I. A. Korniienko, B. V. Barchi, Influence of virtual reality tools on human anatomy learning, *Information Technologies and Learning Tools* 77 (2020) 66–75. URL: <https://journal.iitta.gov.ua/index.php/itlt/article/view/3493>. doi:10.33407/itlt.v77i3.3493.
- [41] Y. Wang, Application of virtual reality technique in the construction of modular teaching resources, *International Journal of Emerging Technologies in Learning* 15(10) (2020) 126–139. doi:10.3991/ijet.v15i10.14129.
- [42] Z. Qingtao, Analysis and research on the combination of virtual reality technology (VR) and college sports training, *Journal of Physics: Conference Series* 1486 (2020) 052011. doi:10.1088/1742-6596/1486/5/052011.
- [43] M. Lieze, V. C. Jelle, D. Benedicte, V. de Weghe Nico, M. Mario, D. Van Dyck, Using virtual reality to investigate physical environmental factors related to cycling in older adults: A comparison between two methodologies, *Journal of Transport & Health* 19 (2020) 100921. doi:10.1016/j.jth.2020.100921.
- [44] D. Checa, A. Bustillo, A review of immersive virtual reality serious games to enhance learning and training, *Multimedia Tools and Applications* 79 (2020) 5501–5527. doi:10.1007/s11042-019-08348-9.
- [45] J. L. Rubio-Tamayo, M. Gertrudix Barrio, F. García García, Immersive environments and virtual reality: Systematic review and advances in communication, interaction and simulation, *Multimodal Technologies and Interaction* 1 (2017). URL: <https://www.mdpi.com/2414-4088/1/4/21>. doi:10.3390/mti1040021.
- [46] T. H. Pham, Virtual MET Institution : assessing the potentials and challenges of applying multi-user virtual environment in maritime education and training, Master of Science Thesis in Maritime Affairs, World Maritime University, 2012. URL: https://commons.wmu.se/all_dissertations/20/.
- [47] H. Popova, A. Yurzenko, Competency framework as an instrument to assess professional competency of future seafarers, *CEUR Workshop Proceedings* 2387 (2019) 409–413.
- [48] J. Radianti, T. A. Majchrzak, J. Fromm, I. Wohlgenannt, A systematic review of immersive virtual reality applications for higher education: Design elements, lessons learned, and research agenda, *Computers & Education* 147 (2020) 103778. doi:10.1016/j.compedu.2019.103778.
- [49] M. Lvov, H. Popova, Simulation technologies of virtual reality usage in the training of future ship navigators, *CEUR Workshop Proceedings* 2547 (2020) 50–65.
- [50] R. Raheja, Training simulations in railroad: improving maintenance efficiency, streamlining compliance training, 2021. URL: <https://hwd3d.com/blog/training-simulations-in-railroad-3d-vr-ar/>.
- [51] O. Dimoglova, S. Maksymov, L. Herhanov, Strategic approaches to the formation of professional image of specialists in the conditions of implementation of the model of water transport companies development, *Scientific Bulletin of Naval Academy XXIII* (2020) 159–165. URL: https://www.anmb.ro/buletinstiintific/buletine/2020_Issue1/03_NTM/39.pdf.
- [52] B. Djelloul, An investigation into the feasibility of introducing a marine engine simulator into the Algerian MET [Maritime Education and Training] system, Master of Science

- Thesis in Maritime Affairs, World Maritime University, 2000. URL: http://commons.wmu.se/all_dissertations/76.
- [53] C. Sellberg, Training to become a master mariner in a simulator-based environment: The instructors' contributions to professional learning, Ph.D. thesis, University of Gothenburg, 2018. URL: <http://hdl.handle.net/2077/54327>.
- [54] Y. Sendi, Integrated Maritime Simulation Complex Management, Quality And Training Effectiveness From The Perspective Of Modeling And Simulation In The State Of Florida, USA (A Case Study), Masters of Science Thesis, University of Central Florida, 2015. URL: <https://stars.library.ucf.edu/etd/1399/>.
- [55] O. Lindmark, A teaching incentive: The Manila amendment and the learning outcome in tanker education, Master of Science Thesis in Nordic Master in Maritime Management, Chalmers University of Technology, 2012. URL: https://www.academia.edu/29555065/A_teaching_incentive.
- [56] A. Ali, Role and importance of the simulator instructor, Master of Science Thesis in Maritime Affairs, World Maritime University, 2006. URL: https://commons.wmu.se/all_dissertations/282/.
- [57] Virtual reality – maritime simulators training for seafarers, 2017. URL: <https://www.nauticalsimulation.com/virtual-reality-maritime-simulators-training-seafarers/>.
- [58] T. Lodder, The bright future of VR in maritime & offshore, 2015. URL: <https://www.xvrsim.com/en/news/the-bright-future-of-vr-in-maritime-offshore/>.
- [59] The Editorial Team, How virtual reality is transforming training, 2018. URL: <https://safety4sea.com/visual-reality-transforming-training>.
- [60] VR Training Simulation of Electrical Safety, 2020. URL: <https://khora.com/project/vr-training-simulation-of-electrical-safety/>.
- [61] Custom solutions, 2010. URL: <https://www.morildinteraktiv.no/custom>.
- [62] R. U. A. Khan, The influence of educational technology on affective education in maritime education and training (MET), Master of Science Thesis in Maritime Affairs, World Maritime University, 2014. URL: https://commons.wmu.se/all_dissertations/456/.
- [63] E. G. Fedorenko, N. V. Kaidan, V. Y. Velychko, V. N. Soloviev, Gamification when studying logical operators on the Minecraft EDU platform, CEUR Workshop Proceedings (2021).
- [64] On Approval of Standard of Higher Education of Ukraine, Specialty 271 River and Sea Transport for the First (Bachelor) Level of Higher Education : Order of MES of Ukraine dated 13.11.2018, 2018. URL: <https://mon.gov.ua/storage/app/media/vishcha-osvita/zatverdzeni%20standarty/12/21/271-richkoviy-ta-morskiy-transport-bakalavr.pdf>.
- [65] E. Belykh, Experimental models for neuro-surgery training in clipping of middle brain arteria aneurism and application of micro-anastomoses, Ph.D. thesis, Novosibirsk Research Institute of Traumatology and Orthopedics, Novosibirsk, 2016.

Selection of online tools for creating math tests

Oksana V. Zaika¹, Tetiana A. Vakaliuk^{2,3,4}, Andrii V. Riabko¹, Roman P. Kukharchuk¹, Iryna S. Mintii^{3,4} and Serhiy O. Semerikov^{3,4,5,6}

¹Olexander Dovzhenko Glukhiv National Pedagogical University, 24 Kyievo-Moskovska Str., Glukhiv, 41400, Ukraine

²Zhytomyr Polytechnic State University, 103 Chudrivska Str., Zhytomyr, 10005, Ukraine

³Kryvyi Rih State Pedagogical University, 54 Gagarin Ave., Kryvyi Rih, 50086, Ukraine

⁴Institute of Information Technologies and Learning Tools of the NAES of Ukraine, 9 M. Berlynskoho Str., Kyiv, 04060, Ukraine

⁵Kryvyi Rih National University, 27 Vitalii Matusevych Str., Kryvyi Rih, 50027, Ukraine

⁶University of Educational Management, 52-A Sichovykh Striltsiv Str., Kyiv, 04053, Ukraine

Abstract

The article considers online tools for creating tests, which should be used when teaching mathematics in both higher education and general secondary education. Among the variety of online means of creating tests by the method of expert evaluation, three were identified, which allow conducting various tests both in the classroom and remotely, which are free and do not require special conditions for their use and which work on smartphones. The advantages and disadvantages of three online tools for creating tests Kahoot!, Quizizz, Classtime are analyzed, and a comparative description of the selected tools is given. Criteria for the selection of such tools were identified – functional-didactic and organizational. The following indicators belong to the functional-didactic: the presence of different types of questions, including open-ended; use of formulas, both in questions and in answers; use of pictures, both in questions and in answers; no restrictions on the length of questions and answers; instant receipt of results by the teacher, their evaluation and analysis; instant receipt of results by the respondent; to the organizational: the availability of a free version; no need to install the program; ease of use – characterizes the convenience and clarity of the interface for creating tests and their use; possibility of testing in online and offline mode; time limits, both for a single question and the whole test; random order of questions/answer options; instant demonstration of the correct answer to the respondent. With the help of expert evaluation, it was found that according to these criteria, Quizizz is the most appropriate for testing.

Keywords

online tools, Kahoot!, Quizizz, Classtime

AREdu 2021: 4th International Workshop on Augmented Reality in Education, May 11, 2021, Kryvyi Rih, Ukraine

✉ ksuwazaika@gmail.com (O. V. Zaika); tetianavakaliuk@gmail.com (T. A. Vakaliuk); ryabko@meta.ua

(A. V. Riabko); kyxap4yk1@ukr.net (R. P. Kukharchuk); irina.mintiy@kdpu.edu.ua (I. S. Mintii);

semerikov@gmail.com (S. O. Semerikov)

🌐 <http://pfm.gnpu.edu.ua/index.php/struktura1/2015-04-01-14-50-26> (O. V. Zaika);

<https://sites.google.com/view/neota> (T. A. Vakaliuk);

<http://pfm.gnpu.edu.ua/index.php/struktura1/2015-04-01-14-50-26> (A. V. Riabko);

<http://pfm.gnpu.edu.ua/index.php/struktura1/2015-04-01-14-50-26> (R. P. Kukharchuk);

<https://kdpu.edu.ua/personal/ismintii.html> (I. S. Mintii); <https://kdpu.edu.ua/semerikov> (S. O. Semerikov)

🆔 0000-0002-8479-9408 (O. V. Zaika); 0000-0001-6825-4697 (T. A. Vakaliuk); 0000-0001-7728-6498 (A. V. Riabko);

0000-0002-7588-7406 (R. P. Kukharchuk); 0000-0003-3586-4311 (I. S. Mintii); 0000-0003-0789-0272 (S. O. Semerikov)

© 2021 Copyright for this paper by its authors.
Use permitted under Creative Commons License Attribution 4.0 International (CC BY 4.0).



CEUR Workshop Proceedings (CEUR-WS.org)

1. Introduction

1.1. The problem statement

The COVID-19 pandemic has made an irreversible change in the normal existence of all people [1, 2, 3, 4, 5, 6], but it has changed the lives of those involved in the education system the most – both teachers and students [7, 8, 9]. The organization of distance learning (DL) in the spring of 2020 showed the existence of a range of problems in the mechanism of providing education by distance, in particular – the choice of DL technologies, time distribution between synchronous/asynchronous mode, accounting for working time and wages [10, 11, 12]. The solution to these problems is proposed in the Regulation on the distance form of complete general secondary education [13], adopted in the autumn of the same year. Thus, it states that to ensure uniform approaches to the creation of an electronic educational environment in the educational institution, the pedagogical council approves the use of specific information and telecommunication systems (electronic educational platforms), online communication services, and tools used to organize the educational process during DL. Within the framework of such unified approaches, pedagogical workers, using academic freedom, can choose forms, methods, and means of DL [13]. However, to make a considered and balanced choice of “specific information and telecommunication systems (electronic educational platforms), online communication services and tools” it is necessary to know their advantages, disadvantages, opportunities. Therefore, during quarantine, teachers are forced to “not only teach, but also to master new technologies” [14].

An integral part of the learning process (and not only distance) is the control and assessment, which can be carried out “in the process of daily study of students’ learning outcomes in class and at home, as well as the results of testing student achievement: oral, including individual, group and face-to-face interviews; written, in particular, independent and control works, testing” [15].

In [13] it is determined that “assessment of students’ learning outcomes can be carried out in person or remotely using the capabilities of information and communication (digital) technologies, including video conferencing”.

However, all the same, quarantine restrictions require online assessment. The use of online services for testing provides an opportunity to monitor and evaluate student achievement in various forms, set up automatic assessment and analysis of answers, instantly provide the student with test results, etc.

Currently, teachers have access to some such services – it’s Google service, Classtime, Online Test Pad, Eazy Test Maker, Kahoot!, Quizizz etc. By what criteria do you compare these online tools? What can be neglected, and what should be paid special attention to is the question of the study.

1.2. Analysis of recent research and publications

The issue of DL was particularly acute during the COVID-19 pandemic, but scientists around the world have been working on it for years. Teaching mathematics using DL technologies has long been studied by a team of scientists from Donbass State Engineering Academy, Donbass National Academy of Civil Engineering and Architecture, The Institute of Chemical Technologies (the

town of Rubizhne) of the East Ukrainian Volodymyr Dahl National University and Kryvyi Rih State Pedagogical University chaired by Kateryna V. Vlasenko, who are developers of the open platform of online education “Higher School Mathematics Teacher”. The purpose of this platform is “how to teach a student, who gets engineering education, to study mathematics”. *Differential Equations* and *Operations Research* oriented to cloud computing in the CoCalc system are currently available on the platform. Vlasenko et al. [16] highlight as a process of using this platform for online training of master students, majoring in Mathematics for internship in technical universities, issues that may arise in students during the internship, discuss the need to consider needs of students during the development of courses, and certain features of the platform, in particular, justify its minimalist interface [17] and explore the criteria of usability [18]: information quality, system navigation, system learnability, visual design, instructional assessment, and system interactivity and responsiveness.

Representatives of the Myroslav I. Zhaldak’s scientific school also highlight the experience of using DL technologies for teaching mathematics on the example of the use of cloud technology in mathematical calculations, use of Gran1, Gran2D, Gran3D software [19]: “In particular, the calculation of the approximate value of the double integral; graphical two-dimensional problem solving, the so-called linear programming problems; two-dimensional problems, including convex programming – finding the smallest value of a convex downward function (or the highest convexity of a function) on a convex set of inequalities (including linear ones)”.

Kramarenko et al. [20] improve the study of mathematics by using cloud technologies and dynamic mathematics system GeoGebra in the educational process through Stereometry specialized training.

Kramarenko et al. [21] investigate the problem of studying mathematics using ICT in the inclusive class; Lovianova et al. [22] – the problem of introducing cloud calculations into 10th-11th graders’ training to solve optimization problems in the context of the STEM education concept; Shyshkina and Marienko [23] 0- the task of improving the math teachers’ ICT competence using cloud services use in the training process.

Bobyliiev and Vihrova [24] demonstrate the method of DL of mathematics using LMS Moodle on the example of the courses “Mathematical Analysis” and “History of Mathematics”.

It is worth noting that LMS Moodle is one of the most popular platforms to support DL not only in Ukraine but also around the world. However, studies by different authors focus on different aspects of its use. For example, The and Usagawa [25] developed a pilot e-learning program based on online quizzes. The obtained results testified to the higher marks on the final test of students after self-study and practice using online quizzes. Smoline [26] discusses some inconsistencies in testing that are characteristic of some LMS, in particular, Moodle and Blackboard. However, a special test description language is offered, designed specifically for math tests. Gangur [27] also investigates the activities of students within a particular LMS in terms of mathematical problems. They mainly offer to organize educational activities using tests with automatically-generated questions. They also demonstrate the solution of certain problems related to the creation of mathematical problems with parameters.

About online testing and testing in general by e-learning, this issue is similarly considered by scientists for more than a year in various fields. Thus, Rakov et al. [28] investigated data processing technologies for calculating the prognostic validity of tests of academic achievement, Tarasenko et al. [29] proposed an integrated system for testing the components of information

competence of future translators. Also, Shapovalova et al. [30] proposed an adaptive testing model as a method of individualization of knowledge quality control, and Mrela and Sokolov [31] proposed to put students' ratings on based on the assessment by experts of the levels of verification of learning outcomes on test tasks.

Some authors have explored the possibilities of LMS in test control of knowledge, in particular, Abdula et al. [32] investigated the features of the use of Moodle test tools in teaching philosophy, and Mintii et al. [33] considered the possibility of importing test questions into LMS Moodle.

Regarding the teaching of mathematics, Lvov and Shmarova [34] studied the generation of test problems in computer mathematics systems for educational purposes.

Some online testing tools are discussed in [35, 36, 37, 38, 39, 40, 41, 42].

Thus, Jiemsak and Jiemsak [35] identified the capabilities of the Quizizz service as a tool for evaluation and self-evaluation. According to the results of the experiment, students were positive about self-esteem using Quizizz.

Chaiyo and Nokham [36] showed the results of the impact of using Kahoot, Quizizz, and Google Forms services on concentration, involvement in the process, results, motivation, and satisfaction. The obtained results testified to the presence of significant differences.

Anderson [37] explores the possibility of using Google Forms for online surveys designed to gather feedback on the daily coverage of students with the content of training and the distribution of classroom time. These surveys help to get feedback on uncompleted tasks. The experiment was conducted in a variety of mathematical courses – from calculus to abstract algebra, which influenced the success, participation, and reach of students.

Popescu and Avram [38] consider Google Forms as a tool for monitoring the complex activities of project participants at different stages of compliance with the planned results. The authors note that Google Forms is a simple tool that has an intuitive interface, allows you to get instant results and user feedback.

McConnel [39] also suggests using Google Forms to increase student engagement. But they purposefully use open daily thinking to allow students to take responsibility for their learning (not the question “Why did you learn during this week”, but for example, “Is there something you want me to know?”). This gives students the opportunity to talk more openly about group work, social issues and topics of interest to them, and the data collected is useful for teachers to build more trusting relationships.

Some works are devoted to the use of Kahoot! in the educational process and service. Thus, Aras and Çiftçi [40] conducted a study to compare the impact on the consolidation of traditional survey material and using the Kahoot! service, but no statistical differences were found. In the work of Pereira de Sousa [41] the results obtained indicate that the use of the service Kahoot! for the joint development and use of quizzes and tests provided an opportunity to gamify learning and led to greater involvement of students in the course, and, as a consequence, contributed to a more conscious work on the course.

Domínguez et al. [42] also focuses on the capabilities of Kahoot! and Classtime services to gamify learning and thus turn a regular teacher survey into a competition.

Other authors are trying to integrate some of the existing services. Thus, Wildgoose and Bakrania [43] have developed a new evaluation tool that combines the capabilities of Google Forms and the versatility of complex task development with multiple choice in Google Sheets. Using this tool allows teachers to create a library of questions, edit numerical parameters that

update the formulated answers (which is essential for mathematical disciplines), select questions, and perform the instant evaluation. The results of the experiment showed greater involvement of students.

When researching the characteristics of online tools, it is worth paying attention to the results of Nielsen [44], who was one of the first to use the term “usability” – the ease of use of the software. In particular, Nielsen [44] identifies the following criteria: “the user can determine the state of the system; the system uses user-friendly terminology; free control of the system, support for the function of deletion (undo) and repetition function (redo); consistency and standards; prevention of errors and warning the user about further problems; minimization of the load on the user’s memory; flexibility and efficiency of use; aesthetic and minimal design; the system should offer the user a constructive solution to emerging issues; availability of reference information in the system”.

Thus, we see that scientists are working fruitfully to study the use of DL technologies for teaching mathematics, explore the possibilities of individual tools, but need a comprehensive study of the most popular online testing services with an emphasis on the peculiarities of their use for mathematical problems.

Therefore, the *purpose* of the article is a method of expert selection to select according to certain criteria and indicators of online means of creating tests for use in the professional activities of mathematics teachers.

2. Methods

To identify an appropriate online tool for creating tests for teaching mathematics to both students of higher education institutions and students of general secondary education, the method of expert assessment was used [45]. The experts were interviewed in two stages.

Consider them. The first stage of the survey of experts. Specialists were asked to evaluate 6 test programs that can be used to teach mathematics in educational institutions, and which are adapted for smartphones. Teachers and teachers of mathematics (12 people in total) were involved for expert evaluation. The study was conducted based on Olexander Dovzhenko Glukhiv National Pedagogical University.

As part of our study, they used the scoring system proposed in [45], according to which for the number of 6 tools - the maximum score of 6 will receive the most important test platform in use, and the lowest score of 1 will receive the least significant. To establish the existence of an objective agreement between experts, the Kendall’s coefficient of concordance is determined [45].

After performing the necessary calculations using experimental data, we obtain a certain value of the Kendall’s W . In the case of a significant difference from zero, the calculation results determine the existence of an objective agreement between experts ($W = 0$ – no link between ranking experts, $W = 1$ – ranking completely coincide), the total ranks are quite objective.

In the second stage of the study, a group of experts was involved to determine the most significant test platforms according to certain criteria. The manifestation of each of the given criteria was evaluated for each of these means of testing students on the appropriate scale [45].

The indicator is considered positive if the value of the arithmetic mean of all indicators of

this criterion is not less than 1.5 [46]. The criterion is:

- insufficiently manifested, if more than 50% of its indicators are negative;
- critically manifested, if 50% – 55% of its indicators are positive;
- sufficiently pronounced if 56% – 75% of its indicators are positive;
- and highly manifested, if 76% – 100% of its indicators are positive

3. Results

To identify an appropriate online tool for creating tests while teaching mathematics, (including future teachers of mathematics), we will use the method of expert assessment, which is described in detail above. To compile a list of proposed online test-taking tools, a survey of teachers and educators directly involved in teaching mathematics in the institutions of higher education and the general secondary education institutions was conducted to determine which online test-taking tools are preferred in different educational institutions.

As a result, the following list of Classtime, Google Forms, Online Test Pad, Eazy Test Maker, Kahoot, Quizizz was formed.

However, it should be noted that not all of these services have the characteristics that should be in the means of mathematical orientation. Thus, one of the important characteristics is the ability to use formulas (both in questions and answers), the use of figures (again, both in questions and answers), changes in parameters in formulas, etc.

At the first stage, the experts were asked to take a survey to rank the selected test programs on a scale from 1 (minimum score) to 6 (maximum score). The survey results are presented in the table 1.

Table 1
Ranking of online tools for creating tests in teaching mathematics

Number of expert	Tools					
	Classtime	Google Forms	Online Test Pad	Eazy Test Maker	Kahoot	Quizizz
1	5	3	1	4	2	6
2	6	3	1	2	4	5
3	4	3	2	1	6	5
4	6	2	1	4	3	5
5	3	4	1	2	5	6
6	6	3	2	1	5	4
7	4	3	2	1	6	5
8	3	5	6	1	2	4
9	4	3	1	2	6	5
10	5	2	6	1	3	4
11	3	5	6	1	2	4
12	5	3	1	2	4	6
S	54	39	30	22	48	59
d	12	-3	-12	-20	6	17

After performing the calculations according to the appropriate formulas, we have $W = 0.41$, i.e. the Kendall's coefficient of concordance is different from zero, and therefore there is an objective agreement between the experts. As a result, three test platforms Classtime, Kahoot, Quizizz were selected. Consider their advantages and disadvantages of their use in the educational process to control the educational achievements of students.

Kahoot!. There are different Kahoot! tariff plans [47]. The simplest in terms of equipment and free is the basic tariff plan, which includes:

- involvement of students (in the classroom and through video; tasks with students);
- creation of the test (ready tests, bank of questions, to create own collections of questions);
- types of questions (test with answer options (one of four), yes / no);
- assessment (training with video conferences, reports for the formation of assessment);
- settings (login generator, music options);
- cooperation (1 group of teachers).

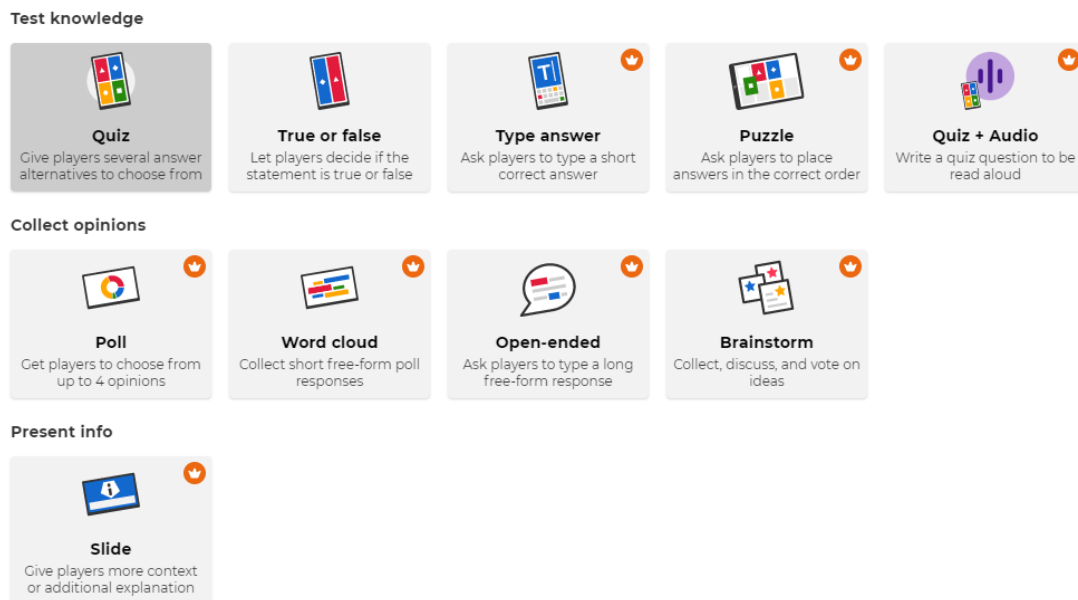

Figure 1: Types of tests in Kahoot!.

Consider the main features of this tool:

- There are several options for work: testing can take place online (virtual classroom), and you can take the test without contacting the teacher (self-study). Here the teacher sets the date and time limit during which the test will be open.
- There are different tariff plans: free and premium, for a certain price. But the free version is enough to quickly check the assimilation of certain material by students, both in

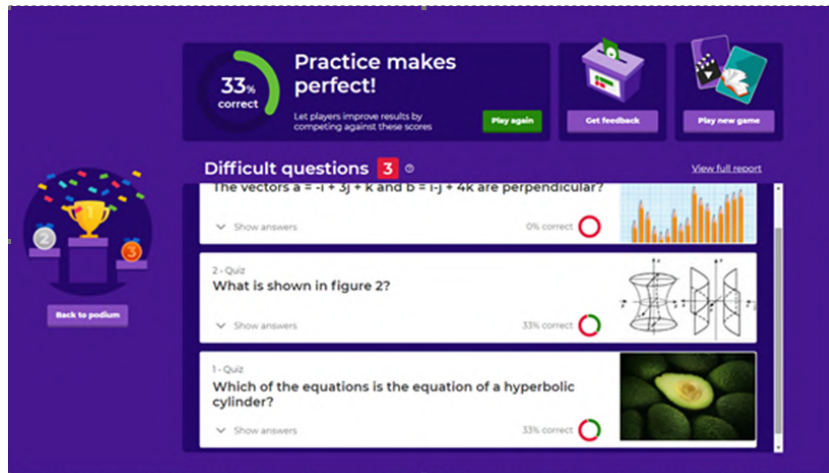

Figure 2: Test results.

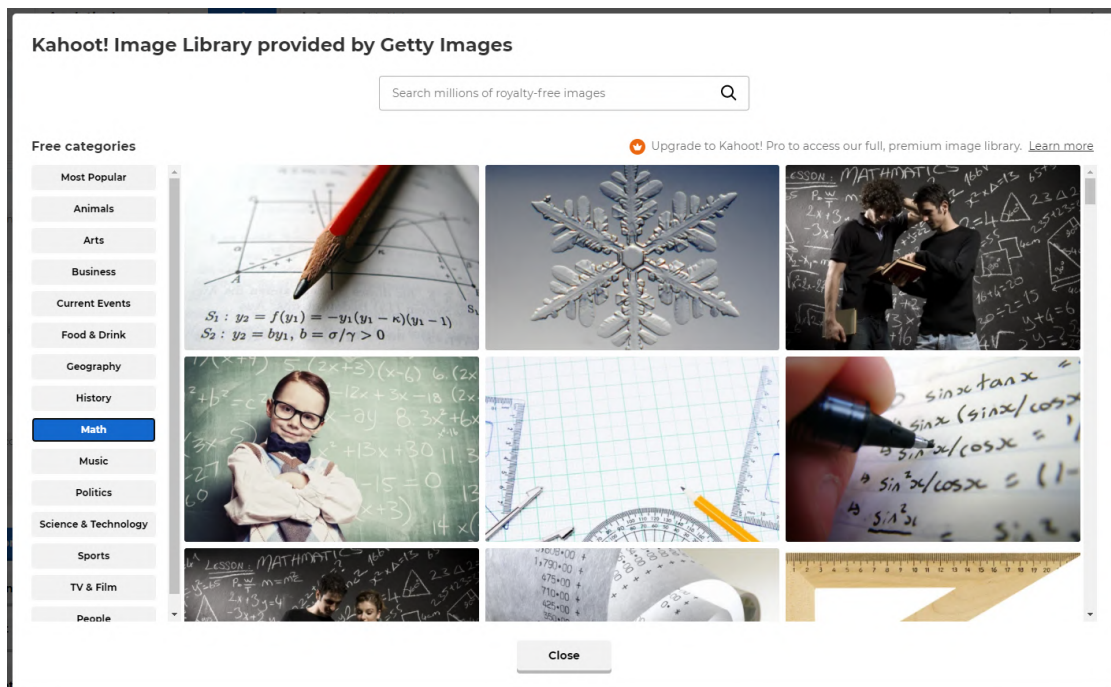

Figure 3: Categories of images.

preparation for the classroom – repetition of the necessary material, and in the final control.

- Premium class gives more opportunities in choosing the format of tests. In the premium class there is an opportunity to add your answer, both short and detailed; arrange the

answers in a certain order; add associations with a certain concept; express their opinions to create a dispute, etc. (figure 1).

- No need to download programs. All you have to do is go to Kahoot.it from your computer or smartphone, enter the PIN code of the test suggested by the teacher, and then – your name and start the game. During DL, it is necessary to connect participants to the video conference using any platform and display the question. When answering questions, each participant immediately sees where he is wrong. At the end of the test, the three best answers are displayed (up to 50 people can play at the same time in the free version), and the teacher has a report indicating the students with the number of points they scored and the most difficult questions (figure 2).
- You can set the time from 5 sec. to 240 sec. to think about the answer, the default is 20 sec. This makes it possible to set the pace of work during testing.
- It is possible to supplement the question with an image that can be meaningful – to supplement the question, to push the answer, or just a fun picture. Such images can be taken from your document, or you can use the ones already offered. There are different categories of images on different topics (figure 3).

Figure 4 shows what the field for creating a free quiz test looks like. You fill in questions, answers, set time limits, add images (figure 5).

- When the teacher chooses to “Play”, it is possible to establish the following points: a random order of questions and answers, which is very convenient for repeated testing, musical accompaniment, etc. (figure 6).

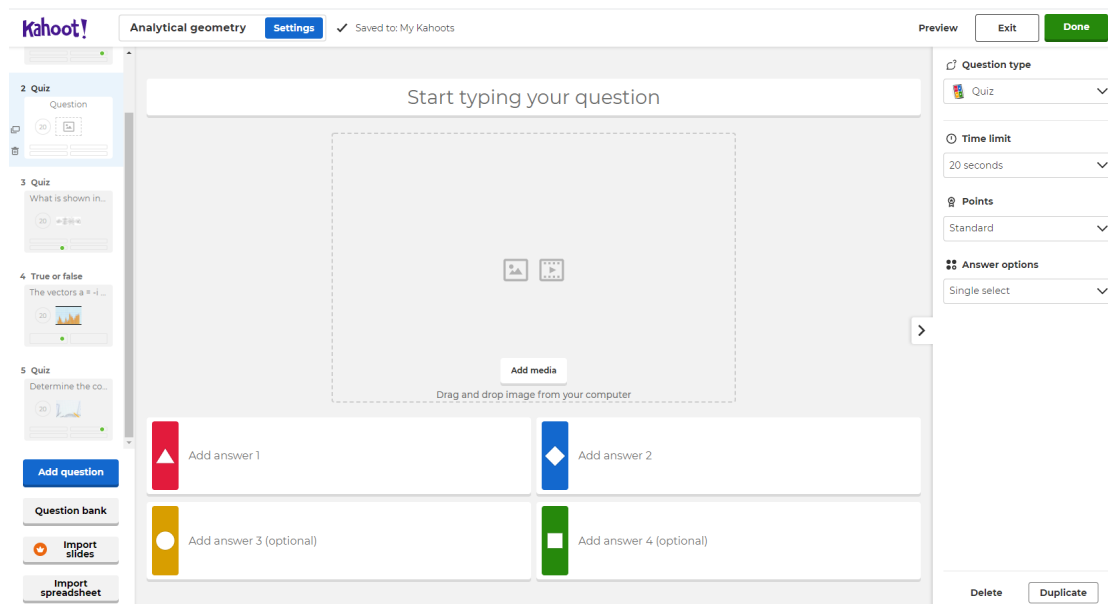

Figure 4: Question form template: initial.

What is shown in figure 2?

⊕
⊖
Skip

15

0
 Answers

▲ ellipsoid

◆ elliptical cylinder

● single-cavity hyperboloid

■ hyperbolic cylinder

Figure 5: Question form template: image – question.

Player vs Player
1:1 Devices

Classic

Team vs Team
Shared Devices

Team mode

Game options ▼

Enable Answer Streak Bonus View details	ON <input type="checkbox"/>
Name generator View details	ON <input type="checkbox"/>
Podium View details	ON <input type="checkbox"/>
Randomize order of questions	ON <input type="checkbox"/>
Randomize order of answers	ON <input type="checkbox"/>
Enable 2 Step Join View details	OFF <input type="checkbox"/>
Display Game PIN throughout	ON <input type="checkbox"/>

Figure 6: Game settings.

Using Kahoot! helps to correctly assess the knowledge of the student, being away from him. Tests can be used to update basic knowledge before a class, in particular, online, for a module test, final test, exam preparation, or test.

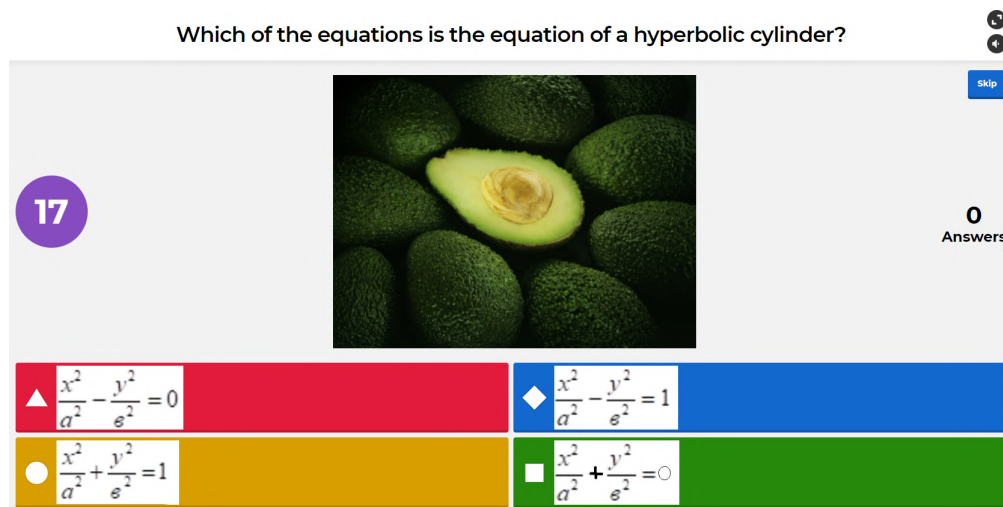

Figure 7: Answers-images.

The disadvantages of this program include:

- Lack of Ukrainian interface (there are English and Russian), automatic translation of Ukrainian text in the program in the finished test during the game.
- In the free version, only two types of tests are available: “Quiz” – the choice of one correct answer out of four, and the choice of “Yes / No”.
- Lack of formula editor. Although uppercase and lowercase modes are available in the answers. Formulas can also be inserted in the answer in the form of images (figure 7). In question, it is possible to recruit them using common notation.
- When creating a question, the teacher should think about the following: the question should be formulated, concisely, concisely. The answers should also be short (there is a limit on the number of words).
- During the online game, respondents do not see questions and answer options on their smartphones, they have only four cards; this is not always convenient, because you need to read the questions from the screen and not make a mistake (automatically) in choosing the picture.

Classtime. This online test creation tool is free, although it also offers a premium version that extends certain capabilities (for example, the ability to connect a group you already work within Google Classroom, set a time limit for the task) [48].

The advantages include:

- Availability of Ukrainian interface.

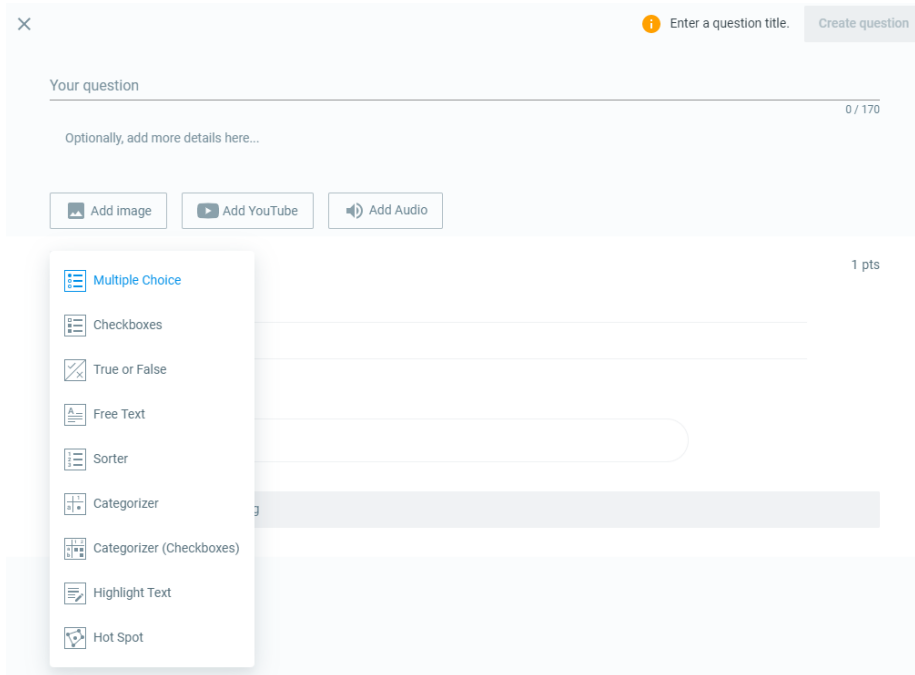

Figure 8: Types of tests in Classtime.

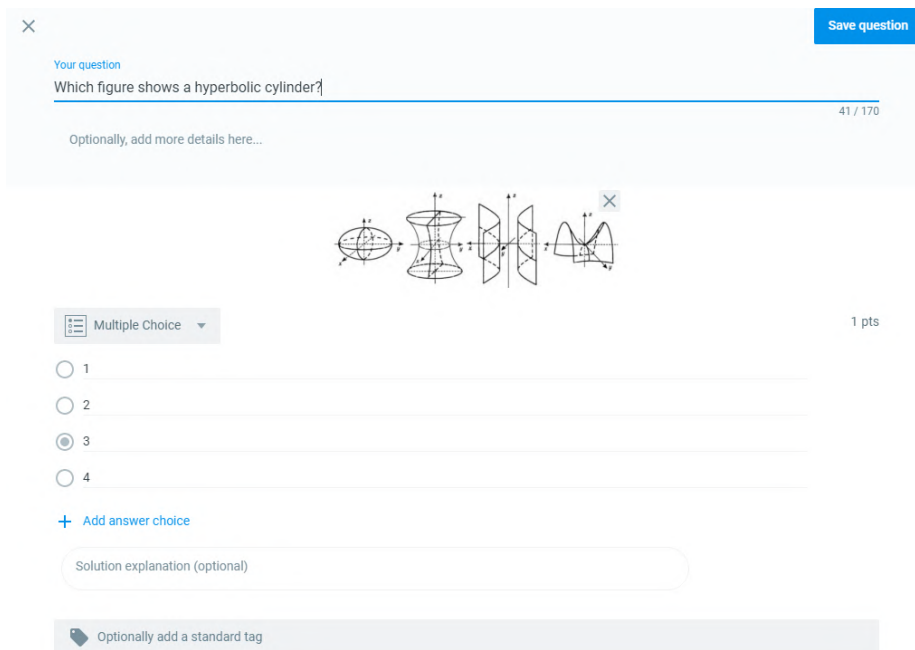

Figure 9: Adding an image in question; b) in response.

✕ Save question

Your question

What equation does the cone specify?

36 / 170

Optionally, add more details here...

Multiple Choice 1 pts

Answer choice 1

$\frac{x^2}{a^2} + \frac{y^2}{b^2} - \frac{z^2}{c^2} = 0$

Answer choice 2

$\frac{x^2}{a^2} - \frac{y^2}{b^2} - \frac{z^2}{c^2} = 0$

Answer choice 3

$\frac{x^2}{a^2} + \frac{y^2}{b^2} - \frac{z^2}{c^2} = 1$

[+ Add answer choice](#)

Solution explanation (optional)

Optionally add a standard tag

Figure 10: Adding an image in response.

- The free version allows you to create tests of nine types: choosing one answer from the proposed, choosing several correct, matching, adding your answer, and others (figure 8).
- Ability to add images both in question and in response (images can be taken from your documents, as well as from the Internet) (figures 9, 10).
- When the teacher chooses to “Play”, it is possible to establish the following points: a random order of questions and answers, which is very convenient for repeated tests, the correct answer immediately or not, and more (figure 11).
- No need to download programs. The student comes by invitation and starts the game. Depending on the teacher’s actions, the participant either sees his mistakes immediately, or only the teacher announces his assessment.
- The teacher sees the table of answers, can conclude the complexity of the questions (what material was not mastered) and the number of points. If the type of question “own answer” was chosen, the teacher must assess the correctness of the answer (figure 12).

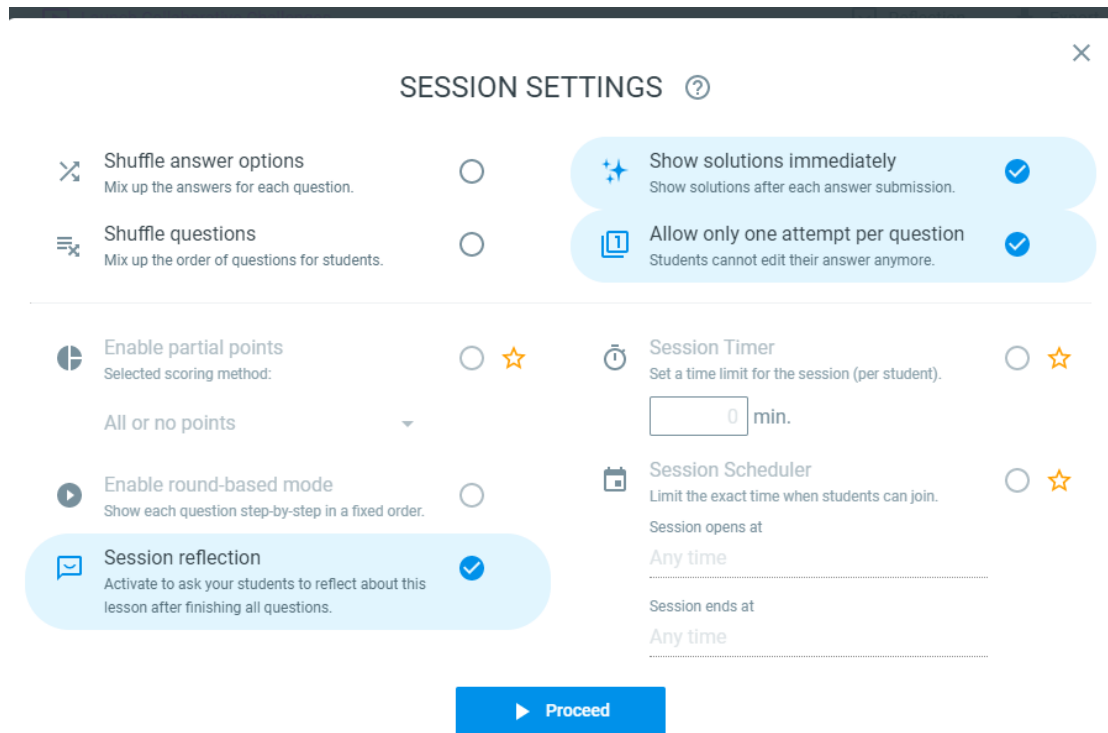

Figure 11: Game rules.

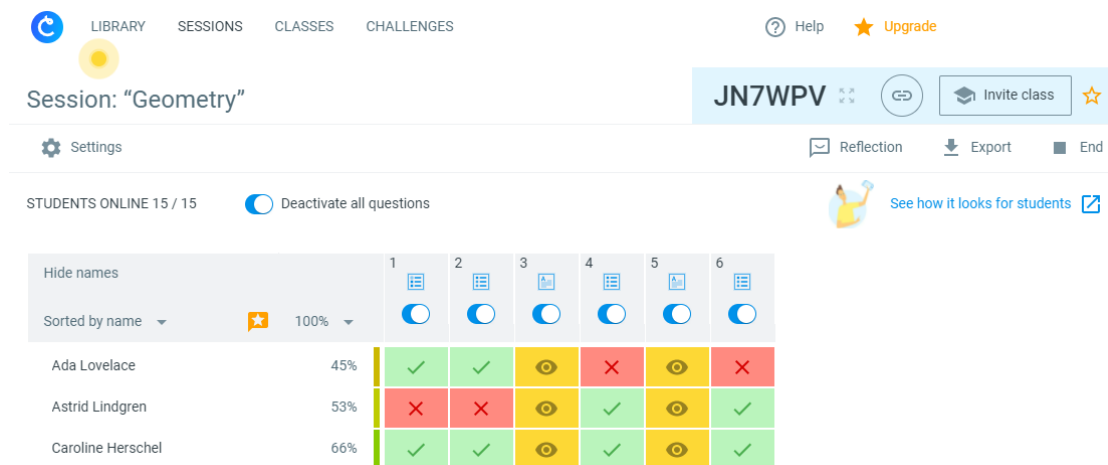

Figure 12: Test evaluation table.

The disadvantages include:

- Lack of formula editor. Formulas can be typed in the accepted format, i.e., for example, root – sqrt, and so on.
- The appearance of the test is a plain white sheet of paper with questions.
- It is not possible to set the time for the task in the free version (this option is present in the premium class).
- To start the game, the teacher must invite each participant by sending him an invitation and specifying the game code.
- The teacher does not control the pace of the task. It can only warn students that the test can be taken for a certain period and do not accept answers after the deadline.

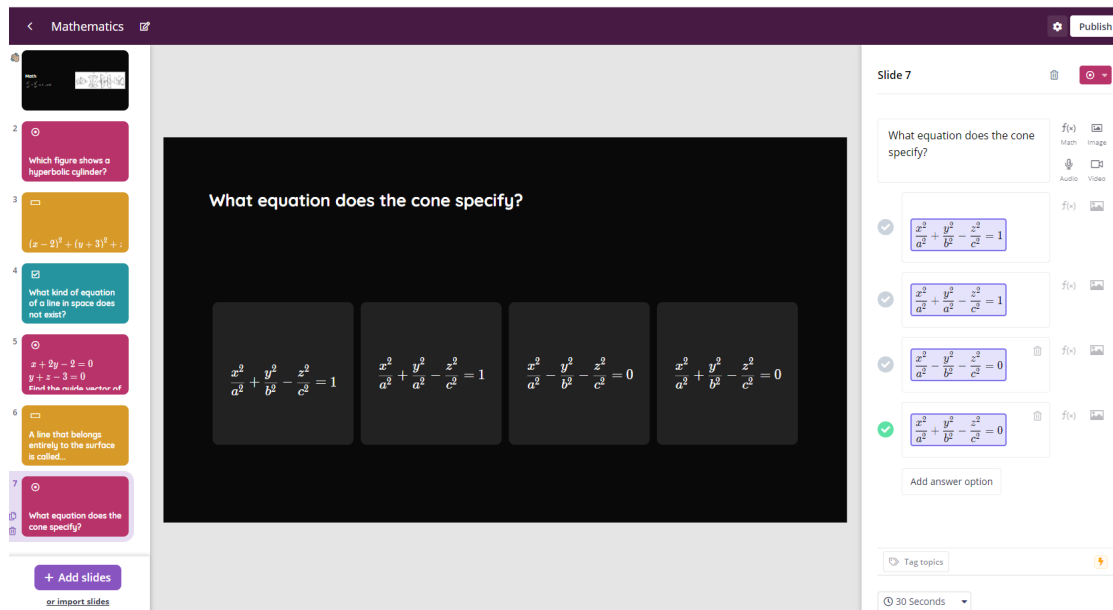

Figure 13: Formulas in tests.

Quizizz [49] is an online test creation tool. Here are the main features of this tool:

- No need to download programs. Just go to join.quizizz.com and enter the code suggested by the teacher.
- Available formula editor. Formulas can be typed both in the question and in the answers (figure 13).
- There are five types of tests available: choosing one answer, choosing several answers, adding your answer, questioning, reasoning. Also, you can choose ready-made questions from the Internet, if it suits you by topic (figure 14), or add slides.
- Ability to add images to both questions and answers. You can also add audio and video to the question.
- Bright interface of the question, which the test participant sees in his smartphone or computer (figure 15).

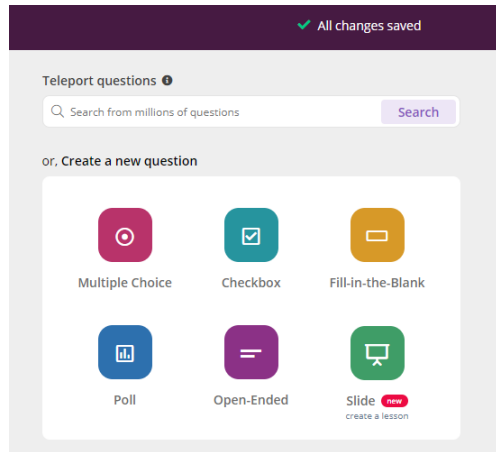

Figure 14: Types of tests.

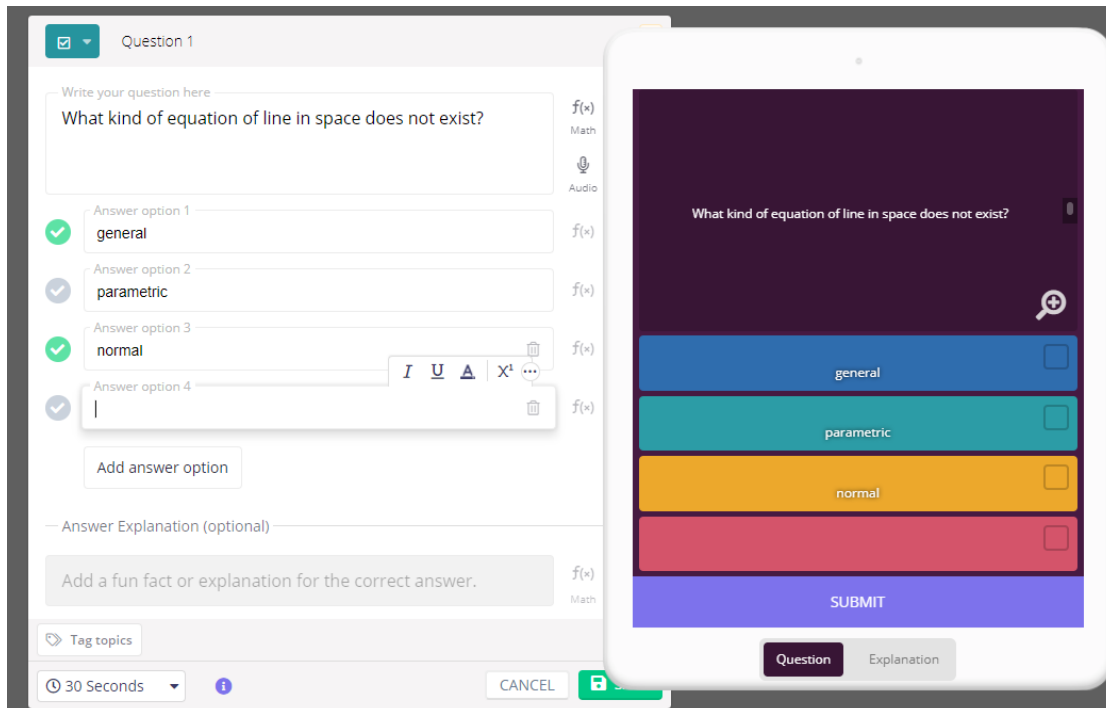

Figure 15: Interface questions.

- It is possible to set the pace of testing. Students can take the test at their own pace (during class or as homework), and the teacher can control the change of questions (online testing) so that participants can complete the test at the same time. Each question is set the maximum time allotted for its implementation (from 5 seconds to 15 minutes).

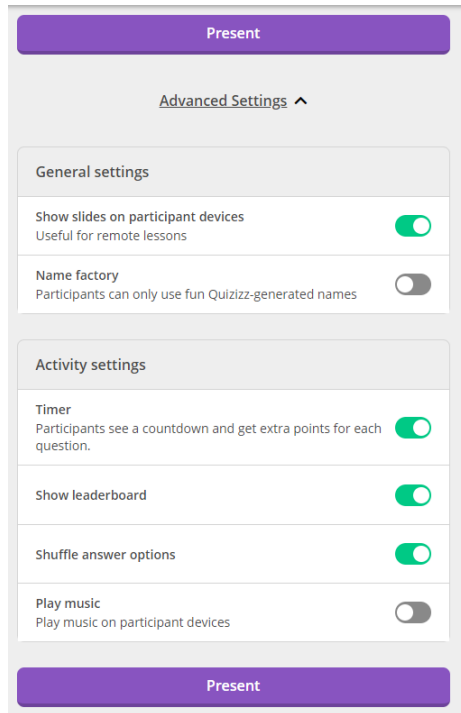

Figure 16: Game settings.

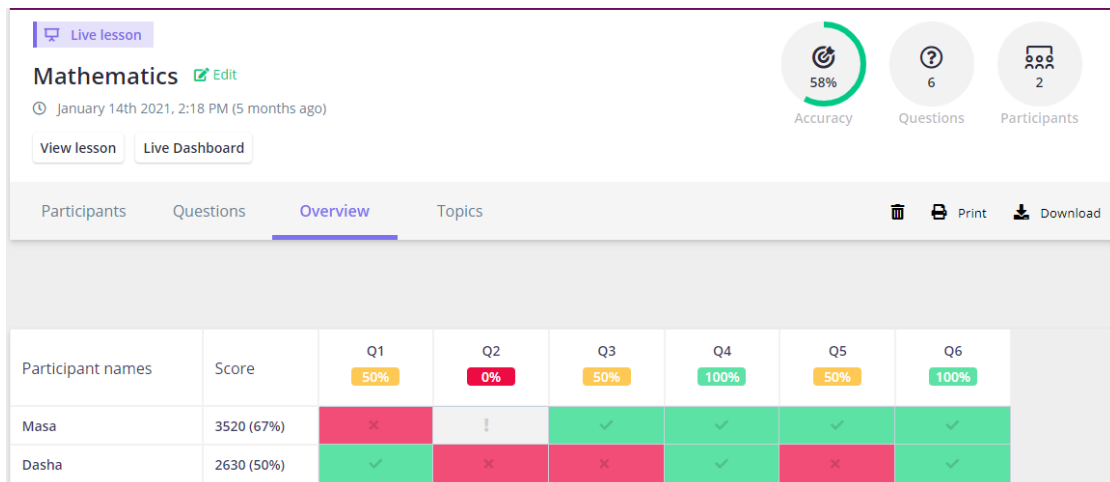

Figure 17: Test results.

- It is possible to customize the game (rearrange questions and answers, show the correct answer after the selection, show all the questions at the end of the game, etc.) (figure 16).
- On the teacher's screen you can immediately see the test results, the statistical table. The

results are presented in the form of a table, which can be used to assess which questions caused difficulties (have the largest number of incorrect answers, have a lot of time, etc.) (figure 17), it is possible to export the results to the Excel table; also, the teacher sees statistics on the completed homework (“My Reports”).

As for the shortcomings, this tool contains only the English and Russian interfaces, and the evaluation is influenced by the speed of the response (i.e. the phlegmatic already loses, even if he gives the correct answer).

The comparative analysis of the considered means gave the chance to form two criteria – functional-didactic and organizational, to each of which the group of properties on which further in research each of means will be estimated belongs. Thus, the first group (functional-didactic criterion) includes properties that characterize the functional and didactic component of the tool for testing:

- 1) the presence of different types of questions, including open-ended;
- 2) the use of formulas, both in questions and answers;
- 3) the use of pictures, both in questions and answers;
- 4) no restrictions on the length of questions and answers;
- 5) instant receipt of results by the teacher, their evaluation and analysis;
- 6) instant receipt of results by the respondent.

The results of the intermediate data of the expert survey on the functional-didactic criterion are given in the tables 2, 3 and 4.

Table 2

The results of assessment according to the functional-didactic criterion Kahoot!

№	The number of points for the indicator №					
	1	2	3	4	5	6
1	1	0	2	0	3	3
2	1	0	2	1	3	3
3	1	0	3	1	3	3
4	1	0	3	1	3	3
5	1	0	2	1	3	3
6	1	0	2	0	3	3
7	1	0	2	0	3	3
8	1	0	3	0	2	3
9	1	0	3	1	3	3
10	1	0	3	1	3	3
11	1	0	2	0	3	3
12	1	0	2	0	3	3
average	1	0	2.42	0.5	2.92	3

Let’s highlight the results of the indicators of functional and didactic criteria for each test tool (table 5).

The second group (organizational criterion) includes the properties that characterize the tool for testing from a technical point of view:

Table 3

The results of assessment according to the functional-didactic criterion Classtime

№	The number of points for the indicator №					
	1	2	3	4	5	6
1	3	1	3	2	3	2
2	3	0	3	3	3	2
3	3	0	3	3	3	2
4	3	1	3	3	3	2
5	3	0	3	2	3	1
6	3	1	3	2	3	1
7	3	1	3	3	3	2
8	3	0	3	3	3	2
9	3	1	3	3	3	1
10	3	0	3	2	3	2
11	3	1	3	2	3	1
12	3	1	2	2	3	2
average	3	0.58	2.92	2.5	3	1.6

Table 4

The results of assessment according to the functional-didactic criterion Quizizz

№	The number of points for the indicator №					
	1	2	3	4	5	6
1	3	3	3	2	3	3
2	3	3	3	3	3	2
3	3	3	3	3	3	3
4	3	3	3	3	3	2
5	3	3	3	2	3	3
6	3	3	3	2	3	3
7	3	3	3	3	3	3
8	3	3	3	3	3	2
9	3	3	3	3	3	3
10	3	3	3	2	3	2
11	3	3	3	2	3	3
12	3	3	3	3	3	3
average	3	3	3	2.58	3	2.66

- 1) the availability of a free version;
- 2) no need to install the program;
- 3) ease of use – characterizes the convenience and clarity of the interface for creating tests and their use;
- 4) the ability to test online and offline;
- 5) time limits, both for a single question and the whole test;
- 6) random order of questions/answer options;
- 7) instant demonstration of the correct answer to the respondent.

Table 5
Functional and didactic criterion and its selection indicators

Tools	The number of points for the indicator №						The manifestation of the criterion
	1	2	3	4	5	6	
Kahoot	1	0	2.42	0.5	2.92	3	50%
Classtime	3	0.58	2.92	2.5	3	1.6	83%
Quizizz	3	3	3	2.58	3	2.66	100%

The results of the intermediate data of the expert survey by organizational criteria are presented in the tables 6, 7 and 8.

Table 6
Results of the evaluation of the organizational criterion for Kahoot!

№	The number of points for the indicator №						
	1	2	3	4	5	6	7
1	3	3	2	3	3	3	3
2	3	3	1	2	3	3	3
3	3	3	1	2	3	3	3
4	3	3	1	3	3	3	3
5	3	3	2	3	3	3	3
6	3	3	2	3	3	2	3
7	3	3	2	2	3	3	3
8	3	3	2	2	3	3	3
9	3	3	2	2	3	3	3
10	3	3	2	3	3	3	3
11	3	3	1	2	3	3	3
12	3	3	2	3	3	3	3
average	3	3	1.7	2.5	3	2.92	3

Let us highlight the results of the organizational criterion for each test tool (table 9).

We present a final table of the results of the manifestation of all criteria for the selected test programs (table 10).

4. Conclusions

For the study, the method of expert evaluation was applied, which consisted of two stages: the first surveyed experts to select online tools for creating tests; the second identifies an online means of creating tests, which took place using certain selection criteria and indicators.

As a result, the following criteria and relevant indicators for the selection of such online test creation tools are identified:

- functional-didactic: the presence of different types of questions, including open-ended; use of formulas, both in questions and in answers; use of pictures, both in questions and in answers; no restrictions on the length of questions and answers; instant receipt

Table 7

Results of the evaluation of the organizational criterion for Classtime

№	The number of points for the indicator №						
	1	2	3	4	5	6	7
1	3	3	2	3	1	3	3
2	3	3	2	3	0	3	3
3	3	3	2	2	1	3	3
4	3	3	2	3	1	3	3
5	3	3	2	3	0	3	3
6	3	3	2	3	0	3	3
7	3	3	2	3	0	3	3
8	3	3	2	3	0	3	3
9	3	3	3	3	0	3	3
10	3	3	3	3	1	3	3
11	3	3	3	3	0	3	3
12	3	3	2	3	0	3	3
average	3	3	2.25	2.92	0.33	3	3

Table 8

Results of the evaluation of the organizational criterion for Quizizz

№	The number of points for the indicator №						
	1	2	3	4	5	6	7
1	3	3	3	3	3	3	3
2	3	3	3	3	3	3	3
3	3	3	3	3	3	3	3
4	3	3	3	3	3	3	3
5	3	3	3	3	3	3	3
6	3	3	3	3	3	3	3
7	3	3	2	3	3	3	3
8	3	3	3	3	3	3	3
9	3	3	3	3	3	3	3
10	3	3	3	3	3	3	3
11	3	3	3	3	3	3	3
12	3	3	3	3	3	3	3
average	3	3	2.92	3	3	3	3

of results by the teacher, their evaluation and analysis; instant receipt of results by the respondent;

- organizational: free version; no need to install the program; ease of use – characterizes the convenience and clarity of the interface for creating tests and their use; possibility of testing in online and offline mode; time limits, both for a single question and the whole test; random order of questions/answer options; instant demonstration of the correct answer to the respondent. As a result of the elaboration of the method of expert assessment, it was found that the most appropriate online means of creating tests when

Table 9
Organizational criterion and its indicators

Tools	The number of points for the indicator №							The manifestation of the criterion
	1	2	3	4	5	6	7	
Kahoot!	3	3	1.7	2.5	3	2.92	3	100%
Classtime	3	3	2.25	2.92	0.33	3	3	87.5%
Quizizz	3	3	2.92	3	3	3	3	100%

Table 10
Results of the manifestation of all criteria in selected test programs

Tools	Criterion	
	Functional-didactic	Organizational
Kahoot	50%	100%
Classtime	83%	87,5%
Quizizz	100%	100%

teaching mathematics is Quizizz.

A promising area of further research is to develop a methodology for using this online tool to create tests for testing in the study of mathematics, as well as to develop a system of tests for each lesson, where at any stage you can include a test to understand whether learners have mastered this the question of whether they are ready for class, etc.

References

- [1] M. Velykodna, Psychoanalysis during the COVID-19 pandemic: Several reflections on countertransference, *Psychodynamic Practice* 27 (2021) 10–28. doi:10.1080/14753634.2020.1863251.
- [2] S. Semerikov, H. Kucherova, V. Los, D. Ocheretin, Neural network analytics and forecasting the country's business climate in conditions of the coronavirus disease (COVID-19), *CEUR Workshop Proceedings* 2845 (2021) 22–32. URL: http://ceur-ws.org/Vol-2845/Paper_3.pdf.
- [3] A. Bielinskyi, I. Khvostina, A. Mamanazarov, A. Matviychuk, S. Semerikov, O. Serdyuk, V. Solovieva, V. Soloviev, Predictors of oil shocks. Econophysical approach in environmental science, *IOP Conference Series: Earth and Environmental Science* 628 (2021) 012019. doi:10.1088/1755-1315/628/1/012019.
- [4] V. N. Soloviev, A. O. Bielinskyi, N. A. Kharadzjan, Coverage of the coronavirus pandemic through entropy measures, *CEUR Workshop Proceedings* 2832 (2020) 24–42. URL: <http://ceur-ws.org/Vol-2832/paper02.pdf>.
- [5] A. Kiv, P. Hryhoruk, I. Khvostina, V. Solovieva, V. Soloviev, S. Semerikov, Machine learning of emerging markets in pandemic times, *CEUR Workshop Proceedings* 2713 (2020) 1–20.
- [6] S. Semerikov, S. Chukharev, S. Sakhno, A. Striuk, V. Osadchyi, V. Solovieva, T. Vakaliuk,

- P. Nechypurenko, O. Bondarenko, H. Danylchuk, Our sustainable coronavirus future, E3S Web of Conferences 166 (2020) 00001. doi:10.1051/e3sconf/202016600001.
- [7] V. Tkachuk, Y. Yechkalo, S. Semerikov, M. Kislova, Y. Hladyr, Using Mobile ICT for On-line Learning During COVID-19 Lockdown, in: A. Bollin, V. Ermolayev, H. C. Mayr, M. Nikitchenko, A. Spivakovsky, M. Tkachuk, V. Yakovyna, G. Zholtkevych (Eds.), Information and Communication Technologies in Education, Research, and Industrial Applications, Springer International Publishing, Cham, 2021, pp. 46–67.
- [8] N. S. Ponomareva, Role and place of informatics in the training of future teachers of mathematics, Journal of Physics: Conference Series 1840 (2021) 012035. doi:10.1088/1742-6596/1840/1/012035.
- [9] O. Burov, A. Kiv, S. Semerikov, A. Striuk, M. Striuk, L. Kolgatina, I. Oliinyk, AREdu 2020 - How augmented reality helps during the coronavirus pandemic, CEUR Workshop Proceedings 2731 (2020) 1–46.
- [10] M. Syvyi, O. Mazbayev, O. Varakuta, N. Panteleeva, O. Bondarenko, Distance learning as innovation technology of school geographical education, CEUR Workshop Proceedings 2731 (2020) 369–382.
- [11] K. Polhun, T. Kramarenko, M. Maloivan, A. Tomilina, Shift from blended learning to distance one during the lockdown period using Moodle: test control of students' academic achievement and analysis of its results, Journal of Physics: Conference Series 1840 (2021) 012053. doi:10.1088/1742-6596/1840/1/012053.
- [12] I. S. Mintii, T. A. Vakaliuk, S. M. Ivanova, O. A. Chernysh, S. M. Hryshchenko, S. O. Semerikov, Current state and prospects of distance learning development in Ukraine, CEUR Workshop Proceedings (2021).
- [13] Decree of the Ministry of Education and Science of Ukraine from 08.09.2020 No. 1115 "Some issues of the organization of distance learning", 1969. URL: <https://zakon.rada.gov.ua/laws/show/z0566-11#Text>.
- [14] S. Kvit, O. Yeremenko (Eds.), Richnyi zvit Natsionalnoho ahentstva iz zabezpechennia yakosti vyshchoi osvity (Annual report of the National Agency for Quality Assurance in Higher Education), Natsionalne ahentstvo iz zabezpechennia yakosti vyshchoi osvity, Kyiv, 2021.
- [15] Decree of the Ministry of Education and Science, Youth and Sports of Ukraine of 13.04.2011 No. 329 "About the statement of Criteria of an assessment of educational achievements of pupils in general secondary education system", 1969. URL: <https://zakon.rada.gov.ua/laws/show/z0566-11#Text>.
- [16] K. Vlasenko, I. Lovianova, O. Chumak, I. Sitak, V. Achkan, The arrangement of on-line training of master students, majoring in mathematics for internship in technical universities, Journal of Physics: Conference Series 1840 (2021). doi:10.1088/1742-6596/1840/1/012007.
- [17] K. Vlasenko, D. Kovalenko, O. Chumak, I. Lovianova, S. Volkov, Minimalism in designing user interface of the online platform "Higher school mathematics teacher", CEUR Workshop Proceedings 2732 (2020) 1028–1043.
- [18] K. Vlasenko, S. Volkov, I. Sitak, I. Lovianova, D. Bobyliev, Usability analysis of on-line educational courses on the platform "Higher school mathematics teacher", E3S Web of Conferences 166 (2020). doi:10.1051/e3sconf/202016610012.

- [19] M. Zhaldak, V. Franchuk, N. Franchuk, Some applications of cloud technologies in mathematical calculations, *Journal of Physics: Conference Series* 1840 (2021). doi:10.1088/1742-6596/1840/1/012001.
- [20] T. Kramarenko, O. Pylypenko, I. Muzyka, Application of GeoGebra in Stereometry teaching, *CEUR Workshop Proceedings* 2643 (2020) 705–718.
- [21] T. Kramarenko, K. Bondar, O. Shestopalova, The ICT usage in teaching mathematics to students with special educational needs, *Journal of Physics: Conference Series* 1840 (2021). doi:10.1088/1742-6596/1840/1/012009.
- [22] I. Lovianova, D. Bobyliev, A. Uchitel, Cloud calculations within the optional course Optimization Problems for 10th-11th graders, *CEUR Workshop Proceedings* 2433 (2019) 459–471.
- [23] M. Shyshkina, M. Marienko, The use of the cloud services to support the math teachers training, *CEUR Workshop Proceedings* 2643 (2020) 690–704.
- [24] D. Bobyliev, E. Vihrova, Problems and prospects of distance learning in teaching fundamental subjects to future mathematics teachers, *Journal of Physics: Conference Series* 1840 (2021). doi:10.1088/1742-6596/1840/1/012002.
- [25] M. The, T. Usagawa, Effectiveness of e-learning experience through online quizzes: A case study of Myanmar students, *International Journal of Emerging Technologies in Learning* 13 (2018) 157–176. doi:10.3991/ijet.v13i12.9114.
- [26] D. Smoline, Some problems of computer-aided testing and “interview-like tests”, *Computers and Education* 51 (2008) 743–756. doi:10.1016/j.compedu.2007.07.008.
- [27] M. Gangur, Automatic generation of mathematic tasks, in: *Proceedings of the WSEAS/IASME International Conference on Educational Technologies*, 2011, pp. 129–134.
- [28] S. Rakov, M. Mazorchuk, V. Dobriak, Data processing technologies for calculating prognostic validity of educational achievement tests, *CEUR Workshop Proceedings* 1844 (2017) 388–395.
- [29] R. Tarasenko, S. Amelina, A. Azaryan, Integrated testing system of information competence components of future translators, *CEUR Workshop Proceedings* 2643 (2020) 376–391.
- [30] N. Shapovalova, O. Rybalchenko, I. Dotsenko, S. Bilashenko, A. Striuk, L. Saitgareev, Adaptive testing model as the method of quality knowledge control individualizing, *CEUR Workshop Proceedings* 2393 (2019) 984–999.
- [31] A. Mreła, O. Sokolov, Rankings of students based on experts’ assessment of levels of verification of learning outcomes by test items, *CEUR Workshop Proceedings* 1844 (2017) 289–302.
- [32] A. Abdula, H. Baluta, N. Kozachenko, D. Kassim, Peculiarities of using of the Moodle test tools in philosophy teaching, *CEUR Workshop Proceedings* 2643 (2020) 306–320.
- [33] I. Mintii, S. Shokaliuk, T. Vakaliuk, M. Mintii, V. Soloviev, Import test questions into Moodle LMS, *CEUR Workshop Proceedings* 2433 (2019) 529–540.
- [34] M. Lvov, H. Shmarova, Generation of test tasks in systems of computer mathematics for educational purposes, *CEUR Workshop Proceedings* 1844 (2017) 380–387.
- [35] N. Jiemsak, R. Jiemsak, The effectiveness of the quizizz interactive quiz media as an online self-assessment of undergraduate students to improve students’ learning outcomes, in: *2020 5th International STEM Education Conference, iSTEM-Ed 2020*, Institute of Electrical and Electronics Engineers Inc., 2020, pp. 51–54. doi:10.1109/iSTEM-Ed50324.2020.9332675.

- [36] Y. Chaiyo, R. Nokham, The effect of Kahoot, Quizizz and Google Forms on the student's perception in the classrooms response system, in: 2017 International Conference on Digital Arts, Media and Technology (ICDAMT), 2017, pp. 178–182. doi:10.1109/ICDAMT.2017.7904957.
- [37] J. Anderson, Frequent Feedback through Google Forms, PRIMUS 29 (2019) 124–137. doi:10.1080/10511970.2017.1411408.
- [38] C. Popescu, L. Avram, Good practices for online extended assessment in project management, Intelligent Systems Reference Library 199 (2021) 117–142. doi:10.1007/978-981-15-9908-8_5.
- [39] J. McConnel, “Why are we doing this?”: Using digital reflection to increase student engagement, Ubiquitous Learning 11 (2018) 13–22. doi:10.18848/1835-9795/CGP/v11i02/13-22.
- [40] G. Aras, B. Çiftçi, Comparison of the effect of reinforcement with question-answer and kahoot method on the success and motivation levels of nursing students: A quasi-experimental review, Nurse Education Today 102 (2021). doi:10.1016/j.nedt.2021.104930.
- [41] B. Pereira de Sousa, Engaging students in the evaluation process using co-creation and technology enhanced learning (CC-TEL), CEUR Workshop Proceedings 2190 (2018).
- [42] A. Domínguez, L. De-Marcos, J.-J. Martínez-Herráiz, Effects of competitive and cooperative classroom response systems on quiz performance and programming skills in a video game programming course, in: Annual Conference on Innovation and Technology in Computer Science Education, ITiCSE, Association for Computing Machinery, 2020, pp. 398–403. doi:10.1145/3341525.3387393.
- [43] A. Wildgoose, S. Bakrania, Development and implementation of rapid feedback using a cloud-based assessment tool, in: Proceedings - Frontiers in Education Conference, FIE, volume 2017-October, 2017, pp. 1–6. doi:10.1109/FIE.2017.8190602.
- [44] J. Nielsen, Usability engineering, Academic Press, New York, 1993.
- [45] O. M. Spirin, T. A. Vakaliuk, Criteria of open web-operated technologies of teaching the fundamentals of programs of future teachers of informatics, Information Technologies and Learning Tools 60 (2017) 275–287.
- [46] T. A. Vakaliuk, Criteria for selecting a cloud-based learning support system as a part of cloud-based learning environment for bachelor's degree in computer science, Zhytomyr Ivan Franko State University Journal (2017) 27–32.
- [47] Kahoot, 1998. URL: <https://kahoot.com/>.
- [48] Classtime, 1997. URL: <https://www.classtime.com/uk/>.
- [49] Quizizz, 2015. URL: <https://quizizz.com/>.

Gamification when studying logical operators on the Minecraft EDU platform

Elena G. Fedorenko¹, Nataliia V. Kaidan¹, Vladyslav Ye. Velychko¹ and Vladimir N. Soloviev²

¹Donbass State Pedagogical University, 19 Henerala Batiuka Str., Sloviansk, 64122, Ukraine

²Kryvyi Rih State Pedagogical University, 54 Gagarin Ave., Kryvyi Rih, 50086, Ukraine

Abstract

Use of visual methods plays a significant role in learning. ICT allow us to create electronic educational resources in a new format and with new opportunities. The study of their didactic possibilities, forms and methods of their application is a topical issue. Simulation, virtualization, gamification requires new knowledge about their application, and therefore, the problem of training future teachers to use them is an urgent and important part of training. In this article modern achievements in the use of serious games in education were investigated and analyzed, the possibilities of using virtual worlds in education were considered, the recommendations for the practical training of future teachers to use them were developed. In practice, the effectiveness of the use of virtual tools in education has been tested. A pedagogical experiment has been launched to identify the effectiveness of gamification in the realities of education in Ukraine.

Keywords

gamification, Minecraft EDU, professional training of pre-service teachers, logical operators

1. Introduction

On its Global Advisor platform in the fall of 2020, Ipsos conducted a survey of adults under the age of 75 from 29 countries and territories on their vision for the future of higher education, which was attended by more than 27,500 people [1]. Almost a quarter of the world's surveyed adults (23%) believe that in five years' higher education in their country will be provided entirely or mainly through Internet resources, technology, etc.; the majority of respondents (49%) believe that training will be divided in half and will take place in person and at the distance. The opinion that in the future higher education will be conducted mostly using Internet technologies is shared by 19% of respondents aged 50-74, 24% among people aged 35-49 and 25% among age groups 18-34. The introduction of e-education is impossible without the

AREdu 2021: 4th International Workshop on Augmented Reality in Education, May 11, 2021, Kryvyi Rih, Ukraine

✉ fedorenko.elena1209@gmail.com (E. G. Fedorenko); kaydannv@gmail.com (N. V. Kaidan);

vladislav.velichko@gmail.com (V. Ye. Velychko); vnsoloviev2016@gmail.com (V. N. Soloviev)

🌐 <https://scholar.google.com.ua/citations?user=9hVB6f8AAAAJ> (E. G. Fedorenko);

<https://scholar.google.com.ua/citations?user=qFFTl0UAAAAJ> (N. V. Kaidan); <https://ddpu.edu.ua/cc/velychko/>

(V. Ye. Velychko); <https://kdpu.edu.ua/personal/vmsoloviov.html> (V. N. Soloviev)

🆔 0000-0002-1897-874X (E. G. Fedorenko); 0000-0002-4184-8230 (N. V. Kaidan); 0000-0001-9752-0907

(V. Ye. Velychko); 0000-0002-4945-202X (V. N. Soloviev)

© 2021 Copyright for this paper by its authors.

Use permitted under Creative Commons License Attribution 4.0 International (CC BY 4.0).

 CEUR Workshop Proceedings (CEUR-WS.org)

availability of special tools. The part of Internet resources such as digital electronic resources is a learning tool. The role of digital electronic resources in educational activities is constantly growing, and respectively, new types of them appear, or existing ones become popular due to the development of information and communication technologies.

For many years in a row, teachers have been using videos in the classroom to visualize the theoretical part of the new material. At the moment, the technology of the inverted (“flipped”) class is becoming very popular [2]. This technology is not possible without the use of video-based learning information. However, the increasing of the level of learning with the help of electronic educational resources based on the use of videos in the genre of “Let’s Plays” is almost not noticed. Note that unlike previous generations of students who interacted with websites, blogs, and social media-based learning channels, the current generation learns more through YouTube Let’s Plays and Twitch-based video streams [3]. Today’s younger generation makes little use of books, web pages, or any of the technologies traditionally used by adults. The formation of a new format of digital literacy is necessary for the participation of modern youth in these, mainly, special learning environments. First of all, it is the ability to record and edit video, “capture” and broadcast gameplay and other actions on the screen, a high level of technical communication and the ability to inform and teach others by performing complex tasks.

2. Research methods

In the process of research, we used search and system methods, methods of analysis, comparison, generalization, the studying of scientific approaches to selected issues. A comprehensive study of the gamification of the educational process provided a systematic method and the study of scientific approaches to selected issues. The method of analysis was used for systematization, analysis of data and information on the researched problems.

3. Results of the research

Video games for education are currently a significant segment of educational content. Digital game-based learning is becoming increasingly popular. The study by Tokac et al. [4] presents the effectiveness of teaching mathematics based on video games. In their work, researchers claim that video games help to increase mathematical knowledge compared to traditional. Wouters et al. [5] examines in detail the impact of “serious games” on learning. Authors proved that those who learn serious games learned more than those who learned the usual teaching methods. Opinions of scientists on the use of games in education differ. One part argues that for digital game-based learning to succeed, you need to have the “right” learning games [6, 7, 8, 9, 10, 11, 12]. Another is convinced that teachers should take an active role in the development of educational activities through digital games [13, 14]. Teachers should adapt digital games as part of their learning toolkit.

The study of Chen et al. [15] analyzed the effect of competition in digital gaming learning. According to the data obtained during the study, competition in digital game-based learning (DGBL) was effective for mathematics, science and language. It was effective for college students.

Most of the effect was seen in solving puzzle, strategy, role-playing, and simulation games, but not for action games. As a result, it was found that competition in DGBL was equally effective for cognitive and non-cognitive outcomes.

Similar research results on the application of games in mathematical education K-12 were produced by Byun and Joung [16]. This paper, first, investigates the current trend of digital game-based learning by analyzing exploratory research on the use of DGBL to study mathematics and achievements in the study of mathematics. Secondly, the future directions of DGBL research in the context of teaching mathematics are indicated. Researchers analyzed 296 studies, of which only 33 studies were identified as empirical and systematically analyzed to study current trends. In addition, due to the lack of statistics, only 17 of the 33 selected studies were analyzed to calculate the overall effect of digital games on math education.

A similar study was conducted by Clark et al. [17]. The authors analyzed the published results of research on the overall effect of digital games on learning outcomes from 2000 to 2012. They came to the attention of 1,040 works, of which only 69 had information on unique empirical studies of the use of digital electronic games in education. 6869 respondents were involved in the selected studies. As a result, researchers have concluded that games as an environment certainly provide new and powerful opportunities, but it is active creative activity in the game environment that determines the effectiveness of the learning environment.

Gunter et al. [18] analyzed the RETAIN (Relevance, Transfer, Adaptation, Immersion, Naturalization) model, which is based on the following positions: relevance is the relevance of materials to students' needs; consistency – the need to submit academic content in accordance with the game plot; integration based on the existing experience of students in other areas, as well as the possibility of applying in real life the acquired knowledge; adaptation – change of behavior due to integration from the virtual to the real world; immersion – intellectual involvement in the game; implementation of skills acquired in the game and their application in real life.

In addition to these issues, no less important is the relationship between game, pedagogical, and realistic components in serious games. Harteveld [19] emphasizes that the attributes of a serious game are: pedagogy, low saturation of resources, step-by-step process, harmony, experience, uncertainty, research, game elements, attributes, interactivity, involvement, learning goal, target groups, organization, reality and challenge. Pedagogy proclaims the need for reflection, but the game, ideally, encourages it. Learning in action brings the highest results, which means that students should not just read the text, but live the learning process internally. The low level of information saturation of resources provides an opportunity for children to develop the ability to draw independent conclusions and make decisions.

An important issue is also the effectiveness of digital game-based learning (DGBL). There is a heterogeneity in the methods of assessing the effectiveness of DGBL, which leads to differences in determining the reliability and validity of certain methods. All et al. [20] explored a variety of methods for assessing the effectiveness of learning, identified by experts in psychology and pedagogy through semi-structured interviews to identify desirable methods for conducting research on the effectiveness of DGBL. Their proposed improvements in the methodology for determining the level of effectiveness relate to the implementation of the intervention in both the experimental and control groups. The participants themselves determine which elements are desirable to omit during the intervention (e.g., instructor guidance, additional elements consisting of essential information), and which elements will be important (e.g. procedural

assistance, training). The researchers identified the parameters by which the similarity between the experimental and control conditions should be achieved (e.g., time of intervention, instructor, day of the week). As for the measurement of methods, the proposed improvements relate to the immersion of participants in the conditions (e.g. parameters to be considered when using blocked randomized design), the general design (e.g. the need for preliminary testing and control group), test development (e.g. develop and pilot parallel tests) and testing (for example, follow-up after a minimum of 2 weeks of training).

Gamification is the use of individual elements of games in non-gaming practices [21, 22]. Tekinbaş and Zimmerman [23] define a game as a system in which players are involved in resolving an artificial conflict that is determined by rules and has a quantitative result. Gamification differs from other game formats in that its participants are focused on the goal of their real activity, and not on the game as such. Game elements are integrated into real situations to motivate specific forms of behavior in given conditions.

Game techniques have always been used in school education. Tests and exams, the transition from class to class, final testing – there are elements of the game, but not always effective. The problem is that classical educational methods often ignore the simple but infinitely important fact – learning should bring joy and satisfaction, should be interesting. It is known that the human brain is set on the positive, that is, when instead of fighting boredom there is a drive and positive emotions, the information is absorbed better.

The main attraction of game techniques is the attitude to mistakes. At school, teachers always focus on mistakes, but rarely praise the right answers or decisions. Fixation on mistakes leads to the fact that students focus more on grades than on knowledge. In computer games, on the other hand, mistakes are welcomed and are the main tool for success. Take the game Angry Birds, which at least once played all modern children. It clearly demonstrates how with each failure the player experiences new options for successfully achieving the goal – to defeat the pigs. When we play, we know that there is nothing wrong with failure - the sooner we do something wrong, the sooner we can find the right solution. Game is one of the ways of motivation, development of logical thinking, but not a universal undisputed means. Gamification will not work without quality educational content.

For the learning process to be called gamified, it must contain 4 characteristics that McGonigal [24] highlighted in her TED talk:

- clearly defined goals that provide motivation to participate in the game;
- logical and consistent rules that set limits and frameworks for achieving goals;
- a stable feedback system that ensures that goals are achievable and players follow the rules;
- voluntary consent to learn the game and follow the rules of achieving the goal.

Werbach and Hunter [25] note the motivational function of gamification. They believe that gamification allows to intensify human learning. In addition, gamification allows not only to create new games, but also to use their components for motivation. According to them, any component of the game can be used outside the format of the game – to form a person's involvement in a particular environment.

One of the games that has become very popular among children and teachers is Minecraft (<https://www.minecraft.net/>). Minecraft is a virtual community where players can roam freely and interact with the world made from blocks. Since its release in 2011, the game has become a cultural phenomenon. More than 200 million units were sold worldwide (as of May 2020) [26]. Due to this success, a special version for learning Minecraft: Education Edition (Minecraft EDU, <https://education.minecraft.net/>) was released.

The educational and game process with the help of Minecraft EDU is built on the following structure: the teacher controls the virtual map where his students play; the teacher can integrate the necessary lessons and tasks into this card. In order for teachers not to do unnecessary work, the game offers a rich library of previously created “worlds”, as well as the development of previously created lessons. The learning worlds of Minecraft EDU provide ample opportunities. For example, find the perimeter of an area or distinguish the remains of a dinosaur from other minerals. The teacher gives each student access to buildings, areas on a virtual map, thus correcting his actions. This makes it possible to teach many individuals at the same time.

Tools such as cameras and portfolios have been added to the game for educational institutions. With their help, students take pictures, record progress. Innovations for teachers were created taking into account the real experience of teachers who used the game in their lessons. Colleagues-innovators have introduced elements such as blackboards for instructions and additional tasks. Teleport for quick movement on the map, the ability to track the location of students, settings to adjust the cycle of day and night or the complexity of the game. Blackboards are interesting elements of the game. These boards have three different sizes on which you can place tasks for students. Class mode allows the teacher to see the general picture of students’ activities.

Due to its flexibility, the game easily adapts to different subjects. Those who decided to try Minecraft EDU in their classes could be advised:

1. Before the game, discuss with students the rules of behavior in the virtual world. No one will like it if a classmate destroys a copy of the Arc de Triomphe, which you worked on for several lessons.
2. Make sure that your world is set up for the task of the lesson, before running students in it. For very busy teachers, Minecraft EDU offers ready-made starter kits for basic school subjects (<https://education.minecraft.net/class-resources/lessons/>).
3. Make a paper copy of the instructions, tasks, questions, or tips for students. This will help them focus on the task at hand.
4. Take time for the introductory lesson to show children the basics of the game process: click the menu, perform the basic actions. It is best to combine novice players with experienced ones to facilitate learning. It is important to remember that this is just a game that helps us perform certain tasks. Combine the usual educational environment - books, textbooks with the Minecraft environment.
5. Take a break every half hour. At this time, invite students to share with the class their achievements or difficulties, as well as their impressions.

Consider some of the existing worlds of Minecraft EDU that can be used by teachers of various school subjects. The first world is called Tutorial-world and is a guide to the world of

Minecraft. The world of *Fantastic-mr-fox* is the fairy-tale world of Mr. Fox, who gave us the idea of creating his own fairy-tale world. A geography teacher will like worlds with biomes such as savannah, mountains, taiga and ocean, such as the world of *secret-reef*. The world of *project-storytelling* offers its own version of training that will be useful for teachers of literature and Ukrainian language. For biology teachers, there is a lesson on studying the life of elephants and their protection, which is called *watr-humans-and-elephants*. An interesting lesson *lesson-hub-volume-i*, the author of which wrote that in this world there is a collection of educational activities where you can study fractions or study the history of the United States in the middle of the 20th century. Physics teachers will be interested to learn about the properties of Redstone in the worlds of *redstone-breakout* and *redstone-lodge*. In this learning and virtual world, you can create traps, automated farms for growing and harvesting and much more. The world of chemistry and chemistry lessons will be useful for chemistry teachers. In these worlds there is a large table of chemical elements of Mendeleev. Children are happy to learn the process of creating balloons. Computer science teachers will be interested in programming lessons *trainings/code-builder-for-minecraft-education-edition*. In this game you need to use Code connection and be able to work with Scratch, CodeMake, Tynker, which is still engaged in 3D modeling and allows you to move the created objects into the world of Minecraft.

The interesting thing in Minecraft is a resource called Redstone, which you can use to create logic circuits. In this way, the player can make their buildings interactive. Circuits created from Redstone transfer energy from one Unit to another like electrical circuits, and a torch is needed to supply energy to the circuit. If you install levers, buttons and other controls and use them, the player will be able to switch the chain from one position to another.

Minecraft allows players to create logic gates that perform simple logic operations. For example, with the help of two levers, you can create a valve “AND”, which passes “energy” through the chain only when both levers are activated, or a valve “OR”, which passes “energy”, if either of the two was activated levers. This system simulates the device of real electronics and Boolean logic, which allows you to create complex mechanisms. Thanks to this feature, the game can serve as a virtual constructor for programmers and engineers.

The teacher can use not only ready-made lessons, but also create their own. We explored a virtual learning environment created by Minecraft EDU and its practical application on the example of the topic “Logical Operators”. This topic is considered during the study of the subject “Computer Science” (Grade 8) and is related to such issues as the basics of algorithmization and programming, processing and storage of information. Not only paper sources of information, but also working digital models are necessary for the better understanding of a training material. Implementing such models on the basis of real mechanisms or electromagnetic devices is quite difficult and inefficient, because students, for the most part, will not be able to understand the existing analogies. In this case, it is best to use a virtual learning environment, which is in fact a virtual world where most modern children feel “at home”.

Despite the large number of studies on gamification, this educational trend has not chosen its primacy in the education system of Ukraine, as evidenced by a study conducted under the MoPED project [27]. Only 7.5% of lecturers, 18.6% of students and 15% of teachers attributed gamification to the selected three important educational trends. The reasons for this result are the weak technical base of universities, partial awareness of the teaching staff in the field of information and communication, English language used by most of Internet platforms, lack of

methodological developments in the use of gamification, lack of financial resources for paid subscriptions.

This problem can be partially solved by preparing future teachers for the use of gamification technology in the educational process of the school within the university educational programs. Preparing future teachers for the use of serious games should be a process that has a purposeful, planned, multilevel, multi-stage nature with organized interaction of all participants in the educational process and aimed at mastering the knowledge and skills of serious games in educational activities with constant monitoring of results. This makes it possible to argue about the need to include in the professional training of future teacher's disciplines aimed at acquiring knowledge and skills in the field of application of gamification in the educational activities of students.

Educational training programs for future teachers of mathematics, physics and computer science do not contain educational components that form competencies in the use of serious games in professional activities. However, elements of such training should be included in the educational components, taking into account the sectoral focus of training. Our research topic "Logical Operators" is related to such educational components as mathematical logic, algorithm theory, discrete mathematics, programming, teaching methods, etc. The inclusion of elements of gamification in the above educational components will lay the foundation for further application of gamification in professional activities. To do this, you must use any opportunity. In our opinion, such opportunities include:

- visual materials for lectures (screenshots made in the game environment or on its background, product placement);
- practical tasks with elements of gamification (involve full or partial involvement of serious games);
- independent work performed in game environments (additional points for use in the process of playing games);
- laboratory work on teaching methods (results are aimed at creating educational content and take into account the desire of students to use games).

Particular attention should be paid to the training of future teachers regarding the knowledge and skills of using serious digital games in education in the discipline of Methodology of teaching in the fields of knowledge. It is necessary not only in theory but also in practice to study the stages of organization of educational activities on the basis of serious games, namely:

- determine the target audience of educational content;
- set a learning goal;
- create a structure of educational content;
- determine which elements can be gamified;
- implement the selected elements through a digital game;
- apply the developed educational content;
- perform current and final control over the educational process;
- perform an analysis of the results.

When studying in a higher education institution, future teachers need to be prepared for the use of serious games based on the advantages and disadvantages of gamification. The advantages include: the ability to use distance learning (individually and collectively); the ability to use a variety of multimedia tools and modern technologies; strengthening the creative abilities of the individual, the development of creative thinking, self-organization, self-control and self-discipline; less study load, increased independence in learning and self-development; increasing interest in learning through interesting presentation of the material, which increases the degree of assimilation of the material. The disadvantages of gamification are: the lack of communication during training; the probability of incorrect conclusions; increase the amount of time a person will spend on the screen; possible technical failures in work; the need for special training of teachers and some time to master new technologies; spending a significant amount of time on the development and implementation of game technologies; high financial and time costs.

At the beginning of our study, a survey was developed and conducted among 4th year students of the State Higher Educational Institution “Donbass State Pedagogical University” who study in the educational programs of secondary education (mathematics), secondary education (physics), secondary education (computer science) or their combination with other educational programs. Respondents were asked the following questions:

1. Do you know the concept of gamification? (Yes/No)
2. What do you feel about learning through play? (Positive/Negative)
3. What do you feel about restricting the use of mobile devices in schools? (Support/Disapprove)
4. Have you had any experience learning through a computer game? (Yes/No)
5. Are you ready to learn to use games in educational activities? (Yes/No)

67 students took part in the survey. The results of their answers are presented in table 1.

Table 1

The results of answers during the survey

Question	Yes/Positive/Support	No/Negative/Disapprove
Q1	25	42
Q2	58	9
Q3	12	55
Q4	26	41
Q5	64	3

The results show that most students are not familiar with the concept of “gamification”, although they are ready to learn by playing. Most respondents are willing to learn and support new forms and means of learning and do not understand the restrictions on the use of mobile devices that can be useful in educational activities.

As noted in the theoretical part of our study, we introduced elements of gamification in the disciplines of teaching methods. Laboratory tasks on development of educational scenarios of studying of a theme “Logical operators” in the Minecraft EDU environment were offered. As a

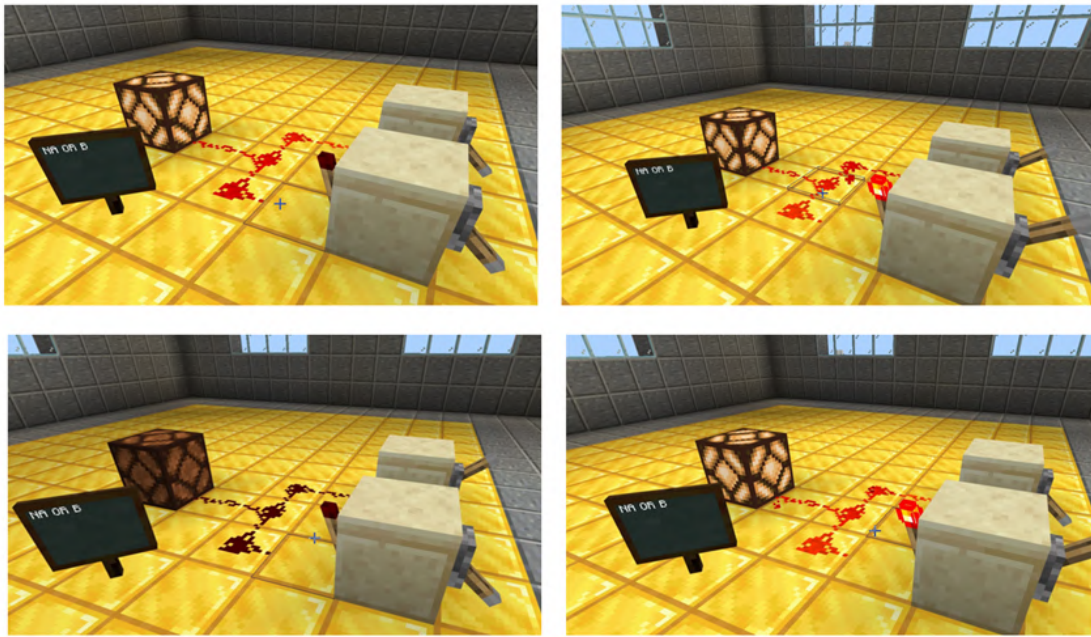

Figure 1: Example of the created world in Minecraft EDU.

result of the group project, several educational tasks were created, and their approbation took place during the internship of students in educational institutions (see figure 1).

Students' reports on internships and their own observations showed considerable interest in the proposed tasks. Despite the fact that the topic "Logical expressions. Variables of logical type. Logical operations" in the 8th grade belongs to the section "Programming" and is usually difficult to understand, the material was studied at a high level. This is evidenced by the fact that the further use of knowledge gained during the study of the topic "Logical expressions. Variables of logical type. Logical operations" in such topics as "Algorithms with branching" and "Cyclic algorithms" did not cause any difficulties in mastering these new topics. In addition, the homework, which students usually do without enthusiasm, was done perfectly and absolutely by all students without exception (boys, girls), which indicates an interest in the presented learning tool. A survey of students found that about 18% of 8th graders have active accounts in Minecraft and participate in joint game sessions. This percentage did not significantly affect the performance of the tasks. Kids who already have accounts in Minecraft coped with tasks faster than their peers.

4. Conclusions

The challenges that occur in real life require the parallel processing of vital data by several cognitive systems. In this regard, the traditional subject approach does not always adequately prepare students to solve problems. The developers of Minecraft EDU offer an optimal platform

for interdisciplinary learning, simulating a complex, multifaceted world in the information and educational space. Every teacher should understand the importance of creating “their own product” as a result of student activity in the classroom. This creative process involves the formation of a sense of confidence in their actions and aspirations in the design of future life, understanding the need for acquired knowledge and the importance of acquired skills and abilities. Children must learn to experiment and create their own product without fear of possible mistakes.

First of all, gamification should be used to form certain skills or behaviors, to visualize and emphasize such actions and skills that are difficult to demonstrate using traditional methods. Gamification is first and foremost a tool designed to improve the quality of education, to facilitate the assimilation of information, which can stimulate children to learn and which should attract rather than distract. This tool should be used in limited quantities. For the effectiveness of traditional forms of learning, it is necessary to gradually introduce this tool into the learning process.

Thus, we conclude that such a new form for Ukraine as gamification of the educational process is a promising tool for improving the quality of education. For successful gamification, you need to follow the basic stages of creating a game mechanism. It is important to gradually adapt teachers and students to the principles of gamification while studying in the Free Economic Zone. Consideration of methods of using digital game content, creating a library of digital electronic educational resources for further use is an all new field for research and development.

References

- [1] N. Boyon, Higher education is widely expected to move online, 2020. URL: <https://www.ipsos.com/en/global-views-person-vs-online-education>.
- [2] A. Abdula, H. Baluta, N. Kozachenko, D. Kassim, Peculiarities of using of the Moodle test tools in philosophy teaching, CEUR Workshop Proceedings 2643 (2020) 306–320.
- [3] O. Chorna, V. Hamaniuk, A. Uchitel, Use of YouTube on lessons of practical course of German language as the first and second language at the pedagogical university, CEUR Workshop Proceedings 2433 (2019) 294–307.
- [4] U. Tokac, E. Novak, C. G. Thompson, Effects of game-based learning on students’ mathematics achievement: A meta-analysis, *Journal of Computer Assisted Learning* 35 (2019) 407–420. doi:10.1111/jcal.12347.
- [5] P. Wouters, C. van Nimwegen, H. van Oostendorp, E. D. van der Spek, A meta-analysis of the cognitive and motivational effects of serious games, *Journal of Educational Psychology* 105 (2013) 249–265. doi:10.1037/a0031311.
- [6] O. Haranin, N. Moiseienko, Adaptive artificial intelligence in RPG-game on the Unity game engine, CEUR Workshop Proceedings 2292 (2018) 143–150.
- [7] O. Katsko, N. Moiseienko, Development computer games on the Unity game engine for research of elements of the cognitive thinking in the playing process, CEUR Workshop Proceedings 2292 (2018) 151–155.
- [8] D. S. Shepiliev, S. O. Semerikov, Y. V. Yechkalo, V. V. Tkachuk, O. M. Markova, Y. O. Modlo, I. S. Mintii, M. M. Mintii, T. V. Selivanova, N. K. Maksyshko, T. A. Vakaliuk, V. V.

- Osadchyi, R. O. Tarasenko, S. M. Amelina, A. E. Kiv, Development of career guidance quests using WebAR, *Journal of Physics: Conference Series* 1840 (2021) 012028. doi:10.1088/1742-6596/1840/1/012028.
- [9] V. Soloviev, N. Moiseienko, O. Tarasova, Complexity theory and dynamic characteristics of cognitive processes, *Communications in Computer and Information Science* 1175 CCIS (2020) 231–253. doi:10.1007/978-3-030-39459-2_11.
- [10] A. Tokarieva, N. Volkova, I. Harkusha, V. Soloviev, Educational digital games: Models and implementation, *CEUR Workshop Proceedings* 2433 (2019) 74–89.
- [11] T. Vakaliuk, V. Kontsedailo, D. Antoniuk, O. Korotun, I. Mintii, A. Pikilnyak, Using game simulator Software Inc in the Software Engineering education, *CEUR Workshop Proceedings* 2547 (2020) 66–80.
- [12] T. Vakaliuk, V. Kontsedailo, D. Antoniuk, O. Korotun, S. Semerikov, I. Mintii, Using Game Dev Tycoon to develop professional soft competencies for future engineers-programmers, *CEUR Workshop Proceedings* 2732 (2020) 808–822.
- [13] R. Cayatte, *Where Game, Play and Art Collide, Understanding Minecraft*, McFarland & Company, Inc., Jefferson, NC, 2014, pp. 203–214.
- [14] C. Gallagher (Ed.), *Minecraft in the Classroom: Ideas, inspiration, and student projects for teachers*, Peachpit Press, 2014.
- [15] C.-H. Chen, C.-C. Shih, V. Law, The effects of competition in digital game-based learning (DGBL): a meta-analysis, *Education Tech Research Development* 68 (2020) 1855–1873. doi:10.1007/s11423-020-09794-1.
- [16] J. H. Byun, E. Joung, Digital game-based learning for K–12 mathematics education: A meta-analysis, *School Science and Mathematics* 188 (2018). doi:10.1111/ssm.12271.
- [17] D. B. Clark, E. E. Tanner-Smith, S. S. Killingsworth, Digital games, design, and learning: A systematic review and meta-analysis, *Review of Educational Research* 86 (2016) 79–122. doi:10.3102/0034654315582065.
- [18] G. A. Gunter, R. F. Kenny, E. H. Vick, Taking educational games seriously: using the RETAIN model to design endogenous fantasy into standalone educational games, *Educational Technology Research and Development* 56 (2008) 511–537. doi:10.1007/s11423-007-9073-2.
- [19] C. Harteveld, *Triadic Game Design: Balancing Reality, Meaning and Play*, Hardcover, 2011.
- [20] A. All, E. P. N. Castellar, J. V. Looy, Assessing the effectiveness of digital game-based learning: Best practices, *Computers & Education* 92–93 (2016) 90–103. doi:10.1016/j.compedu.2015.10.007.
- [21] V. Buzko, A. Bonk, V. Tron, Implementation of gamification and elements of augmented reality during the binary lessons in a secondary school, *CEUR Workshop Proceedings* 2257 (2018) 53–60.
- [22] I. P. Varava, A. P. Bohinska, T. A. Vakaliuk, I. S. Mintii, Soft skills in software engineering technicians education, *Journal of Physics: Conference Series* 1946 (2021) 012012. doi:10.1088/1742-6596/1946/1/012012.
- [23] K. S. Tekinbaş, E. Zimmerman, *Rules of Play: Game design fundamentals*, MIT Press, 2004.
- [24] J. McGonigal, *Gaming can make a better world*, 2010. URL: https://www.ted.com/talks/jane_mcgonigal_gaming_can_make_a_better_world.
- [25] K. Werbach, D. Hunter, *For the win: How game thinking can revolutionize your business*,

Wharton digital press, 2012.

- [26] H. Chiang, Minecraft: Connecting more players than ever before, 2020. URL: <https://news.xbox.com/en-us/2020/05/18/minecraft-connecting-more-players-than-ever-before/>.
- [27] N. Morze, M. Gladun, V. Vember, O. Buinytska, S. Vasylenko, 3D mapping of Ukrainian Education System. Modernization of Pedagogical Higher Education by Innovative Teaching Instruments (MoPED) 586098-EPP-1-2017-1-UA-EPPKA2-CBHE-JP, 2018. URL: https://drive.google.com/file/d/1FXwfrUrTcPI0J3FI9-UGS94osH_yp14P/view.

Analysis of tools for the development of augmented reality technologies

Tetiana A. Vakaliuk^{1,2,3}, Svitlana I. Pochtoviuk⁴

¹Zhytomyr Polytechnic State University, 103 Chudnivsyka Str., Zhytomyr, 10005, Ukraine

²Kryvyi Rih State Pedagogical University, 54 Gagarin Ave., Kryvyi Rih, 50086, Ukraine

³Institute of Information Technologies and Learning Tools of the NAES of Ukraine, 9 M. Berlynskoho Str., Kyiv, 04060, Ukraine

⁴Kremenchuk Mykhailo Ostrogradsky National University, 20 Pershotravneva Str., Kremenchuk, 39600, Ukraine

Abstract

The article considers cross-platform products that should be used to develop augmented reality technologies: Unreal Development, Kit, Unity, Godot, Engine, Cocos2D, MonoGame, Unreal Engine, Marmalade, and others. Also, the possibilities of known SDKs for the development of augmented reality applications (Wikitude, Vuforia, Kudan, Maxst, Xzing, NyARToolkit, Metaio SDK) are given. It is established that for the development of augmented reality technologies can be used not only cross-platform engines but also sets of development tools. Such kits allow you to speed up and simplify the process of developing any program with elements of augmented reality. These advantages and disadvantages will help beginners to choose the most convenient tool for developing augmented reality technologies. In addition, the article attempts to identify criteria and indicators for the selection of such environments, as well as their expert evaluation.

Keywords

development tools, technologies, augmented reality, SDK

1. Introduction

Recently, scientists have been paying special attention to the use of augmented reality in various classes, both in general secondary education [1, 2] and in higher education [3, 4]. Therefore, the development of various augmented reality (AR) tools is also relevant. However, to develop any AR tool, it is need to make a choice of appropriate development tools.

In particular, Kiv et al. [5] explored the possibilities of transforming augmented reality into augmented education. Morkun et al. [6] considered augmented reality as a tool for visualization of ultrasound propagation in heterogeneous media based on the k-space method.

Chen et al. [7] conducted a review of augmented reality technology. In their article, they introduces the development tools, key technologies and application of AR in several field.

AREdu 2021: 4th International Workshop on Augmented Reality in Education, May 11, 2021, Kryvyi Rih, Ukraine

✉ tetianavakaliuk@gmail.com (T. A. Vakaliuk); svetlanapochtovyuk@gmail.com (S. I. Pochtoviuk)

🌐 <https://sites.google.com/view/neota/profile-vakaliuk-t> (T. A. Vakaliuk); <http://irbis-nbuv.gov.ua/ASUA/0055819> (S. I. Pochtoviuk)

🆔 0000-0001-6825-4697 (T. A. Vakaliuk); 0000-0002-0463-0072 (S. I. Pochtoviuk)

© 2021 Copyright for this paper by its authors.
Use permitted under Creative Commons License Attribution 4.0 International (CC BY 4.0).



CEUR Workshop Proceedings (CEUR-WS.org)

Some authors consider the possibility of developing augmented reality technologies. In particular, Kanivets et al. [8] investigated the development of mobile applications of augmented reality for projects with projection drawings, Bilous et al. [9] proposed the development of AR-applications as a promising area of research for students, and Hordiienko et al. [10] - the development of a model of the solar system in AR and 3D.

Others consider the possibility of using augmented reality technologies in education. Thus, Shyshkina and Marienko [11] studied augmented reality as a tool for open science platform by research collaboration in virtual teams; Iatsyshyn et al. [12] studied the possibilities of using the application of augmented reality technologies for the preparation of specialists of the new technological era; Midak et al. [13] considered augmented reality technology within studying natural subjects in primary school; Rashevska et al. [14] described the possibilities of using augmented reality tools in the teaching of two-dimensional plane geometry; Oleksiuk and Oleksiuk [15] investigated exploring the potential of augmented reality for teaching school computer science.

That is why the purpose of the article is to analyze the available tools to develop augmented reality technologies, in particular for the education sector.

2. Results

2.1. Overview of available tools for working with AR

At the moment, the choice of cross-platform products is small. Here are some of the most popular cross-platform engines on the market: Unreal Development Kit, Unity, Godot, Engine, Cocos2D, MonoGame, Marmalade, and others.

All these engines have good technical performance and support most mobile platforms. However, most developers make their choice based not only on the number of supported platforms but also on the ease of transferring code to different platforms, performance, and more.

Since you need a tool to create applications for phones with the Android operating system, several options have been selected.

Cocos2d is a framework for creating applications and games for iOS, Android, Windows Phone. The engine is completely free, there are many branches: Cocos2d-ObjC, Cocos2d-x, Cocos2d-html5, and Cocos2d-XNA. Most often Cocos2d is used to create games for iOS. The engine is highly adaptable, well suited for novice developers. In terms of performance, it beats Unity, but the design of the Cocos2d itself is worse than the competitor.

Unreal Engine 4 is a gaming engine created by Epic Games. Unreal Engine 4 is the most popular game engine for creating movies and AAA projects.

Godot Engine is free game engine, has a powerful visual scene editor, animation editor, its integrated development environment.

Unity is a gaming engine for developing 2D and 3D applications and games for various platforms [16, 17, 18]. Unity can be downloaded for free. This version will not be a demo version or for a while, you can use it to create your project. Only it is impossible to expose it paid in the market, it is necessary to put advertising in the application or game.

The Unity development environment is the most convenient for the software implementation of augmented reality technology. It is a high-level development environment for applications and games. Includes a powerful editor with a graphical interface and a graphical engine optimized for mobile devices.

Developer scripts can be written in any .NET programming language and compiled into regularly managed assemblies (DLLs). There are built-in compilers for C#, UnityScript, and Boo. At the same time, there is a possibility of the organization of the interface with the external code. The advantages also include an active community of developers and many ready-made developments and extensions.

Here are the main criteria by which to describe Unity as a modern gaming engine with rich potential and ample opportunities (see table 1) [19].

Table 1
The main characteristics of Unity

Indicator	Characteristic
Sound	Own audio plug-ins, the ability to use third-party audio plug-ins; call animation scripts – create keyframes in the animation editor and link scripts to them; sound mood changes, call animation scripts – create keyframes in the animation editor and link scripts to them; ability to change sound settings.
Graphics	A way of representing objects that do not have clear geometric boundaries (smoke, vapors, liquids, etc.); ability to place images from the camera not on the screen, but in the texture, needed to create some effects; built-in sprite editor can automatically cut a raster with sprites into frames and create animation from them. Link events to specific animation keyframes; use of various types of compression of textures and packing of the used frames of sprites in one resource; built-in Box2D library, and support for NVIDIA PhysX (physics implemented through use in GPU calculations); alphabet, cropping part of the image on the mask, which is placed in the alpha component of the texture; super-accurate collision detection; dynamic Batching, a rendering optimization algorithm allows you to increase productivity.
Animation	Visual state editor (State machines), which can be linked to game objects and use to create and improve animation; integrated animation editor; create scripts using c#, JavaScript, or Boo; native integration with Visual Studio; realistic animation; one-click placement; optimized graphics.

Here are the advantages and disadvantages of Unity:

-
- advantages:
 - ease of use and performance;
 - a huge number of supported platforms: Windows, iOS, Android;
 - ability to run the project in the browser as an HTML5 application;
 - good performance both in small games on weak mobile platforms, and in difficult big projects on high-end consoles;
 - support for both 2D and 3D modes without much effort;
 - powerful built-in animation system Mechanim;

- C# or JavaScript programming language;
- large community, where you can get support and answers to questions of interest to Unity;
- built-in visual editor, greatly simplifies and speeds up the process of creating a program;
- assets store, a store for developers that opens access to a huge number of models, textures, scripts, and additions for Unity;
- the ability to use a completely free development environment MonoDevelop comes complete with Unity, which is an external IDE (for example, Microsoft Visual Studio or IntelliJ IDEA);
- disadvantages:
 - Unity source code is closed and available only if you purchase an Enterprise license;
 - problems will have to wait for updates and fixes, which sometimes takes quite a long time;
 - lack of such a familiar concept as "game loop" or game cycle - there is no single point of entry, as in other engines, each game object can have a script or several scripts, its own set of events, and its game cycle;
 - unusual and sometimes difficult to master visual editor, which can be a problem for novice developers.

2.2. Capabilities of available SDKs for developing augmented reality applications

SDK (Software development kit) – a set of development tools that allows software professionals to create applications for a specific software package, software basic development tools, hardware platform, computer system, game consoles, operating systems, and other platforms. The SDK takes advantage of each platform and reduces integration time [20].

All SDKs can be divided into two major groups [21]:

1. Created by developers for those who want to make an independent program or game. An example of such an SDK is DirectX, which is installed on almost any computer.
2. Self-sufficient tools. These include the Torque Game Engine SDK from Garage Games – a full-fledged gaming engine that supports the most advanced technologies. Unlike DirectX, with Torque you can create professional games without a deep knowledge of 3D programming technologies. Torque uses a C-shaped scripting programming language.

Let's make a comparative analysis of available SDKs (see table 2 and 3).

To determine the most optimal environment for the development of a mobile application, the method of expert evaluation was used [23].

To this end, the manifestation of each of the defined criteria for each of these development environments was checked, for which the experts were offered a corresponding questionnaire. A total of 20 respondents were involved (experts, deans of faculties, heads, and lecturers of departments of higher education institutions related to the IT field, as well as IT specialists).

Table 2
Overview of augmented reality SDK for iOS and Android [20]

SDK	Description	Supported platforms	Software features	Cost
Wikitude (see figure 1)	A paid platform for working with augmented reality.	Android, iOS, smart glasses.	Three-dimensional tracking technology based on SLAM, GEO Data; image recognition and tracking; cloud recognition.	Free trial. Full functionality starts from € 1990.
Vuforia (see figure 2)	One of the world's most popular platforms to help develop augmented reality.	Android, iOS, UWP and Unity.	Recognition of different types of visual objects (cube, cylinder, plane); text and environment recognition, VuMark (a combination of image and QR code); using Vuforia Object Scanner, you can scan and create object labels, Unity plugin is very powerful and easy to integrate.	Free. But there are also paid plug-ins that cost \$ 99 a month.
Kudan	Vuforia's main competitor greatly simplifies augmented reality development.	Android, iOS.	Recognition of simple images and 3D objects provides easy database generation in the Unity editor.	The free version is for application testing only. The cost of a paid license is \$ 1230.

To determine the degree of manifestation of each criterion, respondents were asked to evaluate its performance on a 4-point scale (from 0 to 3) [23]. The indicator was considered positive if the value of the arithmetic mean of its parameters was not less than 1.5 [23]. The degree of manifestation of the criterion was determined as follows: insufficiently manifested 0–50% of the indicators are positive; critical – 50–55%; sufficient 56–75%; high 76–100% [23].

Analysis of the available environments for the development of AR mobile application allowed to identify the following criteria and relevant indicators for their selection:

1. The *design criterion* characterizes the convenience, accessibility in use, and administration of the environment for the development of AR mobile applications:
 - 1.1. “accessibility” indicator means that the environment for the development of AR mobile applications in the presence of the Internet should be accessible to anyone, as well as anytime and anywhere,
 - 2.2. “multilingualism” indicator implies the presence in the environment for the development of AR mobile application support for different languages.
 - 3.3. “ease of use and administration” indicator implies that the environment for the development of AR mobile application should be easy to use, also provides convenience and clarity in use, organization of access, and more,
 - 4.4. “free of charge” indicator assumes the availability of a free tariff plan, which may not be fully functional,



Figure 1: Wikitude.



Figure 2: Vuforia.

- 5.5. “multiplatform” indicator characterizes the environment for the development of AR mobile applications in terms of adaptation to use in different operating systems (Windows, Android, iOS, etc.).
2. The *functional criterion* characterizes the environment for the development of AR mobile application from a technical point of view, and provides for the presence of the following indicators:
 - 2.1. “recognition of different types of visual objects” indicator involves the recognition of different types of visual objects such as cube, cylinder, plane,

Table 3
Overview of augmented reality SDK for iOS and Android [20]

SDK	Description	Supported platforms	Software features	Cost
Maxst (see figure 3)	See [22].	Android, iOS, Windows, macOS.	Offers two different tools for pattern and environment recognition, database creation online through Tracking Manager.	The free version differs from the paid one only by a watermark. The PRO version costs \$ 999.
Xzimg (see figure 4)	Represents three products for working with applications based on augmented reality: Augmented Face, Augmented Vision and Magic Face.	Android, iOS, Windows, WebGL.	Xzimg Augmented Face recognizes and tracks faces with Unity; Xzimg Augmented Vision recognizes and tracks flat images from Unity; Xzimg Magic Face is designed to replace facial features and apply makeup.	A free trial is only available for demonstration (inverts color and changes images). The paid version costs € 1600.
NyARToolkit (see figure 5)	Japanese augmented reality library based on ARToolkit.	Android, iOS.	Used only for image identification and tracking, easily integrated, but English version not available.	Free.
Metaio SDK	Library for creating augmented reality mobile applications.	Windows, macOS, iOS and Android	Uses OpenGL, SLAM methods for more accurate operation. Allows developers to use content without prior encryption to implement augmented reality in any application, offering modules for tracking three-dimensional objects, face recognition and tracking, infrared and laser tracking, advanced camera calibration, and transparent optics. No offline tools or server encryption are required to deploy 3D models and track data.	Free

- 2.2. “text and environment recognition” indicator characterizes whether the text and, accordingly, the environment will be recognized,
- 2.3. “combination of image and QR code” indicator involves the integration of the QR-code with the image,
- 2.4. “database creation” indicator characterizes whether it is possible to create databases

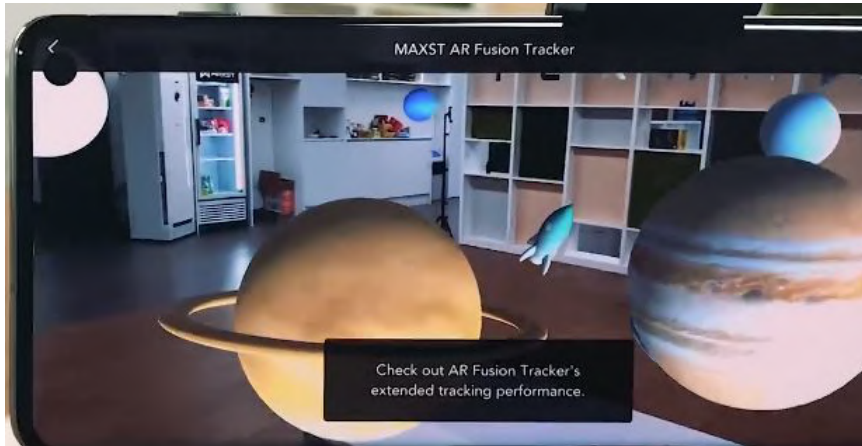

Figure 3: Maxst.



Figure 4: Xzing.

in different ways.

Basic data on the indicators of the design criterion for each of the selected environments for the development of AR mobile application contains a table 4.

Basic data on the indicators of the functional criterion for each of the selected environments for the development of AR mobile application contains a table 5.

The generalized results are presented in table 6.

A review of alternatives based on the most important criteria showed that the most optimal

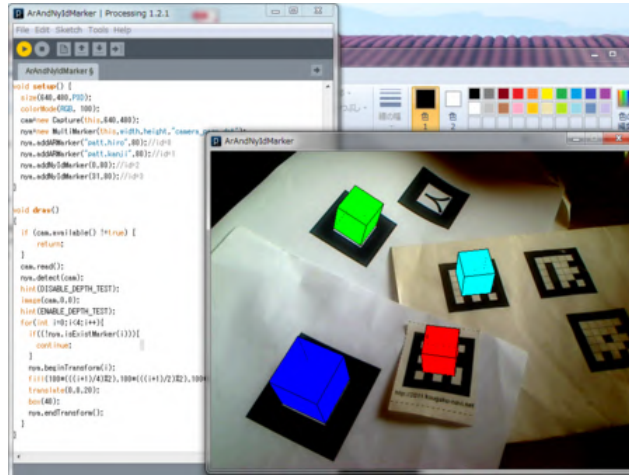

Figure 5: NyARToolkit.

Table 4

Design criterion of environments for AR application development and its indicators

Service	Indicators					Manifestation of the criterion
	1.1	1.2	1.3	1.4	1.5	
wikitude	0.7	1.45	1.7	0.3	1.5	40%
Vuforia	2.5	2.25	2.45	2.15	2.8	100%
Kudan	1.45	1.85	2.7	0.25	1.45	40%
Maxst	2.1	1.45	2.25	1.45	2.2	60%
Xzing	0.3	1.3	2.5	0.15	2.45	40%
NyARToolkit	2.3	0.2	2.4	2.6	1.4	60%
Metaio SDK	2.3	1.55	2.4	2.6	2.1	100%

environment for developing a mobile application is Vuforia [24]. Vuforia SDK is a mobile software that allows you to create augmented reality applications. It uses computer vision technology to recognize and track flat images and simple 3D objects in real-time.

The ability to register images allows developers to locate and orient virtual objects, such as 3D models and media content, in conjunction with real images when viewed through the cameras of mobile devices. The virtual object is oriented on the real image so that the observer's point of view on the object is correlated with their point of view on the image to achieve the main effect – the feeling that the virtual object is part of the real world. The developed augmented reality application allows virtual 3D objects to be superimposed on the video stream in real-time.

The application starts by initializing the camera, requesting a video stream, and selecting a frame from the stream. Next, you need to find the desired image on the selected frame, namely the marker. If a marker is found, the software uses a mathematical apparatus to calculate the camera's position relative to that marker. When the camera position is determined, the graphic model is displayed directly in that position. The graphic model is displayed on top of the video and is attached to the marker. As a result, the information is superimposed on top of the frame.

Table 5

Functional criterion of environments for AR application development and its indicators

Service	Indicators				Manifestation of the criterion
	2.1	2.2	2.3	2.4	
wikitude	1.85	1	0	0.2	25%
Vuforia	2.85	2.7	2.7	2.8	100%
Kudan	2.5	0.4	0.6	2.35	50%
Maxst	1.95	1.45	1.1	2.1	50%
Xzimg	2.55	1.6	0.4	0.8	50%
NyARToolkit	1.8	0.55	0.45	0.3	25%
Metaio SDK	2.65	2.7	0.9	0.9	50%

Table 6

The results of selection of the environment for development of AR of the mobile application on manifestation of all criteria are generalized

Service	Criterion	
	Design	Functional
wikitude	40%	25%
Vuforia	100%	100%
Kudan	40%	50%
Maxst	60%	50%
Xzimg	40%	50%
NyARToolkit	60%	25%
Metaio SDK	100%	50%

If the marker is not detected, the frame is re-selected from the video stream.

3. Conclusions

There is no single approach to the choice of a tool for the development of augmented reality technologies, different authors characterize their choice based on the number of supported platforms, ease of transferring code to different platforms, performance, and more.

Depending on the purpose of the application, you can use not only cross-platform engines but also sets of development tools. Such kits allow you to speed up and simplify the process of developing any program with elements of augmented reality. These advantages and disadvantages will help beginners to choose the most convenient tool for developing augmented reality technologies.

References

- [1] T. Kramarenko, O. Pylypenko, V. Zaselskiy, Prospects of using the augmented reality application in STEM-based Mathematics teaching, CEUR Workshop Proceedings 2547

- (2020) 130–144.
- [2] L. Y. Midak, I. V. Kravets, O. V. Kuzyshyn, L. V. Baziuk, K. V. Buzhdyhan, J. D. Pahomov, Augmented reality as a part of STEM lessons, *Journal of Physics: Conference Series* 1946 (2021) 012009. doi:10.1088/1742-6596/1946/1/012009.
 - [3] A. Striuk, M. Rassovytska, S. Shokaliuk, Using Blippar augmented reality browser in the practical training of mechanical engineers, *CEUR Workshop Proceedings* 2104 (2018) 412–419.
 - [4] O. Lavrentieva, I. Arkhypov, O. Kuchma, A. Uchitel, Use of simulators together with virtual and augmented reality in the system of welders' vocational training: Past, present, and future, *CEUR Workshop Proceedings* 2547 (2020) 201–216.
 - [5] A. Kiv, M. Shyshkina, S. Semerikov, A. Striuk, Y. Yechkalo, AREdu 2019 – How augmented reality transforms to augmented learning, *CEUR Workshop Proceedings* 2547 (2020) 1–12. URL: <http://ceur-ws.org/Vol-2547/paper00.pdf>.
 - [6] V. Morkun, N. Morkun, A. Pikilnyak, Augmented reality as a tool for visualization of ultrasound propagation in heterogeneous media based on the k-space method, *CEUR Workshop Proceedings* 2547 (2020) 81–91. URL: <http://ceur-ws.org/Vol-2547/paper06.pdf>.
 - [7] Y. Chen, Q. Wang, H. Chen, X. Song, H. Tang, M. Tian, An overview of augmented reality technology, *Journal of Physics: Conference Series* 1237 (2019) 022082. doi:10.1088/1742-6596/1237/2/022082.
 - [8] O. Kanivets, I. Kanivets, N. Kononets, T. Gorda, E. Shmeltser, Development of mobile applications of augmented reality for projects with projection drawings, *CEUR Workshop Proceedings* 2547 (2020) 262–273. URL: <http://ceur-ws.org/Vol-2547/paper19.pdf>.
 - [9] V. Bilous, V. Proshkin, O. Lytvyn, Development of ar-applications as a promising area of research for students, *CEUR Workshop Proceedings* 2731 (2020) 205–216. URL: <http://ceur-ws.org/Vol-2731/paper11.pdf>.
 - [10] V. Hordiienko, G. Marchuk, T. Vakaliuk, A. Pikilnyak, Development of a model of the solar system in AR and 3D, *CEUR Workshop Proceedings* 2731 (2020) 217–238. URL: <http://ceur-ws.org/Vol-2731/paper12.pdf>.
 - [11] M. Shyshkina, M. Marienko, Augmented reality as a tool for open science platform by research collaboration in virtual teams, *CEUR Workshop Proceedings* 2547 (2020) 107–116. URL: <http://ceur-ws.org/Vol-2547/paper08.pdf>.
 - [12] A. Iatsyshyn, V. Kovach, Y. Romanenko, I. Deinega, A. Iatsyshyn, O. Popov, Y. Kutsan, V. Artemchuk, O. Burov, S. Lytvynova, Application of augmented reality technologies for preparation of specialists of new technological era, *CEUR Workshop Proceedings* 2547 (2020) 181–200. URL: <http://ceur-ws.org/Vol-2547/paper14.pdf>.
 - [13] L. Midak, I. Kravets, O. Kuzyshyn, J. Pahomov, V. Lutsyshyn, A. Uchitel, Augmented reality technology within studying natural subjects in primary school, *CEUR Workshop Proceedings* 2547 (2020) 251–261. URL: <http://ceur-ws.org/Vol-2547/paper18.pdf>.
 - [14] N. Rashevskaya, S. Semerikov, N. Zinonos, V. Tkachuk, M. Shyshkina, Using augmented reality tools in the teaching of two-dimensional plane geometry, *CEUR Workshop Proceedings* 2731 (2020) 79–90. URL: <http://ceur-ws.org/Vol-2731/paper03.pdf>.
 - [15] V. Oleksiuk, O. Oleksiuk, Exploring the potential of augmented reality for teaching school computer science, *CEUR Workshop Proceedings* 2731 (2020) 91–107. URL: <http://ceur-ws.org/Vol-2731/paper04.pdf>, 3rd International Workshop on Augmented Reality

- in Education, AREdu 2020 ; Conference Date: 13 May 2020.
- [16] O. Haranin, N. Moiseienko, Adaptive artificial intelligence in RPG-game on the Unity game engine, CEUR Workshop Proceedings 2292 (2018) 143–150.
 - [17] O. Katsko, N. Moiseienko, Development computer games on the Unity game engine for research of elements of the cognitive thinking in the playing process, CEUR Workshop Proceedings 2292 (2018) 151–155.
 - [18] O. Prokhorov, V. Lisovichenko, M. Mazorchuk, O. Kuzminska, Developing a 3D quest game for career guidance to estimate students' digital competences, CEUR Workshop Proceedings 2731 (2020) 312–327.
 - [19] Unity guide, 2010. URL: <https://docs.unity3d.com/Manual/index.html>.
 - [20] A. Lisovitckii, 8 best-augmented reality SDKs for iOS and Android in 2017, 2017. URL: <https://holographica.space/articles/8-best-ar-sdk-2017-9287>.
 - [21] A. Averkina, O. Lazareva, Augmented reality systems for mobile platforms, Bulletin of the Moscow State University of Printing 1 (2015).
 - [22] O. Syrovatskyi, S. Semerikov, Y. Modlo, Y. Yechkalo, S. Zelinska, Augmented reality software design for educational purposes, CEUR Workshop Proceedings 2292 (2018) 193–225. URL: <http://ceur-ws.org/Vol-2292/paper20.pdf>.
 - [23] O. Gavryliuk, T. Vakaliuk, V. Kontsedailo, Selection criteria for cloud-oriented learning technologies for the formation of professional competencies of bachelors majoring in statistics, SHS Web of Conferences 75 (2020) 04012. doi:10.1051/shsconf/20207504012.
 - [24] S. Zelinska, A. Azaryan, V. Azaryan, Investigation of opportunities of the practical application of the augmented reality technologies in the information and educative environment for mining engineers training in the higher education establishment, CEUR Workshop Proceedings 2257 (2018) 204–214.

Using augmented reality for architecture artifacts visualizations

Zarema S. Seidametova¹, Zinnur S. Abduramanov¹ and Girey S. Seydametov¹

¹Crimean Engineering and Pedagogical University, 8 Uchebnyi per., Simferopol, 95015, Crimea

Abstract

Nowadays one of the most popular trends in software development is Augmented Reality (AR). AR applications offer an interactive user experience and engagement through a real-world environment. AR application areas include archaeology, architecture, business, entertainment, medicine, education and etc. In the paper we compared the main SDKs for the development of a marker-based AR apps and 3D modeling freeware computer programs used for developing 3D-objects. We presented a concept, design and development of AR application “Art-Heritage” with historical monuments and buildings of Crimean Tatars architecture (XIII-XX centuries). It uses a smartphone or tablet to alter the existing picture, via an app. Using “Art-Heritage” users stand in front of an area where the monuments used to be and hold up mobile device in order to see an altered version of reality.

Keywords

Augmented Reality, smartphones, mobile-AR, architecture artifact, ARToolkit, Vuforia

1. Introduction

In recent years, Augmented Reality (AR) has been named as one of the top 10 new technology trends. AR technology has primarily been used for gaming but nowadays it has also found widespread use in education, training, medicine, architecture, archeology, entertainment, marketing and etc. According to the International Data Corporation (IDC) [1] worldwide spending on AR and virtual reality (VR) is growing from just over \$12.0 billion this year to \$72.8 billion in 2024.

AR as technology allows researchers, educators and visual artists to investigate a variety of AR apps possibilities using mobile AR in many areas – from education [2, 3, 4, 5, 6] to cultural heritage [7, 8, 9, 10, 11].

In the paper [12] authors provided an overview of Augmented Paper Systems use in education. Studies related to the effect of augmented reality on learning efficiency presented in papers [13, 14], in which also discussed questions on how to combine the capabilities of augmented

AREdu 2021: 4th International Workshop on Augmented Reality in Education, May 11, 2021, Kryvyi Rih, Ukraine

✉ z.seydametova@gmail.com (Z. S. Seidametova); abduramanov.z.s@gmail.com (Z. S. Abduramanov); s.girey.s@gmail.com (G. S. Seydametov)

🌐 <http://cepulib.ru/index.php/ru/resursy/personalii/47-s-personalii/169-sejdametova-zarema-sejdalievna> (Z. S. Seidametova); <https://kipu-rc.ru/sotrudniki/103-abduramanov-zinnur-shevketovich.html> (Z. S. Abduramanov); <https://kipu-rc.ru/fakultet-ekonomiki/kafedra-prikladnoj-informatiki.html?id=107> (G. S. Seydametov)

🆔 0000-0001-7643-6386 (Z. S. Seidametova); 0000-0002-2818-4759 (Z. S. Abduramanov); 0000-0002-1004-4141 (G. S. Seydametov)



© 2021 Copyright for this paper by its authors.
Use permitted under Creative Commons License Attribution 4.0 International (CC BY 4.0).

CEUR Workshop Proceedings (CEUR-WS.org)

reality and learning activities. The educational potential of augmented reality technology and benefits which AR can bring to teaching and learning discussed in the papers [15, 16, 17, 18, 19].

An experience of the successful use of AR mobile applications in learning and teaching process described in [20, 21]. There is large number of studies, which identified the future trends, affordances and challenges of AR systems in education. The papers [22, 23, 24, 25, 26] provided research on the problems that can help to improve the experience of using AR systems in education and authors of papers suggested the new AR educational tools [27, 28, 29].

Garzón et al. [30] highlighted five directions for future research: (1) design of AR systems that consider special needs of particular users; (2) integration of AR systems into unexplored fields of education; (3) inclusion of AR systems into learning processes of unexplored target groups; (4) integration of AR systems into business and industry; (5) design of pedagogically efficient AR systems.

Radu [31] provided a comprehensive understanding of how the medium of augmented reality differs from other educational mediums. Research of Garzón et al. [32] identifies positive and negative effects that AR experiences can bring to learners.

The authors of the papers [33, 34, 35, 36, 37, 38] proposed functional mobile augmented reality applications for different domains not only for education. In papers [39, 40] researchers discussed the effects of marketing, usability, design on augmented reality technologies and ways of the development of AR apps. Comparative analysis of augmented reality frameworks that are used to develop educational and industrial applications presented in [41, 42, 43, 44].

Mekni and Lemieux [45] introduced in the technologies that enable an augmented reality experience, clarifies the boundaries that exist between AR and Virtual Reality (VR); classified the AR-applications into distinct categories: medical, military, manufacturing, entertainment, visualization, robotics, education, marketing, geospatial, navigation and path planning, tourism, urban planning and civil engineering.

The paper [46] provided an overview of 3D interaction techniques in mobile AR, authors described three main interaction technique categories that applicable in mobile AR: touch-based interaction, mid-air gestures-based interaction, and device-based interaction techniques.

The paper [47] investigated the AR technology with a approach based on patent research. Authors searched the United States Patent and Trademark Office (USPTO) for AR-related granted patents in the period 1993–2018. The study found that AR technological development has especially increased in the last decade.

The rest of the paper is organized and structured as follows. Section two, presents an explanation of concepts and technologies of the different new trends such as Virtual, Augmented Reality and Mixed Reality. Section three, explores 3D modeling of the “Art-Heritage” application objects. Section four, presents the “Art-Heritage” application server configuration. Conclusion and future work is presented in section five.

2. Concepts and technologies of the Extended Reality

Virtual Reality (VR), Augmented Reality (AR) and Mixed Reality (MR) technologies can be described with an umbrella term Extended Reality (XR). XR covers all of the various technologies that giving additional information about the real world or creating virtual worlds:

- AR adds digital objects to a live view by using the camera on a smartphone (for example, Snapchat lenses, Google’s “Just a line”, Pokemon Go, etc.). AR contains following basic features: a combination of real and virtual worlds, real-time interaction, and accurate 3D registration of virtual and real objects.
- VR devices such as HTC Vive Headset, Oculus Rift, Oculus Quest 2, Sony PlayStation VR, HP Reverb G2 or Google Cardboard move users into a number of real-world and imagined environments. VR is digital, computer-generated and 3D environment that allows the user to step inside the virtual world. There are main types of VR simulations used today: non-immersive, semi-immersive, and fully-immersive simulations.
- MR combines elements of both AR and VR, real-world and digital objects interact. MR-technology is starting to take off with Microsoft’s HoloLens. Physical and digital elements exist and interact in real time in mixed reality (MR) applications. MR merges real and virtual worlds, and allow to produce new environments. There are a lot of MR-applications for design, entertainment, training, learning, architecture, healthcare and etc. MR is the area between the real and the virtual worlds and can be represent as augmented reality (the virtual augments the real) and as augmented virtuality (the real augments the virtual).

AR software development kit (SDK) allows developers to build objects that appear to blend into the real world. The AR SDKs offer functions such as 3D object tracking, image recognition, visual search, multi-tracking, and more, which allow developers to produce digital images. There many different SDKs for creating custom AR experiences. The comparison of the most popular AR SDKs based on license type, marker, 3D object tracking, visual search and content API is presented in the table 1.

For development of the “Art-Heritage” application we chose the Unity platform and Vuforia SDK because of the accessibility, availability of the necessary functionality, the possibility of connecting additional sets of development tools and the availability of peripheral (additional) services. The main benefits are that Vuforia enables to maintain tracking even when the target is out of view and Vuforia has cloud database for storing image targets.

The “Art-Heritage” application research objective created in order to promote Crimean tatars historical monuments in the Crimea [48, 49] that are currently destroyed. The “Art-Heritage” is AR application. We recreated four models: Khan Baths (Hammam), Devlet Palace (Sarai), Mengli Geray Mosque, Yesil-Jami Mosque in the “Art-Heritage” app. The interface of the “Art-Heritage” application is presented in the figure 1.

3. 3D modeling of the “Art-Heritage” application objects

3D modeling is used in various industries like movie, animation and gaming, interior design and architecture. They are also used in the medical industry to create interactive representations of anatomy objects or in military training to decorate the environment of the 3D immersive worlds. A wide range of the 3D applications are also used in constructing digital representation of models, assembling elements and observing their functionality.

The list of some 3D modeling freeware computer programs used for developing a mathematical representation of 3D-objects and supported 3D rendering is following:

Table 1

Comparison of the most popular Augmented Reality SDK (based on [41])

AR SDK	Type	Marker	3D object tracking	Visual Search	Content API
EasyAR	Free + Commercial SDK	+	+		
HERE Mobile SDK	Free + Commercial SDK	+			HERE Maps, LiveSight API
Kudan AR Engine	Free + Commercial SDK	+	+	unlimited local visual search (no network connection required)	
Wikitude	Free + Commercial SDK	advanced	+	Cloud Recognition and Offline (on device)	with Wikitude Studio and Cloud Recognition
Vuforia	Free + Commercial SDK	Advanced, VUmark	Only on box and cylinder and small size 3D objects	+	With Vuforia Cloud
DroidAR	Free	+	+	can be added via openCV	OpenGL, jMonkey engine
Xludia	Commercial SDK only	Markerless	+	+	REST
Catchoom	Free + Commercial SDK	Markerless		Supports both cloud for very large collections and on-device search of hundreds of images	
ARLab	Free + Commercial SDK	QR codes		Support for thousands of images in pools of 50-60 images	

- **3D Slash** (<https://3dslash.net>) offers complex geometrical shapes to handle (cylinder, sphere or cone), the bucket (to fill in with cuboid an identified volume). 3D Slash app is available for Windows, MacOS and Linux. A special version is also available for Raspberry Pi.
- **Anim8or** (<https://anim8or.com/>) is an OpenGL-based 3D modeling and animation program. The interface is separated into four sections (with its own tools): object editor, figure editor, sequence editor, scene editor.
- **Art of Illusion** (<http://artofillusion.org/>) provides tools for 3D modeling, texture mapping, and 3D rendering images and animations. It can also export models for 3D printing in the STL file format.
- **AutoQ3D Community** (<https://www.autoq3d.com/>) is a cross-platform CAD software, suited for beginners who want to make rapid 3D modeling, texturing, sketching and drawing in 3D.



Figure 1: The interface of the “Art-Heritage” application.

- **Blender** (<https://www.blender.org/>) is an open-source 3D graphics software toolset used for creating animations, visual effects, paintings, 3D printed models, interactive 3D applications, virtual reality, and computer games.
- **BRL-CAD** (<https://brlcad.org/>) is a modeling computer-aided design system and includes an interactive geometry editor. It can be used for a variety of engineering and graphics applications.
- **Clara.io** (<https://clara.io/>) is a full-featured cloud-based 3D modeling, animation and rendering software tool that runs in browser.
- **Daz Studio** (https://www.daz3d.com/daz_studio/) is a 3D scene creation and rendering application used to produce images, animations.
- **DesignSpark Mechanical** (<https://www.rs-online.com/designspark/mechanical-software>) is 3D computer-aided design modeling software for modeling in a 3D environment and creating files for use with 3D printers.
- **FreeCAD** (<https://www.freecadweb.org/>) is an open-source general-purpose parametric 3D computer-aided design modeler and a building information modeling software.
- **Makers Empire 3D** (<https://www.makersempire.com/>) is designed to introduce 4-13 year old students to “design thinking” and engage them in authentic, real-world problem solving via 3D design and 3D printing.
- **Open CASCADE** (<https://www.opencascade.com/open-cascade-technology/>) is an open-source software development platform for 3D CAD, CAM, CAE. It is a software devel-

opment kit (SDK) intended for the development of applications dealing with 3D CAD data.

- **OpenSCAD** (<http://www.openscad.org/>) is an application for creating solid 3D CAD objects. An OpenSCAD script specifies geometric primitives (such as spheres, boxes, cylinders, etc.) and defines how they are modified and combined to render a 3D model.
- **Sculptris** (<https://zbrushcore.com/mini/>) is a virtual sculpting software program with a primary focus on the concept of modeling clay. 3D meshes (.obj) can be imported into the program for further detailing, generating normal and displacement maps. Application functions are sculpting, dynamic tessellation, UV texture painting, cavity painting.
- **Seamless3d** (<http://www.seamless3d.com/>) is an open-source free 3D modeling software and available under the MIT license.
- **SelfCAD** (<http://selfcad.com/>) is an online computer-aided design browser-based and cloud-based software for 3D modeling and 3D printing. It is an online software as a Service and allows users to model, sculpt and slice for 3D design and 3D printing.
- **SketchUp** (<https://www.sketchup.com/>) is a 3D modeling software for applications such as architectural, interior design, landscape architecture, civil and mechanical engineering, film and video game design. It is available as a web-based application. It has an open library 3D Warehouse in which users may upload and download 3D models to share.
- **Sweet Home 3D** (<http://www.sweethome3d.com/>) is an architectural design software application for creating a 2D plan of a house, with a 3D preview, and decorating exterior and interior view including ability to place furniture and home appliance. In Sweet Home 3D, furniture can be imported and arranged to create a virtual environment.

All 3D models of the “Art-Heritage” app were created using SketchUp. The main advantage of SketchUp is the ability of the program to suggest the most convenient next step and method of action. In SketchUp there are many useful tools like geometric modeling and drawing, which includes many functions, construction, also represented by various possibilities. Figure 2 presents the 3D model of the Khan Baths (Hammam) of the 15th century that used to be located in the neighborhood of Zincirli Madrasa (Bakhchysarai, Crimea).

Convention of the objects modeling for the “Art-Heritage” Platform:

(strict adherence to all clauses of the convention is assumed)

1. 3D modeling software: preferably **SketchUp**, other options can be discussed.
2. Texture resolution: **512×512 px**.
3. Number of polygons: up to about **50,000**.
4. Do not allow unnecessary meshes in the model. **Only the exterior view of the object** is required.
5. **If the object exceeds the permissible norm**, then it is required to reduce the detail of ornaments and other small elements:
 - if the ornament is on a plane and it is possible to replace a complex three-dimensional pattern with a texture, then it is recommended to replace it with a more geometrically simple element (cone, spheres, boxes, cylinders, etc.) with further texture overlay on this object,

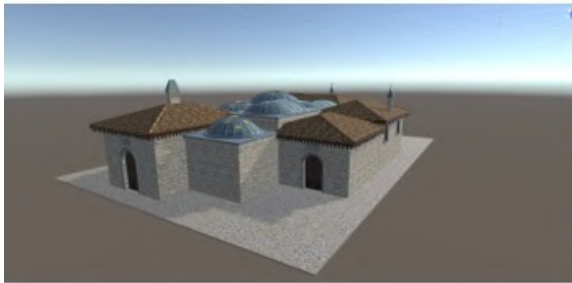

Figure 2: “Art-Heritage” 3D model of the Khan Baths (Hamam) of the 15th century that used to be located in the neighborhood of Zincirli Madrasa (Bakhchysarai, Crimea).

- if possible, you can resort to reducing the polygonality of some decorative elements, but so that the appearance does not suffer (as much as possible).

(important notice: *to optimize from less significant details to more significant ones* - i.e. it is better to neglect the quality of some insignificant, inconspicuous element than the one that first catches the user’s eye).

For visualization of 3d models in the “Art-Heritage” app we use QR-codes. Figure 3 presents the stand with QR-codes, the Khan Baths (Hamam) 3D model’s QR-code and the image of the Mengli-Geray Mosque

4. The “Art-Heritage” application server

Server part of the “Art-Heritage” application.

It is used Virtual Dedicated Server (VDS) for working with the database storing 3D models data. To provide access to 3D models data through the API we use a RESTful web service that is well suited for creating API for client spread out across the Internet. Client and server exchange



Figure 3: The Stand with QR-codes for “Art-Heritage” 3D models. The Khan Baths (Hamam)3D model’s QR-code; the image of the Mengli-Geray Mosque.

representations of resources by using a standardized interface and protocol. The access to calling API methods have only those routers whose data are stored on the server in the database and located in the same Virtual Local Area Network (VLAN). VLAN is a function in routers and switches that allows to create multiple VLANs on one physical network interface (Ethernet, Wi-Fi interfaces). VLANs are used to create a logical network topology that is independent of the physical topology.

A Virtual Private Network (VPN) tunnel with a pool of addresses is configured on the VDS server. VPN is a secure, encrypted connection between two networks or between a user and a network. When registering a new museum or adding an additional access point to the museum, the router (which is located in the museum) receives its IP address in the pool and binds to the MAC address.

Client part of the “Art-Heritage” application.

The client is provided with a router based on “routerboard”. When registering an access point, the museum receives a login and password for the CRM control panel, from where it can control the activity of the access point.

The client downloads the firmware (which is assigned to one router) and automatically flashes the router (manual configuration is also possible). Important note: the client's router must have a USB connector that can work with external drives that could store 3D models.

After the tunnel is built on both sides, the server checks for the presence of 3D models that are assigned to a specific router on its drive and performs synchronization (if it is necessary, the models are downloaded from the server to the server's local storage).

When flashing a router, hotspot has a strictly fixed pool of addresses, in particular the IP of the gateway, since the URLs in the application are hardcoded to work with models from the museum's local storage. Sharing a local drive that is connected to the router is implemented using FTP server on the local router.

Figure 4 shows a fragment of the listing of the router_config.rsc file for configuring the hotspot and routing.

```
#-----  
# Hotspot Setup  
#-----  
  
/ip hotspot profile  
add hotspot-address=xxx.xxx.xxx.xxx html-directory="/disk1/hotspot" login-by=http-pap name=arhsprof  
/ip hotspot user profile  
set [ find default=yes ] idle-timeout=1d keepalive-timeout=1d on-login="/ip firewall address-list add  
list=AUTHORIZED address=\$address timeout=24:00:00" on-logout="/ip firewall address-list remove  
list=AUTHORIZED address=\$address"  
add name=uprof1 shared-users=50  
/ip hotspot user add name="<hotspotUser>" password="<hotspotPassword>" profile=uprof1  
/ip hotspot add address-pool=hs-dhcp addresses-per-mac=200 disabled=yes interface=bridge  
name=ARHotspot profile=arhsprof  
/ip dns set allow-remote-requests=yes cache-size=1048KiB max-udp-packet-size=512  
servers=8.8.8.8,8.8.4.4  
/ip firewall nat add action=masquerade chain=srcnat comment="masquerade hotspot network" src-  
address=xxx.xxx.xxx.xxx/xx  
  
# Routing  
/interface pptp-client add name=arch connect-to="<host>" user="<Username>"  
password="<Password>" disabled=no  
/ip firewall nat add chain=srcnat out-interface=arch action=masquerade  
/ip firewall mangle add chain=prerouting src-address=xxx.xxx.xxx.xxx-xxx.xxx.xxx.xxx action=mark-  
routing new-routing-mark=PPTP  
/ip hotspot walled-garden ip add action=accept disabled=no dst-host="crm.****.com"  
/ip hotspot walled-garden ip add action=accept disabled=no dst-host="www.****.com"  
/ip route add dst-address=0.0.0.0/0 gateway=arch routing-mark=PPTP  
/ip dns static add name=archdns address="<Gateway>"
```

Figure 4: A fragment of the listing of the router_config.rsc file for configuring the hotspot and routing.

The figure 5 presents the detail how operations are carried out and the interaction between objects in the context of a collaboration.

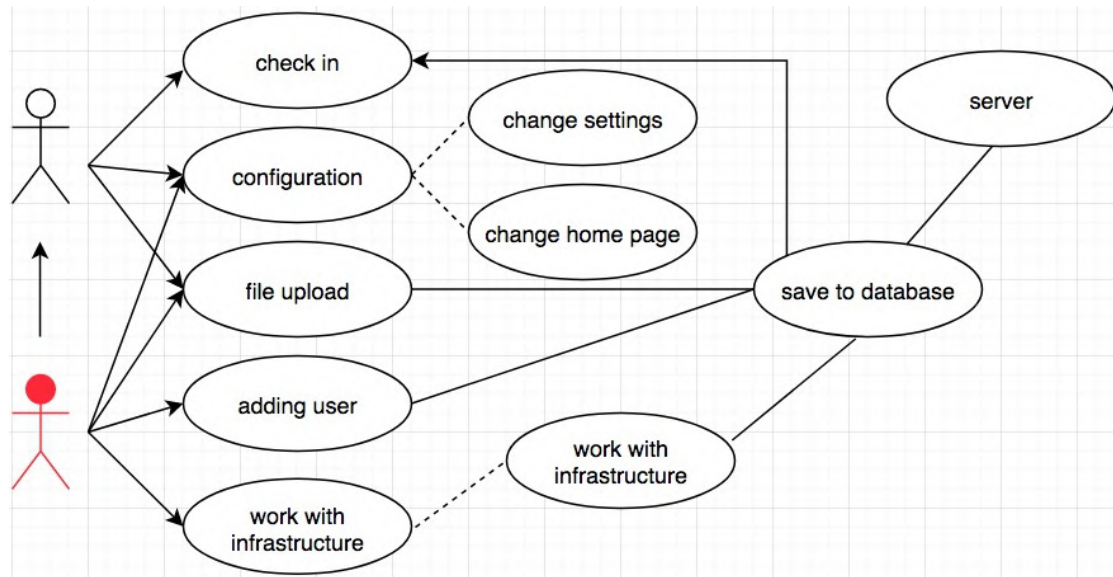

Figure 5: The use case diagram of the “Art-Heritage” application.

The figure 6 presents sequence diagram of the “Art-Heritage” application. The sequence diagram shows objects (user, REST controller, service, data access) interactions arranged in time sequence. The sequence of messages exchanged between the objects needed to carry out the functionality of the of the “Art-Heritage” app scenario. The figure 7 the activity diagram of the “Art-Heritage” application that visually presents a series of actions in a system.

The class diagram of the “Art-Heritage” application is presented in the figure 8.

5. Conclusions

Nowadays the Augmented Reality is one of the most popular trends in software development and one of the most innovative initiatives in education. AR applications offer an interactive user experience and engagement through a real-world environment. The AR technology opens a new horizon for the development of mobile AR applications for archaeology, architecture, business, entertainment, medicine, education. There are a lot of SDKs for the development of a marker-based AR apps that give an opportunity to add a third dimension to displays, bringing objects or scenes to life. There are many computer programs for modeling 3D objects that can be superimposed computer-generated images over real-world views.

The AR application “Art-Heritage” developed by us gives the opportunity to bring the monuments of Crimean Tatars cultural heritage to life and learn their stories. The learning is accompanied by 3D visualization and animation of each monument.

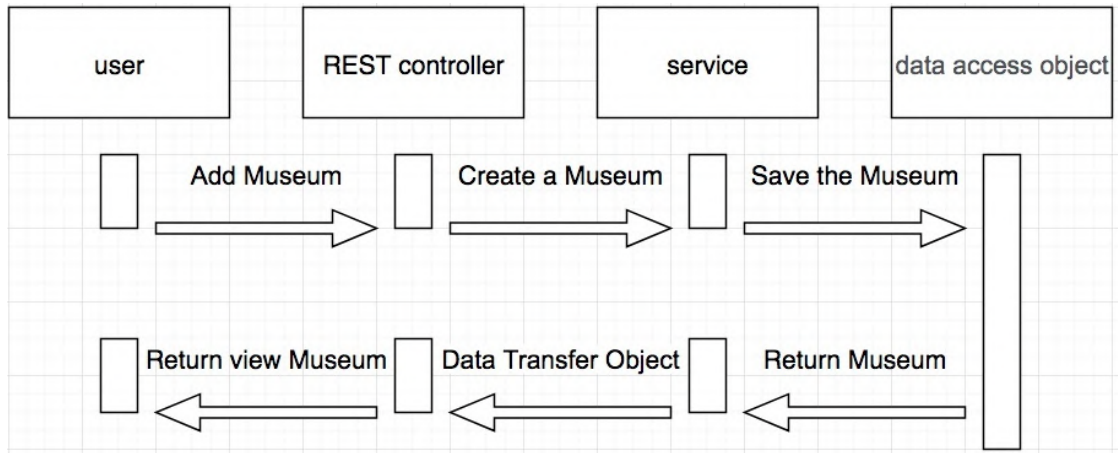

Figure 6: The sequence diagram of the “Art-Heritage” application.

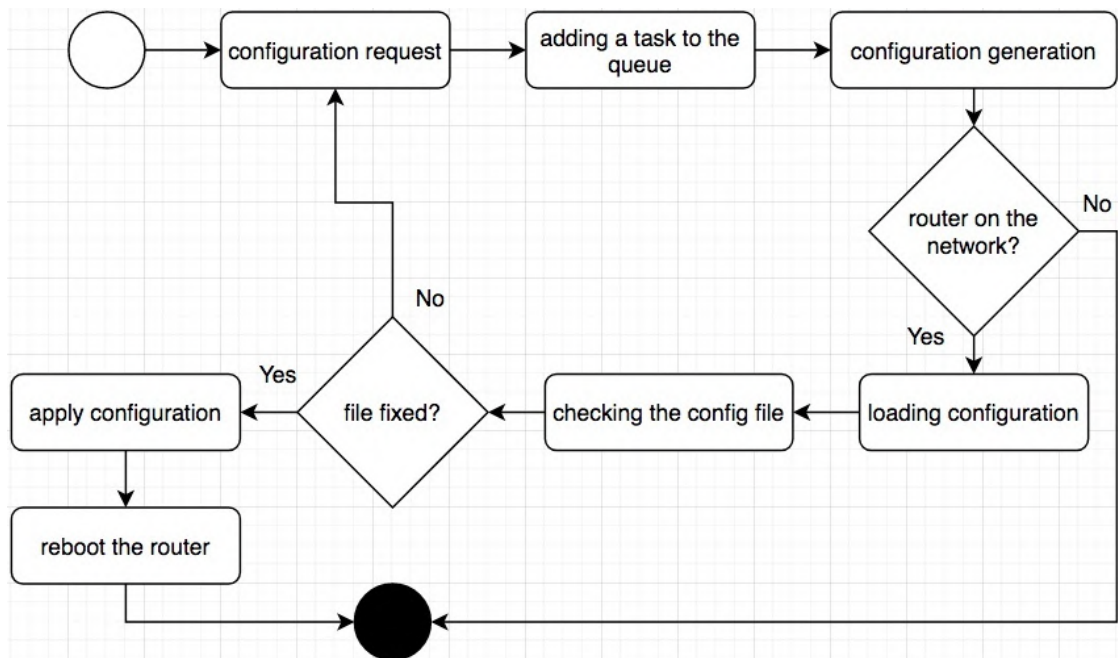

Figure 7: The activity diagram of the “Art-Heritage” application.

In addition, the experience gained from the development of the “Art-Heritage” application opens up a new look at the development of mobile AR applications and at the router configuration. In the future we plan to introduce larger numbers of 3D models for architectural historic artifacts, expand the local database of 3D objects, audio explanations to accompany the story of each model.

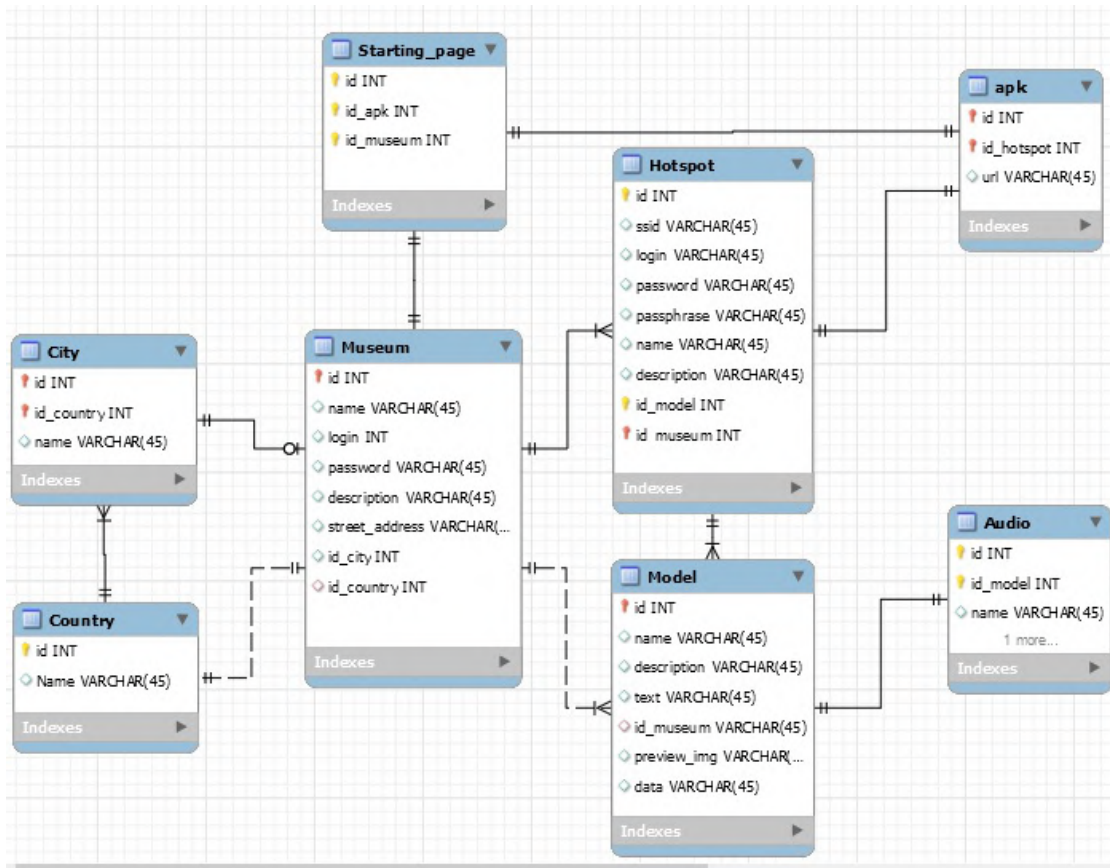

Figure 8: The class diagram of the “Art-Heritage” application.

References

- [1] Worldwide spending on augmented and virtual reality forecast to deliver strong growth through 2024, according to a new idc spending guide, 2020. URL: <https://www.idc.com/getdoc.jsp?containerId=prUS47012020>.
- [2] J. Martín-Gutiérrez, C. E. Mora, B. Añorbe-Díaz, A. González-Marrero, Virtual technologies trends in education, *Eurasia Journal of Mathematics, Science and Technology Education* 13 (2017) 469–486. doi:10.12973/eurasia.2017.00626a.
- [3] J. Bacca, S. Baldiris, R. Fabregat, S. Graf, Kinshuk, Augmented reality trends in education: A systematic review of research and applications, *Journal of Educational Technology & Society* 17 (2014) 133–149. URL: <http://www.jstor.org/stable/jeductechsoci.17.4.133>.
- [4] P. Nechypurenko, T. Starova, T. Selivanova, A. Tomilina, A. Uchitel, Use of augmented reality in chemistry education, *CEUR Workshop Proceedings* 2257 (2018) 15–23.
- [5] S. Zelinska, A. Azaryan, V. Azaryan, Investigation of opportunities of the practical application of the augmented reality technologies in the information and educative environment

- for mining engineers training in the higher education establishment, *CEUR Workshop Proceedings* 2257 (2018) 204–214.
- [6] S. Iwin Thanakumar Joseph, S. B. E. Raj, J. M. Kiyasudeen, Virtual reality – a paradigm shift in education pedagogy, in: *2020 Seventh International Conference on Information Technology Trends (ITT)*, 2020, pp. 72–79. doi:10.1109/ITT51279.2020.9320880.
- [7] A. Angelopoulou, D. Economou, V. Bouki, A. Psarrou, L. Jin, C. Pritchard, F. Kolyda, Mobile augmented reality for cultural heritage, in: N. Venkatasubramanian, V. Getov, S. Steglich (Eds.), *Mobile Wireless Middleware, Operating Systems, and Applications*, Springer Berlin Heidelberg, Berlin, Heidelberg, 2012, pp. 15–22.
- [8] H. Kim, T. Matuszka, J.-I. Kim, J. Kim, W. Woo, Ontology-based mobile augmented reality in cultural heritage sites: information modeling and user study, *Multimedia Tools and Applications* 76 (2017) 26001–26029. doi:10.1007/s11042-017-4868-6.
- [9] C. Petrucco, D. Agostini, Teaching cultural heritage using mobile augmented reality, *Journal of e-Learning and Knowledge Society* 12 (2016). URL: http://www.je-lks.org/ojs/index.php/Je-LKS_EN/article/view/1180.
- [10] C. Panou, L. Ragia, D. Dimelli, K. Mania, An architecture for mobile outdoors augmented reality for cultural heritage, *ISPRS International Journal of Geo-Information* 7 (2018). URL: <https://www.mdpi.com/2220-9964/7/12/463>. doi:10.3390/ijgi7120463.
- [11] F. Herpich, R. L. M. Guarese, L. M. R. Tarouco, et al., A comparative analysis of augmented reality frameworks aimed at the development of educational applications, *Creative Education* 8 (2017) 1433. URL: <https://www.scirp.org/journal/paperinformation.aspx?paperid=77994>. doi:10.4236/ce.2017.89101.
- [12] L. P. Prieto, Y. Wen, D. Caballero, P. Dillenbourg, Review of augmented paper systems in education: An orchestration perspective, *Journal of Educational Technology & Society* 17 (2014) 169–185.
- [13] M. Bower, C. Howe, N. McCredie, A. Robinson, D. Grover, Augmented reality in education – cases, places, and potentials, in: *2013 IEEE 63rd Annual Conference International Council for Education Media (ICEM)*, 2013, pp. 1–11. doi:10.1109/CICEM.2013.6820176.
- [14] Advantages and challenges associated with augmented reality for education: A systematic review of the literature, *Educational Research Review* 20 (2017) 1–11. doi:10.1016/j.edurev.2016.11.002.
- [15] P. Diegmann, M. Schmidt-Kraepelin, S. Eynden, D. Basten, Benefits of augmented reality in educational environments - a systematic literature review, in: *Wirtschaftsinformatik Proceedings*, 2015, pp. 1542–1556. URL: <https://aisel.aisnet.org/wi2015/103/>.
- [16] N. Rashevskaya, V. Soloviev, Augmented reality and the prospects for applying it in the training of future engineers, *CEUR Workshop Proceedings* 2257 (2018) 192–197.
- [17] M. Ablyayev, A. Abliakimova, Z. Seidametova, Design of mobile augmented reality system for early literacy, *CEUR Workshop Proceedings* 2387 (2019) 274–285. URL: <http://ceur-ws.org/Vol-2387/20190274.pdf>.
- [18] M. Ablyayev, A. Abliakimova, Z. Seidametova, Developing a mobile augmented reality application for enhancing early literacy skills, in: V. Ermolayev, F. Mallet, V. Yakovyna, H. C. Mayr, A. Spivakovsky (Eds.), *Information and Communication Technologies in Education, Research, and Industrial Applications*, Springer International Publishing, Cham, 2020, pp. 163–185.

- [19] P. Nechypurenko, V. Stoliarenko, T. Starova, T. Selivanova, O. Markova, Y. Modlo, E. Shmeltser, Development and implementation of educational resources in chemistry with elements of augmented reality, *CEUR Workshop Proceedings 2547* (2020) 156–167.
- [20] M. E. C. Santos, A. Chen, T. Taketomi, G. Yamamoto, J. Miyazaki, H. Kato, Augmented reality learning experiences: Survey of prototype design and evaluation, *IEEE Transactions on Learning Technologies 7* (2014) 38–56. doi:10.1109/TLT.2013.37.
- [21] T. Kramarenko, O. Pylypenko, V. Zaselskiy, Prospects of using the augmented reality application in STEM-based Mathematics teaching, *CEUR Workshop Proceedings 2547* (2020) 130–144.
- [22] I. Mintii, V. Soloviev, Augmented reality: Ukrainian present business and future education, *CEUR Workshop Proceedings 2257* (2018) 227–231.
- [23] N. Zinonos, E. Vihrova, A. Pikilnyak, Prospects of using the augmented reality for training foreign students at the preparatory departments of universities in Ukraine, *CEUR Workshop Proceedings 2257* (2018) 87–92.
- [24] J. Martin, J. Bohuslava, H. Igor, Augmented Reality in Education 4.0, in: 2018 IEEE 13th International Scientific and Technical Conference on Computer Sciences and Information Technologies (CSIT), volume 1, IEEE, 2018, pp. 231–236. doi:10.1109/stc-csit.2018.8526676.
- [25] M. Marienko, Y. Nosenko, M. Shyshkina, Personalization of learning using adaptive technologies and augmented reality, *CEUR Workshop Proceedings 2731* (2020) 341–356.
- [26] G. Lilligreen, S. Keuchel, A. Wiebel, Augmented reality in higher education: An active learning approach for a course in audiovisual production, in: *EuroVR Conference, 2019*. URL: http://forschung.awmw.org/PDF/lilligreen_EuroVR_2019.pdf.
- [27] M. Wolf, H. Söbke, J. Baalsrud Hauge, *Designing Augmented Reality Applications as Learning Activity*, Springer International Publishing, Cham, 2020, pp. 23–43. doi:10.1007/978-3-030-42156-4_2.
- [28] B. R. Martins, J. A. Jorge, E. R. Zorzal, Towards augmented reality for corporate training, *Interactive Learning Environments* (2021) 1–19. doi:10.1080/10494820.2021.1879872.
- [29] D. S. Shepiliev, S. O. Semerikov, Y. V. Yechkalo, V. V. Tkachuk, O. M. Markova, Y. O. Modlo, I. S. Mintii, M. M. Mintii, T. V. Selivanova, N. K. Maksyshko, T. A. Vakaliuk, V. V. Osadchyi, R. O. Tarasenko, S. M. Amelina, A. E. Kiv, Development of career guidance quests using WebAR, *Journal of Physics: Conference Series 1840* (2021) 012028. URL: <https://doi.org/10.1088/1742-6596/1840/1/012028>. doi:10.1088/1742-6596/1840/1/012028.
- [30] J. Garzón, J. Pavón, S. Baldiris, Augmented reality applications for education: Five directions for future research, in: L. T. De Paolis, P. Bourdot, A. Mongelli (Eds.), *Augmented Reality, Virtual Reality, and Computer Graphics*, Springer International Publishing, Cham, 2017, pp. 402–414.
- [31] I. Radu, Augmented reality in education: a meta-review and cross-media analysis, *Personal and Ubiquitous Computing 18* (2014) 1533–1543. doi:10.1007/s00779-013-0747-y.
- [32] J. Garzón, J. Pavón, S. Baldiris, Systematic review and meta-analysis of augmented reality in educational settings, *Virtual Reality 23* (2019) 447–459. doi:10.1007/s10055-019-00379-9.
- [33] L. T. De Paolis, P. Bourdot (Eds.), *Augmented Reality, Virtual Reality, and Computer Graphics: 5th International Conference, AVR 2018, Otranto, Italy, June 24–27, 2018, Proceedings*,

Part I, volume 10850, Springer, 2018.

- [34] J. M. Mota, I. Ruiz-Rube, J. M. Dodero, I. Arnedillo-Sánchez, Augmented reality mobile app development for all, *Computers & Electrical Engineering* 65 (2018) 250–260. doi:10.1016/j.compeleceng.2017.08.025.
- [35] A.-C. Haugstvedt, J. Krogstie, Mobile augmented reality for cultural heritage: A technology acceptance study, in: *2012 IEEE International Symposium on Mixed and Augmented Reality (ISMAR)*, 2012, pp. 247–255. doi:10.1109/ISMAR.2012.6402563.
- [36] T. Kolomoiets, D. Kassim, Using the augmented reality to teach of global reading of preschoolers with autism spectrum disorders, *CEUR Workshop Proceedings* 2257 (2018) 237–246.
- [37] O. Lavrentieva, I. Arkhypov, O. Krupskiy, D. Velykodnyi, S. Filatov, Methodology of using mobile apps with augmented reality in students' vocational preparation process for transport industry, *CEUR Workshop Proceedings* 2731 (2020) 143–162.
- [38] N. Rashevskia, S. Semerikov, N. Zinonos, V. Tkachuk, M. Shyshkina, Using augmented reality tools in the teaching of two-dimensional plane geometry, *CEUR Workshop Proceedings* 2731 (2020) 79–90.
- [39] M. R. Ablyaev, A. N. Abliakimova, Z. S. Seidametova, Criteria of evaluating augmented reality applications, in: *Advanced Engineering Research*, volume 20, 2020, pp. 414–421. doi:10.23947/2687-1653-2020-20-4-414-421.
- [40] A.-M. Calle-Bustos, M.-C. Juan, F. Abad, R. Mollá, An augmented reality app for therapeutic education and suitable for mobile devices with different features, in: *2019 IEEE 19th International Conference on Advanced Learning Technologies (ICALT)*, volume 2161-377X, 2019, pp. 337–339. doi:10.1109/ICALT.2019.00106.
- [41] Augmented reality sdk comparison, 2021. URL: <https://socialcompare.com/en/comparison/augmented-reality-sdks>.
- [42] S. Baloch, S. Qadeer, K. Memon, Augmented reality, a tool to enhance conceptual understanding for engineering students, *International Journal of Electrical Engineering & Emerging Technology* 1 (2018). URL: <http://www.ijeet.com/index.php/ijeet/article/view/8>.
- [43] B. Dias, B. Keller, S. Delabrida, Evaluation of Augmented Reality SDKs for Classroom Teaching, in: *Proceedings of the 18th Brazilian Symposium on Human Factors in Computing Systems, IHC '19*, Association for Computing Machinery, New York, NY, USA, 2019. doi:10.1145/3357155.3358447.
- [44] T. A. Vakaliuk, S. I. Pochtoviuk, Analysis of tools for the development of augmented reality technologies, *CEUR Workshop Proceedings* (2021).
- [45] M. Mekni, A. Lemieux, Augmented reality: Applications, challenges and future trends, *Applied Computational Science* 20 (2014) 205–214. URL: <http://www.cs.ucf.edu/courses/cap6121/spr2020/readings/Mekni2014.pdf>.
- [46] E. S. Goh, M. S. Sunar, A. W. Ismail, 3d object manipulation techniques in handheld mobile augmented reality interface: A review, *IEEE Access* 7 (2019) 40581–40601. doi:10.1109/ACCESS.2019.2906394.
- [47] A. Evangelista, L. Ardito, A. Boccaccio, M. Fiorentino, A. Messeni Petruzzelli, A. E. Uva, Unveiling the technological trends of augmented reality: A patent analysis, *Computers in Industry* 118 (2020) 103221. doi:10.1016/j.compind.2020.103221.

- [48] E. V. Krikun, Monuments of the Crimean Tatar architecture (XIII-XX centuries), Krymchepedgiz, Simferopol, 1998.
- [49] G. A. Babenko, Masterpieces of Muslim architecture of Crimea, SCT, Simferopol, 2008.

Augmented reality while studying radiochemistry for the upcoming chemistry teachers

Liliia Ya. Midak¹, Ivan V. Kravets¹, Olga V. Kuzyshyn¹, Tetiana V. Kostiuik¹,
Khrystyna V. Buzhdyhan¹, Victor M. Lutsyshyn¹, Ivanna O. Hladkoskok¹,
Arnold E. Kiv² and Mariya P. Shyshkina³

¹Vasyl Stefanyk Precarpathian National University, 57 Shevchenko Str., Ivano-Frankivsk, 76000, Ukraine

²Ben-Gurion University of the Negev, P.O.B. 653, Beer Sheva, 8410501, Israel

³Institute of Information Technologies and Learning Tools of the NAES of Ukraine, 9 M. Berlynskoho Str., Kyiv, 04060, Ukraine

Abstract

The objective of the research is developing a mobile application (on Android) designed to visualize the basic definitions of the discipline “Radiochemistry and radioecology” in 3D. Studying the education material of this discipline (phenomena of radionuclide, radioisotope, the nucleus, the fundamental particle etc and their specifics) requires a more sophisticated explanation from the teacher and dynamic dimensional image from the student. Decent detailed visualization of the study material makes this process easier. So applying the augmented reality is rational for the purpose of visualizing the study material, applying it allows demonstrate 3D-models of the nucleus, the fundamental particles, the nature of radioactive decay, nuclear fission, the specifics of managing the nuclear weapon and the NPS. Involving this instrument of the up-to-date information and communication technologies while studying the new material gives the opportunity to develop and boost the spatial imagination of the students, “to see” the invisible and to understand the received material in a better way, which improves its better memorizing. As far as the augmented reality is one of the most recent new-age education trends, all the teachers are required to have the ability to use it. In this reason the upcoming teachers, the students of the “General Education (Chemistry)” specialty, must be trained with this technology. Within the study process the students have the opportunity to review the positive moments of applying AR from a student’s stand of point and to understand, how to apply similar education tools in the future pedagogic work.

Keywords

augmented reality technology, mobile learning, mobile application, chemistry education, radiochemistry

AREdu 2021: 4th International Workshop on Augmented Reality in Education, May 11, 2021, Kryvyi Rih, Ukraine

✉ lilia.midak@gmail.com (L. Ya. Midak); wanderkori@gmail.com (I. V. Kravets); olgaifua3108@gmail.com (O. V. Kuzyshyn); kostyuk.tatyanaa@gmail.com (T. V. Kostiuik); khrystja.buzhdyhan@gmail.com (K. V. Buzhdyhan); lucyshyn64@gmail.com (V. M. Lutsyshyn); gladkoskokivanka18.01@gmail.com (I. O. Hladkoskok); kiv.arnold20@gmail.com (A. E. Kiv); shyshkina@iitlt.gov.ua (M. P. Shyshkina)

🌐 <https://chemeducation.pnu.edu.ua/5319-2/> (L. Ya. Midak); <https://chemeducation.pnu.edu.ua/kuzyshyn/> (O. V. Kuzyshyn); <https://ieeexplore.ieee.org/author/38339185000> (A. E. Kiv);

<https://iitlt.gov.ua/eng/structure/departments/cloud/detail.php?ID=269> (M. P. Shyshkina)

🆔 0000-0002-3213-5968 (L. Ya. Midak); 0000-0002-6737-6577 (O. V. Kuzyshyn); 0000-0002-0991-2343 (A. E. Kiv); 0000-0001-5569-2700 (M. P. Shyshkina)

© 2021 Copyright for this paper by its authors.
Use permitted under Creative Commons License Attribution 4.0 International (CC BY 4.0).
 CEUR Workshop Proceedings (CEUR-WS.org)

1. Introduction

Comprehensive involvement of information and communication technologies (ICT) within the study process and within managing the education system and the education establishments is the main way to supply effectiveness of the education reform. Applying the ICT into the whole education system will definitely expand the teachers' possibilities, set-up the teacher-student cooperation; build the students' technical skills, which are so important for our century [1].

Reforming the education provides reinforcement of the students' project, team and group activities within the study process. With this being said, the scenarios of organizing the education society will be diverse; the main focus will be on delivering mobile work places that can be reset for group management purposes [2]. Planning and design of the education space will target on the student's development and motivation for study with the instrumentality of ICT, multimedia devices, with upgrading the natural sciences laboratory [1].

Nowadays, children are getting used to availability of data wherever they are, 24 hours per day, 7 days a week. They are also getting used to the Virtual Reality. That is why the so-called SMART education, which requires the use of smartphones, tablets, interactive boards and other devices with Internet access, is becoming more and more popular [1].

The integration of the study process with mobile devices and computers, uniting the real objects with the virtual ones, supplying the necessary information about the studied objects, including their 3D visualizing becomes possible with the augmented reality [3]. That is why, the upcoming teachers, the students of the "General Education (Chemistry)" specialty, must be trained with this technology. Within the study process the students have the opportunity to review the positive moments of applying AR from a student's stand of point and to understand, how to apply similar education tools in the future pedagogic work.

The main features of the augmented reality are integration of both real and virtual objects in the natural environment, real-time operation practice, and interactivity, equalizing the specifics of real and virtual objects [4].

Per definition of Ronald T. Azuma, the Augmented Reality (AR) is one of the types of virtual environment (or virtual reality), that augments the external reality, but does not totally change it. Augmented Reality allows the user see the real world, when virtual objects are either laid over the real world or consolidate with each other [5]. The Augmented Reality can potentially be applied to all the receptors, including the sense of hearing, smell, somatic sense, but the most common augments is the sense of sight.

The augments can help the human to focus on certain elements of the image from the camera; increases understanding of the objects around by means of supplying the appropriate information that is laid on the image with a text message or a visual image.

Within the education sphere augmented reality helps students discover the world, because they can point the camera on the marker-image and get a lot more interesting information, than the two-dimensional picture of the school book or text book [6]. This augments may contain a 3D-model of the object, animation with some explanations of a certain mechanism or phenomena, video manual about an experiment etc [7].

Chemistry is considered to be a complicated science, it operates with the ideas that cannot be understood immediately and require specific images and associations in the students' mind. The controversy of the 2D images leads to the important ideas not received properly. The problems

of space visualization, which are easily resolved with tools like turning around the structure and analyzing the symmetric characteristics, are almost non-resolvable with 2D even for competent students. What even more, a lot of students are visuals [8]. This means, they can memorize an object, they saw, in a better way, comparing with the one they imagine with a two-dimensional picture, teacher's lecture or the paragraph they read in the school-book.

The researches [9, 10, 11] analyze the effectiveness of using ICT while studying chemistry in order to build the students' basic qualities and, especially, with-in the research-based learning. In this case, the augmented reality is the remedy, designed for supplying the correct study material and its proper visualization [1]. With that being said [1], nowadays, there is only a few Ukrainian mobile AR apps designed for studying chemical disciplines [12]. As far as the augmented reality is one of the most recent new-age education trends, all the teachers are required to have the ability to use it. This subject has become crucial nowadays, in the era of distance education [13, 14, 15, 16, 17]. Transition of the education process to the distance ones, when a part of the study material is memorized individually by students, makes applying ICT extremely important both for the purpose of remote cooperation with the students, and for the purpose of demonstrating the study data. The mixed reality in this case makes the irreplaceable assistance for the teacher [18], as far as it allows the student receive the information whenever they are, and at the same time, it does not require access to the computer.

Applying augmented reality while studying chemistry is described in numerous articles [19, 20, 21, 22]. It is emphasized that involving 3D visualization gives the opportunity to make the unseen by the human objects visible (an atom, molecule, chemical bonds etc.) and understandable. This approach makes it easier to learn the structure of the atom, mechanisms of chemical bonds etc. Cai et al. [19] have claimed the rationality of AR technology within the process of lecturing chemistry for the purpose of developing the dimensional thinking of students, their ability to imagine and manipulate three-dimensional molecular structures using as an example the subject "The speciation and structure of substances". On the other hand, Cai et al. [19] note, that visualization of separate questions had a negative result on understanding some of the text data by the pupils. Fjeld et al. [20] notes that the quality of chemical 3D objects in AR has a positive effect on the motivation level of students and the process of memorizing new knowledge. Núñez et al. [21] mark that providing AR-technology increases the motivation for studying chemistry, develops understanding the crystal structure of substances and improves the student's skills of manipulating 2D and 3D patterns. Taçgin et al. [22] states that AR-technologies are the most important technological tools designed for the purpose of demonstration and studying the definitions like "an atom", "a molecule", "a chemical bond" etc., which are invisible for the students.

The augmented reality gives the opportunity to visualize the object to the max (atoms and molecules, their correlations, laboratory device setups, technology processing etc.), meaning to convert the 2D images into 3D, and "make it alive" [23]. That is why it is a must to include the digital acumen into the training of the upcoming chemistry teachers.

The *objective of the research* is developing a mobile application (on Android) designed to visualize the basic definitions of the discipline "Radiochemistry and radioecology" in 3D; they can be used by the teacher and the students in order to study the education material effectively.

2. Methods

As a result of the study, for the purpose of visualizing the study material, a free mobile application “LiCo.Radiochemistry” was developed; it can be downloaded with the QR-code (figure 1). Including the mobile application within the study process is designed to visualize the study material, receive short information about the visualized objects (mini-outline), and to examine the students’ knowledge by means of test control.



Figure 1: QR-code for downloading the mobile app LiCo.Radiochemistry.

3D models of the nucleus, fundamental parts (α , β , γ rays), as well as animation designed to explain the nature of nuclear reactions were developed for the mobile application.

Augmented reality markers were developed [24] on the platform Vuforia; 3D objects were modeled [24] in the 3D Max, augmented reality objects were realized with the multiplatform tool designed for developing 2D and 3D mobile applications Unity 3D [25] (figure 2). All of this was designed to apply the AR technology.

3. Discussion and results

The developed mobile application contains the study material of the discipline “Radiochemistry and radioecology”, learned by the students of the specialty “General Education (Chemistry)” of Vasyl Stefanyk Precarpathian National University during the first year of study and is one of the imperative disciplines. This discipline supplies the basics of ecologic competencies and the key principles of the “green” chemistry.

Learning this subject requires introduction with phenomena of radionuclide, radio-isotope, the nucleus, the fundamental particle etc. Most of these definitions are mostly imaginary for the students and do not have a live visual recognition. Phenomena of nuclear fission and radioactive decay are imaginary as well. While studying the subject “The chain nuclear reaction” the mechanisms of nuclear weapon and the nuclear pile on the nuclear power stations (NPS) are learned theoretically. In this way, studying the education material of this discipline (the definitions, phenomena and their specifics) requires a more sophisticated explanation from the teacher and dynamic dimensional image from the student. Decent detailed visualization of the study material makes this process easier. Unfortunately, the 2D images of the contemporary handbooks in this discipline do not provide the opportunity to visualize the study material in good manner, as well as to supply the exact context of the definitions, demonstrate the reaction mechanisms etc. That is why applying the augmented reality is rational for the purpose of

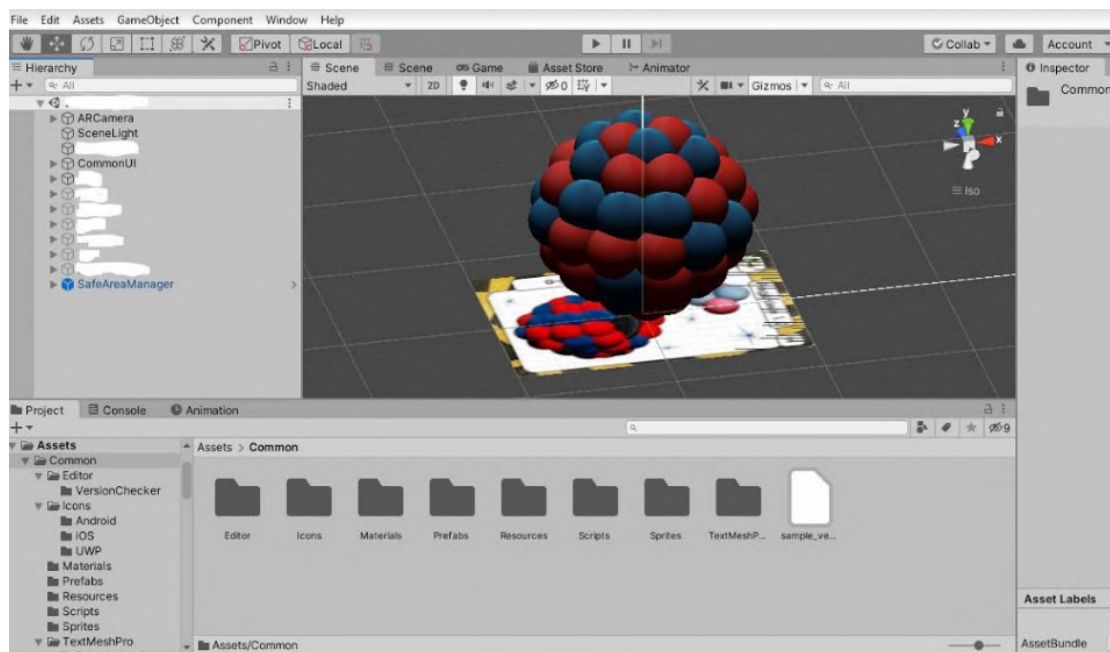

Figure 2: Setting up a 3D model of an atom nucleus in Unity 3D.

visualizing the study material, applying it allows demonstrate 3D models of the nucleus, the fundamental particles, the nature of radioactive decay, nuclear fission, the specifics of managing the nuclear weapon and the NPS. Involving this instrument of the up-to-date information and communication technologies while studying the new material gives the opportunity to develop and boost the spatial imagination of the students, “to see” the invisible and to understand the received material in a better way, which improves its better memorizing. However, the application includes study text content, suitable for memorizing by the modern age students.



Figure 3: Operation modes of the mobile application LiCo.Radiochemistry.

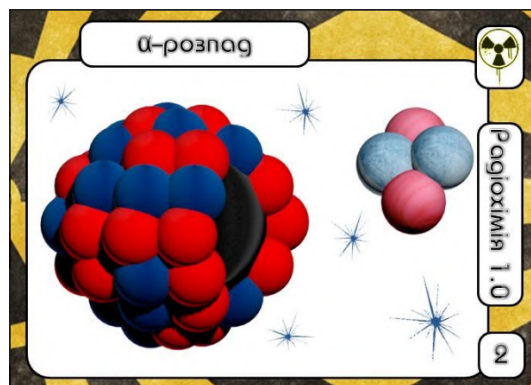

Figure 4: Image marker of the α -decay, viewed with the AR technology in the LiCo.Radiochemistry mobile app.

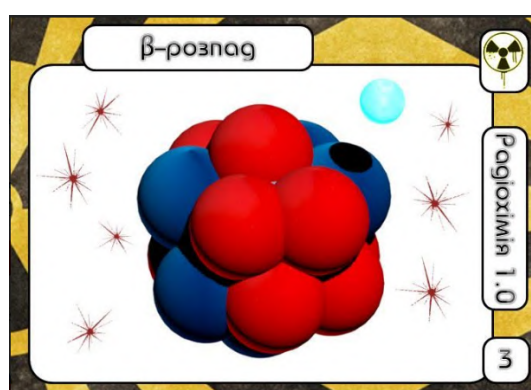

Figure 5: Image marker of the β -decay, viewed with the AR technology in the LiCo.Radiochemistry mobile app.

This ICT tool is also crucial in the remote study days, when the classic explanations of the study info are replaced with on-line lectures and lack of straight communication with students makes it impossible for the teacher to monitor the memorizing the study material.

The developed mobile application operates in three modes, which is its huge advantage: studying the basics of radiochemistry with augmented reality, test control of the knowledge and the vocabulary (figure 3).

The mobile application in AR operates the traditional model: select the image and identify it is a marker → search for the image that goes along with the marker → apply the 3D model on the marker-image → demonstrate it on the device screen.

While working with the augmented reality (AR) mode, the students can look into the external view of the objects and receive short summary about them through a mini-outline. The markers of the mobile app are presented in the figures 4, 5, 6, 7, 8, 9. Through these markers one can receive information about:

- Types and mechanisms of nuclear decay (α -decay, β -decay, γ -rays);
- Specifics of radiation and its correlation with the substance;

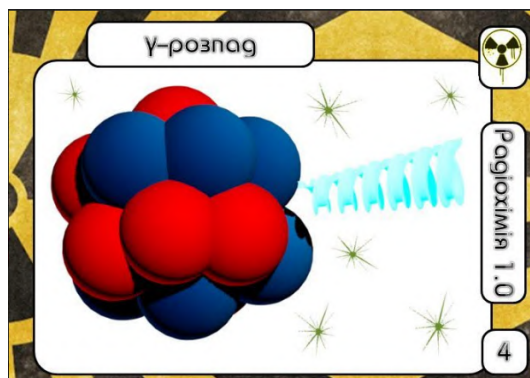

Figure 6: Image marker of the γ -decay, viewed with the AR technology in the LiCo.Radiochemistry mobile app.



Figure 7: Image marker of the chain reaction path, viewed with the AR technology in the Li-Co.Radiochemistry mobile app.

- The nature of chain reaction;
- Principles of nuclear weapon deployment (out-of-control chain reaction);
- Principles of nuclear weapon deployment (controlled chain reaction).

If the smartphone or tablet with the mobile app is pointed on the marker, the image “becomes alive”, the three-dimensional model appears on the screen figure 10, 11, 12, and the image can be manipulated in certain ways (turn-around, zoom-in, view from different angles) in order to better understand its structure, specifics, and for the animations – the nature of the reaction paths.

Mode number two, the testing mode (figure 13, 14) gives students the opportunity to verify their knowledge. The app has selected tests on the topic “Atomic nucleus. Radioactive decay and nuclear transformation” (sub-topic “Radioactivity. Main types of radioactive transformations and its characteristics”). The tests are classified by two complexity levels: two variants of enclosed-type tasks with one correct answer were developed (10 questions per variant).

Mode number three, the vocabulary gives the opportunity to learn and revise the basics on the topic “Atomic nucleus. Radioactive decay and nuclear transformations”.



Figure 8: Image marker of the nuclear weapon pattern, viewed with the AR technology in the LiCo.Radiochemistry mobile app.

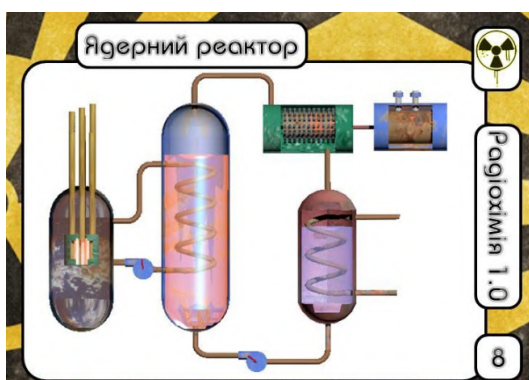

Figure 9: Image marker of the nuclear pile, viewed with the AR technology in the LiCo.Radiochemistry mobile app.

This guidance paper was approved by Vasyl Stefanyk Precarpathian National University while studying the disciplines “Radiochemistry and radioecology” and “The contemporary technologies in chemistry” designed for students of the field of study “General Education (Chemistry)”. Also, with the appropriate explanations the mobile app can be used by physics teachers during their lessons in the 9th grade of school while studying “Physics of the nucleus and physics of the atom. The basics of nuclear energy in physics” and in the 11th grade while studying the subject “Atomic and nuclear physics”.

4. Conclusions

The mobile application (on Android) was developed for the purpose of visualizing the basics of the course “Radiochemistry and radioecology”, it can be used by the teacher and the students in order to understand the study material effectively.

The developed mobile app is a Ukrainian software product, which provides the study material in two forms: graphics (providing the 3D models) and text. Compared to other mobile app, the developed one has also the testing mode, designed to control the knowledge of students.

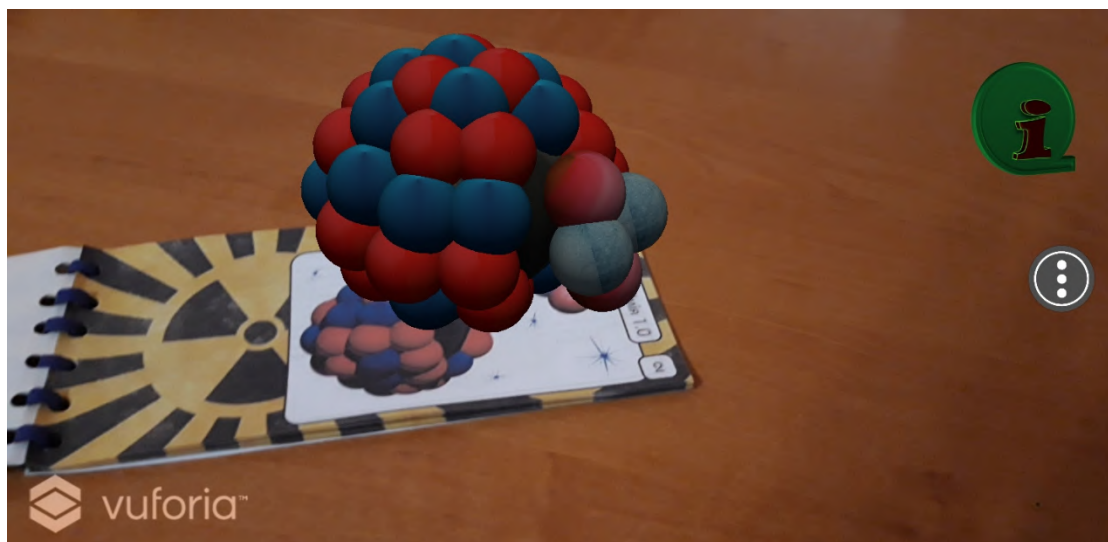

Figure 10: Simulation of the α -decay with the AR technology in the LiCo.Radiochemistry mobile app.

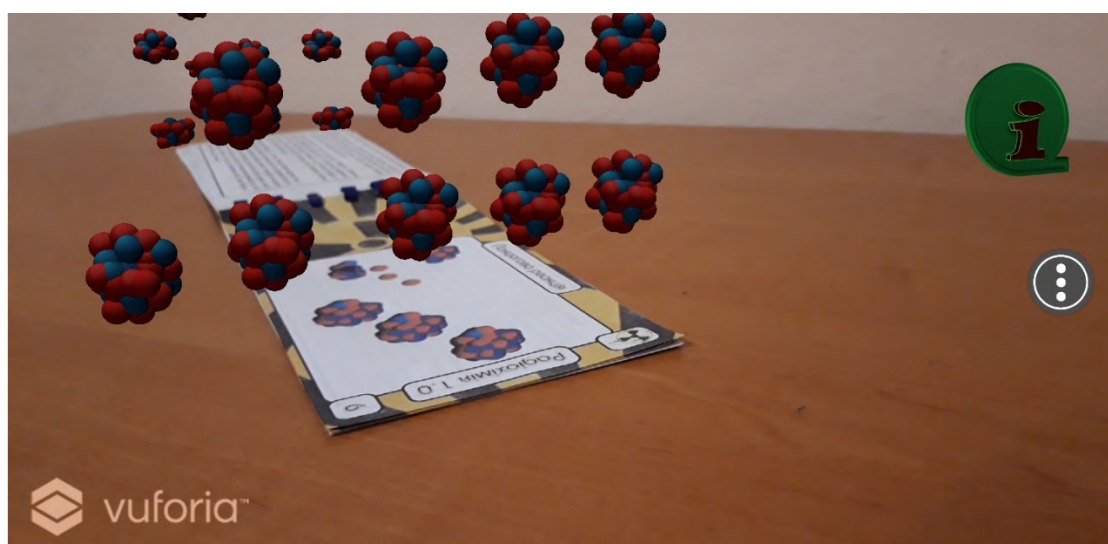

Figure 11: Simulation of the chain reaction path with the AR technology in the LiCo.Radiochemistry mobile app.

Applying the augmented reality objects gives teacher the opportunity to explain the theory, which cannot be illustrated with 2D images appropriately, and to review it live, and the students perceive it effectively.

Studying the education material involving AR gives the upcoming teachers the ability not only to perceive the information in good manner, as a student, but also build the skills to use it



Figure 12: Simulation of the nuclear pile model with the AR technology in the LiCo.Radiochemistry mobile app.



Figure 13: Testing task in the testing mode of the developed mobile app.



Figure 14: Selecting the right answer in the testing mode of the developed mobile app.

in the future pedagogic work during chemistry lessons, get prepared to discover new education technologies and learn throughout the lifetime.

References

- [1] P. Nechypurenko, T. Starova, T. Selivanova, A. Tomilina, A. Uchitel, Use of augmented reality in chemistry education, CEUR Workshop Proceedings 2257 (2018) 15–23.
- [2] Y. Modlo, S. Semerikov, S. Bondarevskiy, S. Tolmachev, O. Markova, P. Nechypurenko, Methods of using mobile Internet devices in the formation of the general scientific component of bachelor in electromechanics competency in modeling of technical objects, CEUR Workshop Proceedings 2547 (2020) 217–240.
- [3] S. Zelinska, A. Azaryan, V. Azaryan, Investigation of opportunities of the practical application of the augmented reality technologies in the information and educative environment for mining engineers training in the higher education establishment, CEUR Workshop Proceedings 2257 (2018) 204–214.
- [4] R. Azuma, Y. Baillet, R. Behringer, S. Feiner, S. Julier, B. MacIntyre, Recent advances in augmented reality, IEEE Comput. Graph. Appl. 21 (2001) 34–47. doi:10.1109/38.963459.
- [5] R. T. Azuma, A survey of augmented reality, Presence: Teleoperators and Virtual Environments 6 (1997) 355–385. doi:10.1162/pres.1997.6.4.355.
- [6] T. Kramarenko, O. Pylypenko, V. Zaselskiy, Prospects of using the augmented reality application in STEM-based Mathematics teaching, CEUR Workshop Proceedings 2547 (2020) 130–144.
- [7] O. Lavrentieva, I. Arkhypov, O. Krupskiy, D. Velykodnyi, S. Filatov, Methodology of using mobile apps with augmented reality in students' vocational preparation process for transport industry, CEUR Workshop Proceedings 2731 (2020) 143–162.
- [8] M. Kolchanova, T. Derkach, T. Starova, Conditions for creating a balance between learning styles on the example of the material of the discipline "Ecological Chemistry and Environmental Monitoring", E3S Web of Conferences 166 (2020) 10028. doi:10.1051/e3sconf/202016610028, 2020 International Conference on Sustainable Futures: Environmental, Technological, Social and Economic Matters, ICSF 2020 ; Conference Date: 20 May 2020 Through 22 May 2020.
- [9] P. P. Nechypurenko, S. O. Semerikov, T. V. Selivanova, T. O. Shenayeva, Information and communication tools for pupils' research competence formation at chemistry profile learning, Information Technologies and Learning Tools 56 (2016) 10–29. URL: <https://journal.iitta.gov.ua/index.php/itlt/article/view/1522>. doi:10.33407/itlt.v56i6.1522.
- [10] P. Nechypurenko, S. Semerikov, VlabEmbed - the new plugin Moodle for the chemistry education, CEUR Workshop Proceedings 1844 (2017) 319–326.
- [11] P. Nechypurenko, V. Soloviev, Using ICT as the tools of forming the senior pupils' research competencies in the profile chemistry learning of elective course "Basics of quantitative chemical analysis", CEUR Workshop Proceedings 2257 (2018) 1–14.
- [12] L. Y. Midak, I. V. Kravets, O. V. Kuzyshyn, L. V. Baziuk, K. V. Buzhdyhan, Specifics of using image visualization within education of the upcoming chemistry teachers with augmented reality technology, Journal of Physics: Conference Series 1840 (2021) 012013. doi:10.1088/1742-6596/1840/1/012013.
- [13] S. Shokaliuk, Y. Bohunenko, I. Lovianova, M. Shyshkina, Technologies of distance learning for programming basics on the principles of integrated development of key competences, CEUR Workshop Proceedings 2643 (2020) 548–562.

- [14] M. Syvyi, O. Mazbayev, O. Varakuta, N. Panteleeva, O. Bondarenko, Distance learning as innovation technology of school geographical education, *CEUR Workshop Proceedings* 2731 (2020) 369–382.
- [15] D. Y. Bobyliev, E. V. Vihrova, Problems and prospects of distance learning in teaching fundamental subjects to future mathematics teachers, *Journal of Physics: Conference Series* 1840 (2021) 012002. doi:10.1088/1742-6596/1840/1/012002.
- [16] K. Polhun, T. Kramarenko, M. Maloivan, A. Tomilina, Shift from blended learning to distance one during the lockdown period using Moodle: test control of students' academic achievement and analysis of its results, *Journal of Physics: Conference Series* 1840 (2021) 012053. doi:10.1088/1742-6596/1840/1/012053.
- [17] I. S. Mintii, T. A. Vakaliuk, S. M. Ivanova, O. A. Chernysh, S. M. Hryshchenko, S. O. Semerikov, Current state and prospects of distance learning development in Ukraine, *CEUR Workshop Proceedings* (2021).
- [18] V. V. Babkin, V. V. Sharavara, V. V. Sharavara, V. V. Bilous, A. V. Voznyak, S. Y. Kharchenko, Using augmented reality in university education for future IT specialists: educational process and student research work, *CEUR Workshop Proceedings* (2021).
- [19] S. Cai, X. Wang, F.-K. Chiang, A case study of augmented reality simulation system application in a chemistry course, *Computers in Human Behavior* 37 (2014) 31–40. doi:10.1016/j.chb.2014.04.018.
- [20] M. Fjeld, J. Fredriksson, M. Ejdestig, F. Duca, K. Bötschi, B. Voegtli, P. Juchli, Tangible user interface for chemistry education: Comparative evaluation and re-design, in: *Proceedings of the SIGCHI Conference on Human Factors in Computing Systems, CHI '07*, Association for Computing Machinery, New York, NY, USA, 2007, p. 805–808. doi:10.1145/1240624.1240745.
- [21] M. Núñez, R. Quirós, I. Núñez, J. B. Carda, E. Camahort, Collaborative augmented reality for inorganic chemistry education, in: *Proceedings of the 5th WSEAS/IASME International Conference on Engineering Education, EE'08*, World Scientific and Engineering Academy and Society (WSEAS), Stevens Point, Wisconsin, USA, 2008, p. 271–277.
- [22] Z. Taçgin, N. Uluçay, E. Özüağ, Designing and developing an augmented reality application: A sample of chemistry education, *Journal of the Turkish Chemical Society, Section C: Chemical Education* 1 (2016) 147–164. URL: <https://dergipark.org.tr/tr/download/article-file/327604>.
- [23] L. Y. Midak, I. V. Kravets, O. V. Kuzyshyn, L. V. Baziuk, K. V. Buzhdyhan, J. D. Pahomov, Augmented reality as a part of STEM lessons, *Journal of Physics: Conference Series* 1946 (2021) 012009. doi:10.1088/1742-6596/1946/1/012009.
- [24] T. Caudell, D. Mizell, Augmented reality: an application of heads-up display technology to manual manufacturing processes, in: *Proceedings of the Twenty-Fifth Hawaii International Conference on System Sciences*, volume ii, 1992, pp. 659–669 vol.2. doi:10.1109/HICSS.1992.183317.
- [25] O. Katsko, N. Moiseienko, Development computer games on the Unity game engine for research of elements of the cognitive thinking in the playing process, *CEUR Workshop Proceedings* 2292 (2018) 151–155.

Review of the course “Development of Virtual and Augmented Reality Software” for STEM teachers: implementation results and improvement potentials

Serhiy O. Semerikov^{1,2,3,4}, Mykhailo M. Mintii¹ and Iryna S. Mintii^{1,3}

¹Kryvyi Rih State Pedagogical University, 54 Gagarin Ave., Kryvyi Rih, 50086, Ukraine

²Kryvyi Rih National University, 11 Vitalii Matusevych Str., Kryvyi Rih, 50027, Ukraine

³Institute of Information Technologies and Learning Tools of the NAES of Ukraine, 9 M. Berlynskoho Str., Kyiv, 04060, Ukraine

⁴University of Educational Management, 52-A Sichovykh Striltsiv Str., Kyiv, 04053, Ukraine

Abstract

The research provides a review of applying the virtual reality (VR) and augmented reality (AR) technology to education. There are analysed VR and AR tools applied to the course “Development of VR and AR software” for STEM teachers and specified efficiency of mutual application of the environment Unity to visual design, the programming environment (e.g. Visual Studio) and the VR and AR platforms (e.g. Vuforia). JavaScript language and the A-Frame, AR.js, Three.js, ARToolKit and 8th Wall libraries are selected as programming tools. The designed course includes the following modules: development of VR tools (VR and Game Engines; physical interactions and camera; 3D interface and positioning; 3D user interaction; VR navigation and introduction) and development of AR tools (set up AR tools in Unity 3D; development of a project for a photograph; development of training materials with Vuforia; development for promising devices). The course lasts 16 weeks and contains the task content and patterns of performance. It is ascertained that the course enhances development of competences of designing and using innovative learning tools. There are provided the survey of the course participants concerning their expectations and the course results. Reduced amounts of independent work, increased classroom hours, detailed methodological recommendations and increased number of practical problems associated with STEM subjects are mentioned as the course potentials to be implemented.

Keywords

virtual reality, VR, augmented reality, AR, STEM teachers

1. Introduction

The technology of AR is well-known for most of people. It was under the close attention of Gartner analysts for many years. On July 2020, the Gartner Hype Cycle for Emerging

AREdu 2021: 4th International Workshop on Augmented Reality in Education, May 11, 2021, Kryvyi Rih, Ukraine

✉ semerikov@gmail.com (S. O. Semerikov); mykhailo.mintii@gmail.com (M. M. Mintii); irina.mintii@kdpu.edu.ua (I. S. Mintii)

🌐 <https://kdpu.edu.ua/semerikov> (S. O. Semerikov);

<https://www.scopus.com/authid/detail.uri?authorId=57205438593> (M. M. Mintii);

<https://kdpu.edu.ua/personal/ismintii.html> (I. S. Mintii)

🆔 0000-0003-0789-0272 (S. O. Semerikov); 0000-0002-0488-5569 (M. M. Mintii); 0000-0003-3586-4311 (I. S. Mintii)

© 2021 Copyright for this paper by its authors.
Use permitted under Creative Commons License Attribution 4.0 International (CC BY 4.0).



CEUR Workshop Proceedings (CEUR-WS.org)

Technologies reflected the increasing attention for such technologies as Augmented Design and Augmented Development (figure 1) [1].

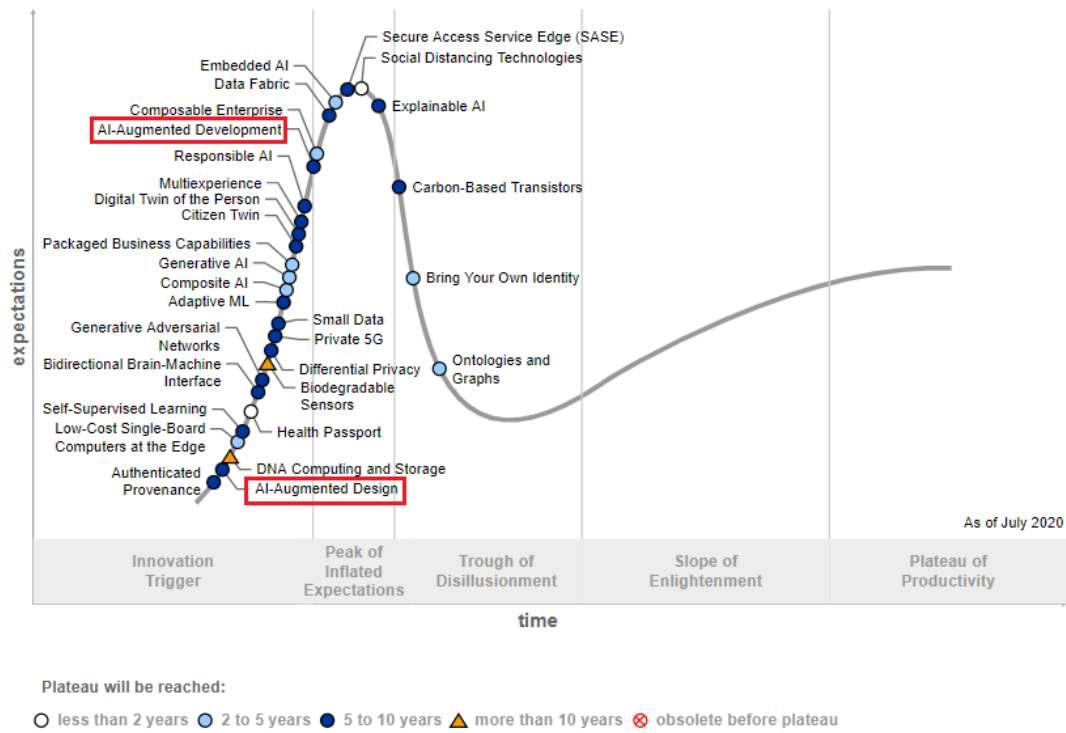

Figure 1: The Gartner Hype Cycle for Emerging Technologies [1].

There are high expectations for AR and VR in education. AR possesses a significant educational potential, first of all, due its ability to visualize objects. In Ukraine, the number of researches into AR/VR application to education has greatly increased in the last few years. Let us mention only publications of 2019-2020 dealing with simulation of ultrasonic wave propagation in the heterogeneous medium using coarse grids (Morkun et al. [2]), studying mathematics, anatomy, physics, chemistry, and architecture (Pochtoviuk et al. [3]), teaching mathematical disciplines to students using in particular the mobile application 3D Calculator with AR of the Dynamic Mathematics GeoGebra system (Kramarenko et al. [4]), studying astrophysics including application of Universe Sandbox2 for space objects simulation (Malchenko et al. [5]), teaching chemistry at higher education institutions, including creation of a database of chemical utensils and a virtual chemical laboratory for qualitative chemical analysis, and formation of training materials for the course “Physical and Colloidal Chemistry” (Nechypurenko et al. [6]).

There is also a review of the content of massive open online courses associated with AR and its application to education in order to create a special course for the professional development system for the research and teaching personnel of postgraduate educational institutions (Panchenko and Muzyka [7]), professional training and retraining (Iatsyshyn et al. [8]), arrange-

ment of welders' simulation training, including a virtual simulation of the welding process by using modern equipment and studies of welders' behavioral reactions (Lavrentieva et al. [9]).

To study a natural cycle, a free mobile application LiCo.STEM is developed (Midak et al. [10]).

There are also investigations into AR/VR application to general technical disciplines including development of a mobile application for accomplishing tasks on a projection drawing (Kanivets et al. [11]), teaching geometry displaying two AR tools – ArloonGeometry and Geometry AR (Rashevskaya et al. [12]), teaching Computer Science at school describing the content of author training for practitioners (Oleksiuk and Oleksiuk [13]), developing a Physical Education teacher's health preserving competence under post-graduate education conditions (Klochko et al. [14]).

As for teaching foreign languages at university, attention is drawn to the use of AR elements in order to support students with different learning styles (audio, visual, kinesthetic) (Tarasenko et al. [15]).

There are researches into vocational training of future transport specialists (Lavrentieva et al. [16]).

AR tools are used in studying vehicles, both civil and military: a new teaching tool containing a spherical (360° or 3D) photographic panorama and a VR device are presented (Barkatov et al. [17]).

In natural and mathematical disciplines, the AR application is developed by means of Android Studio, SDK, ARCore, QR Generator, Math pattern. A number of markers of mathematical objects are developed relevant to the school mathematics course (the topic Polyhedra and Functions, their properties and graphs) (Bilous et al. [18]).

The possibilities of using AR technology are analyzed and the software model of the solar system is created by Hordiienko et al. [19].

To study the subjects of the astronomic cycle at primary school, a mobile application (on the Android platform) is designed to visualize the solar system by using the AR technology as well as the alphabet study with astronomic definitions (Midak et al. [20]).

In education and therapy of people with special needs, AR application is aimed at dealing with cognitive disorders and providing them with communication skills through associations (Dyulichева et al. [21]).

AR tools are also used to provide children with autism spectrum disorders with psychological and pedagogical support (Osadchyi et al. [22]).

Specific attention is paid to the usage of AR books in education (Panchenko et al. [23]), including the integrated course I am exploring the world at primary school, literature classes (Nezhyva et al. [24]) and when training future STEM subject teachers at higher educational institutions [25].

These and other issues were discussed at the 1st [26], 2nd [27], 3rd [28] and 4th International workshops on Augmented Reality in Education (AREdu) [29] which took place in Kryvyi Rih.

Based on the current experience of using VR and AR technologies in education and the prospects for their release into the masses in next 5-10 years, it is necessary to think about the problem of preparing for the use of these innovative technologies in the professional activities of future STEM teachers. After all, in just a few years, today's students will have to manage this process: both as software engineers and as teachers. Therefore, the main purpose of our

research is to develop a training course on designing VR and AR systems for future STEM teachers, adapted to Ukrainian users and to the current level of technology development.

2. The research tasks

The object of the research is the professional training of future STEM teachers for the design of VR and AR technologies.

The subject of the research is the learning resources for the design of VR and AR systems for future STEM teachers.

The purpose of the research is to develop the learning resources for the design of VR and AR systems adapted for different types of learners.

To achieve the purpose of the research such tasks were solved:

- 1) an analysis of the experience of using AR tools for the development of educational materials was done;
- 2) the software for the design of AR tools for educational purposes were identified and the technological requirements for the course “Development of VR and AR software tools” were characterized;
- 3) individual components of the training complex for the design of VR and AR systems for future teachers majoring in STEM disciplines were developed.

3. Results and discussion

Hereafter, we treat AR as an ability of a device (a mobile device or a web-browser) to track an image or display a 3D object over this image. The main idea of AR involves displaying a computer model in real-time and real-space in order to establish interaction between a user in real-space and a 3D model in the virtual one.

AR can be both marker and marker-free. In case of the marker AR, the device tracks a 2D-marker: when it is detected, it actually displays a 3D object. In the marker-free version, a device searches for a flat surface (a table, a floor, etc.) and places a 3D object there.

Using a device camera, AR enables displaying a computer-generated objects in game, marketing and other programmes, for example to arrange furniture in a living room or to try clothes on before buying them. It is really a great opportunity for business, as AR displays products before a consumer actually buys them.

There are specific devices developed for AR including AR helmets and sets that enable users' immersion in the simulated environment.

AR provides the real-life world with 3D models controlled by mobile devices any place. Virtual Reality (VR) plunges a user into a simulated world by using head mounted devices (HMD). Both AR and VR provide interactivity in a similar way. For example, VR actually uses controllers and in some cases, hand tracking that enable a user to interact with 3D objects inside a scene they are located in. Main threats of HMD application to working with VR include eye strain, dizziness and headaches. Unlike VR, AR is not noted for such serious health risks. Nevertheless, users' long concentration on their actions while using AR is causing some disturbances as it is not quite safe [30].

While solving the first problem, it was found out that at the present stage of development of information technologies, the leading means of implementing AR are mobile Internet devices – multimedia mobile devices that provide wireless access to information and communication Internet services for the collection, systematization, storage, processing, transmission, presenting all kinds of messages and data.

While solving the first problem, it was found out that at the present stage of development of information technologies, the leading means of implementing AR are mobile Internet devices – multimedia mobile devices that provide wireless access to information and communication Internet services for the collection, systematization, storage, processing, transmission, presenting all kinds of messages and data.

The use of AR technology in a mobile-oriented learning environment of higher education institutions:

- expands the capabilities of laboratory facilities used to prepare students for work with real systems;
- makes complex and expansive systems available;
- contributes to the improvement of vocational training by providing laboratory simulators with AR;
- motivates students for experimental and educational research work.

The creating of interactive training materials with the use of AR systems can be done in two main directions:

- 1) the use of utilities or linking markers with user-developed models;
- 2) the development of VR and AR software for educational purposes.

In the first direction, the developer does not require good programming skills, however, the functionality of the created tools is significantly limited by the relation to proprietary software. In the second direction, the developer needs develop tools himself. However, the functionality and adaptability of the developed tools are significantly increased.

To solve the second purpose of the study, we reviewed the tools for developing VR and AR and chose the most suitable for achieving the goal of the study. Among the reviewed, we note both the “old” Wikitude SDK [31] (since 2008) and the relatively new (since 2017) Apple tool – SDK ARKit [32].

The current version of *ARKit* allows you to develop multiplayer games with AR *ARCore* [33] is a relatively new (March 2018) tool from Google, a kind of response to ARKit. Supported platforms: Android 7.0 and above, iOS 11 and above.

ARCore comes with three main possibilities of combining VR and real worlds: 1) tracking the position of the phone in the environment; 2) “recognizing the environment” provides the ability of the phone to determine the size and location of horizontal surfaces; 3) lighting assessment allows the phone to evaluate the actual lighting conditions.

ARtoolKit [34] is the oldest (since 1999) SDK for the development of AR tools. It is available on Android, iOS, Linux, Windows, Mac OS, smart glasses.

Maxst [35] is the South Korean SDK. It offers advanced tools for recognizing images and environments. Maxst is freely distributed for non-commercial use, and the free version differs from the paid version only with a watermark.

Vuforia [36] is one of the most popular platforms for developing AR. SDK implements the following functionalities: recognition of various types of visual objects (box, cylinder, plane), recognition of text and surroundings, VuMark (combination of image and QR code). Using the Vuforia Object Scanner, you can scan and create marker objects. The recognition process can be implemented using a database (local or cloud storage). Unlike other SDKs, Vuforia supports both 2D and 3D markers, including Image Target markerless, three-dimensional Multi-Target, as well as benchmark markers that select objects in the scene for recognition.

In our opinion, in the process of preparing future STEM teachers for the use of AR systems for developing interactive teaching materials it is advisable to use an integrated approach. The design with use of standard objects can be performed in a visual design environment. Providing standard objects with new properties and creating new ones can be performed in an object-oriented programming environment. At the present stage of ICT development, it is advisable to use the Unity environment [37] for visual design, Visual Studio [38] or a similar programming environment, as well as virtual platforms (Google VR or the like) and AR (Vuforia or the like).

AR programming has become innovative (trendy, interesting, useful, etc.) in the recent 60 years, usage of JavaScript as a programming language being an exclusively recent trend. However, language choice also determines choice of development tools, the most efficient of which nowadays being the following:

- a) A-Frame and AR.js are application programming interfaces (API) and unique tools of fast prototyping. The HTML-like code, which uses JavaScript on the server, constitutes the major part of their application software. A-Frame is applied to creating scenes, objects, animation and other 3D elements in the web-browser. AR.js enables tracking a marker and displaying a scene designed by A-Frame on the marker;
- b) Three.js and ARToolKit are a so-called backbone applied by many JavaScript libraries. Three.js uses WebGLRenderer to create high-quality 3D scenes directly in the browser. Unlike A-Frame, Three.js is mostly used to create web-programmes under Google Cardboard control and requires JavaScript application.

AR software tools developed with JavaScript and WebGL can be placed on the Internet at one of cloud services like Heroku.

Everything concerning JavaScript/ECMAScript syntax can be found in numerous sources, for instance, video-lectures by Douglas Crockford (<https://youtu.be/playlist?list=PLEzQf147-uEpvTa1bHDNlxUL2kIHUMHJu>).

A-Frame uses the ECS pattern for designing computer games, Entity-Component-System being its basic concepts. The Entity is a container for components. Entities are the basis of all the objects in a scene, yet without components, entities are unable to do or provide anything. The Component is a small object that implements a certain data structure and is responsible for a separate part of software logic. Each component type can be attached to the entity to provide the latter with some property. Systems control sets of entities combined by some components, which are not obligatory. In A-Frame, this design template is realized by attributes.

Any primitives of A-Frame (a-scene, a-box, a-sphere, etc.) are used as entities. a-entity is of special importance being self-explanatory. All other primitives are actually covers for

components and developed for convenience sake as any element can be created by means of a-entity. A-Frame is constantly being supplemented with new components designed by users and packed in npm, which is available at <https://www.npmjs.com/search?q=aframe-component>. To apply a component from the list, you should go to its repository, download and install a corresponding file. Another option is to use the unpkg service to download any npm file following the link `unpkg.com/:package@:version/:file`.

8th Wall is one of the commercial suppliers of AR services that can be used under some functional conditionally free mode. 8th Wall Web is a JavaScript library that implements the technology of simultaneous localization and mapping (SLAM). It is widely used in unmanned vehicles, flying devices, autonomous underwater apparatuses, rovers, household robots, etc. 8th Wall Web easily integrates with such libraries as A-Frame, Three.js, Babylon.js (<https://www.babylonjs.com/>) and Amazon Sumerian (<https://aws.amazon.com/sumerian/>). In the same way as awe.js, 8th Wall Web requires the HTTPS browser to access a web-camera. Mobile browsers require support of:

- WebGL (`canvas.getContext('webgl') || canvas.getContext('webgl2')`);
- getUserMedia (`navigator.mediaDevices.getUserMedia`);
- deviceorientation (`window.DeviceOrientationEvent`);
- Web-Assembly/WASM (`window.WebAssembly`).

The elective course “Development of virtual and AR software” has resulted from solution of the third research problem. The substantive basis this course is the open course from the University of San Diego on the EdX platform [39] and the book by Jesse Glover [40].

The course consists of two substantive modules.

Content module 1. Development of VR tools

- Topic 1.1. VR and Game Engines
- Topic 1.2. Physical interactions and camera
- Topic 1.3. 3D interface and positioning
- Topic 1.4. 3D user interaction
- Topic 1.5. VR navigation and introduction

Content module 2. Development of AR tools

- Topic 2.1. Set up AR tools in Unity 3D
- Topic 2.2. Development of a project for a photograph
- Topic 2.3. Development of training materials with Vuforia
- Topic 2.4. Development for promising devices

The tasks vary in complexity, its level increasing step-by-step. For instance, the first task includes creating the scene described theoretically and disposing its file at students' own site section (e.g., <https://playground2.ccjournals.eu>) as well as sending hyperlinks as answers to check and creating a scene with Ukrainian texture and signs and students' own names (figure 2).

Next, students are to create an AR scene described theoretically (figure 3) and a VR model supplementing it with all the Solar system planets (figure 4).

The 5th week task includes attaching three arbitrary A-Frame objects to markers Hiro, Kanji and one's own marker, placing required files at one's own site section at <https://playground2>.



Figure 2: Performance pattern of the 2nd week task.

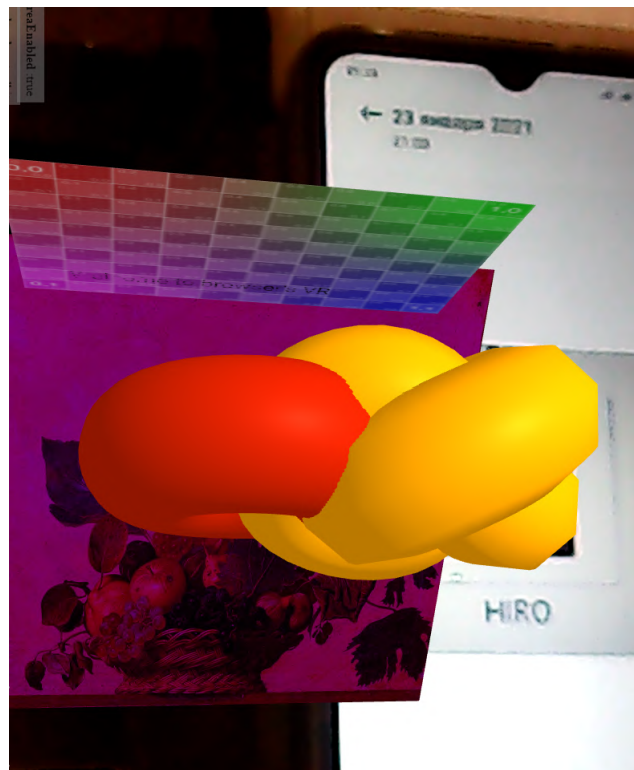

Figure 3: Performance pattern of the 3rd week task.

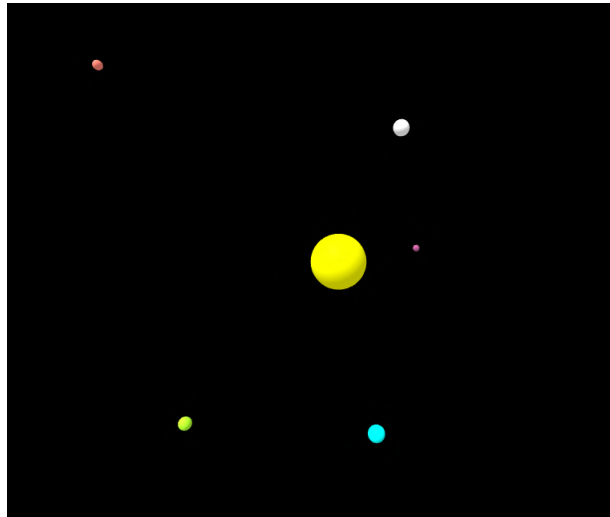

Figure 4: Performance pattern of the 4th week task.

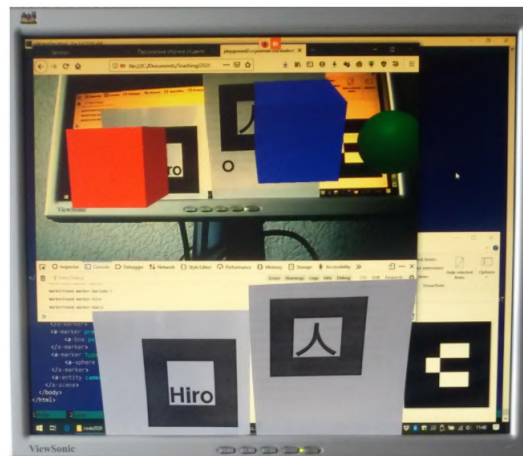

Figure 5: Performance pattern of the 5th week task.

ccjournals.eu and sending a hyperlink for the scene and the designed marker (figure 5) as an answer.

The task of the 6th week is to modify the scene described theoretically to build a pentagon on the markers with letters A, B, C, D, and F (figure 6).

The task of the 7th week involves creation of the empty scene described theoretically by using Three.js (figure 7). After that, students should perform Laboratory Work 1 – create a scene in VR and AR.

During the 8th week, students are to create a dynamic scene described theoretically (figure 8).

Next, students create a dynamic scene using users' shaders as the 9th week task (figure 9) and then the dynamic scene is disposed in the files by using at least three camera helpers (figure 10)

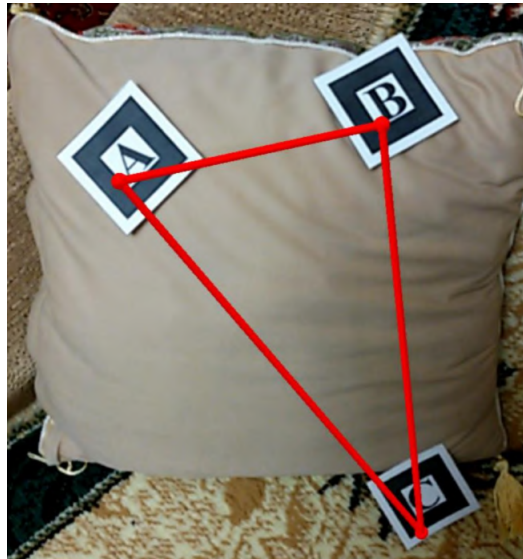

Figure 6: Performance pattern of the 6th week task.

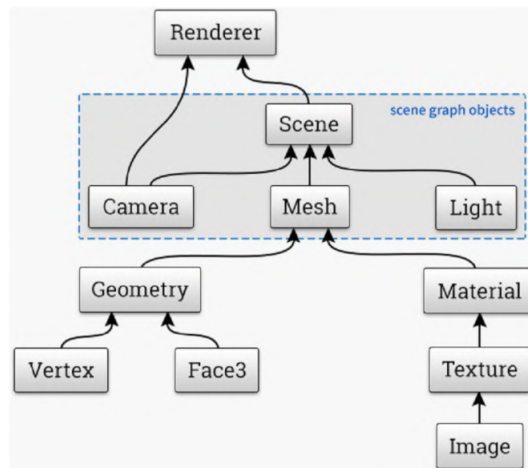

Figure 7: Three.js app model.

as the 10th week task.

During the 11th week, students develop a 360-degree scene (figure 11) and put the model in it (figure 12) during the 12th week.

The 13th week task includes: a) realizing a pattern from theoretical materials using the marker with the number of the two latest last numbers of the hyperlink for the personal section of <https://playground2.ccjournals.eu> site; b) downloading the model of the previous task into the scene from awe.js (figure 13).

The 14th week task implies creation of a scene from the laboratory work 1 using the materials of weeks 7-13 and one's own data of the laboratory work as well as Three.js and awe.js (figure 14).

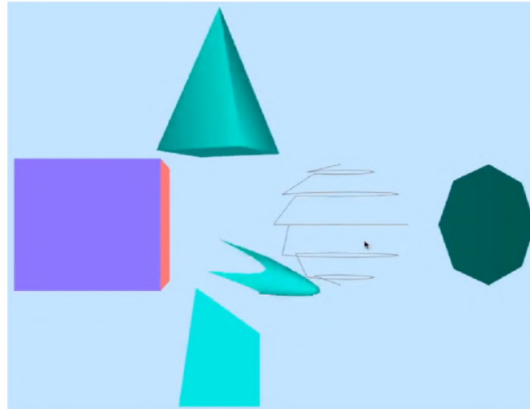

Figure 8: Performance pattern of the 8th week task.



Figure 9: Performance pattern of the 9th week task.

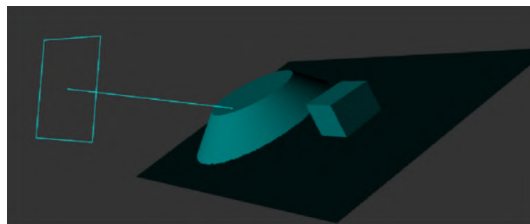

Figure 10: Performance pattern of the 10th week task.

During 15-16 weeks of study, students fulfill the tasks of laboratory work 2 including transferring the scene from laboratory work 1 to 8th Wall using the 8-frame library.

During 2020 80 students were involved in the experiment: POKT-18m and PO-16 groups of Faculty of Information Technology of the Kryvyi Rih National University and MIM-14 and FIM-14 groups of Faculty of Physics and Mathematics of the Kryvyi Rih State Pedagogical University.

So, among the participants in the experiment, a survey was conducted on the formation of competence in the design and use of innovative learning tools.

Survey results are shown in figure 15.

A survey was conducted after the course to obtain feedback on the impressions of the participants. The research data were collected using interview techniques in qualitative data

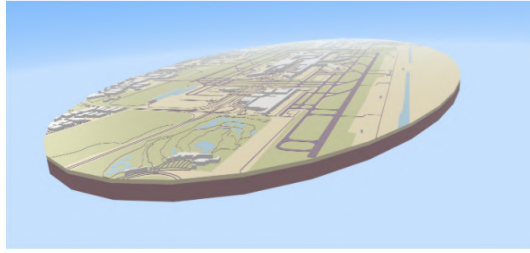

Figure 11: Performance pattern of the 11th week task.

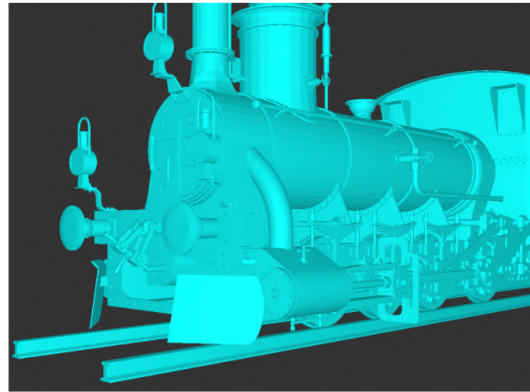

Figure 12: Performance pattern of the 12th week task.



Figure 13: Performance pattern of the 13th week task.

collection method. The survey was attended by 23 participants. It should be noted that at the time of the interview all of them were no longer students, but STEM teachers, which allows us to conclude that the responses received are independent. Gender distributions of the interviewees were three men and twenty women.

Interview questions:

1. Have you had any experience with AR before studying the course?
2. What was the most interesting thing to know?

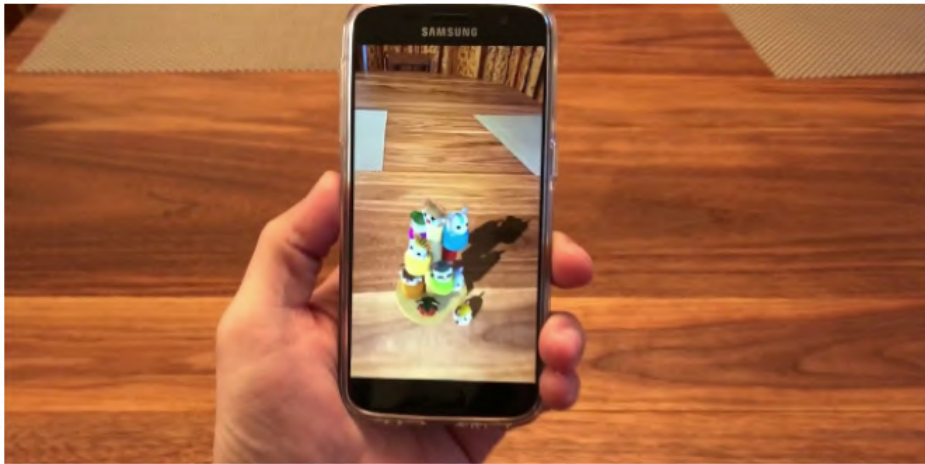

Figure 14: Performance pattern of the 14th week task.

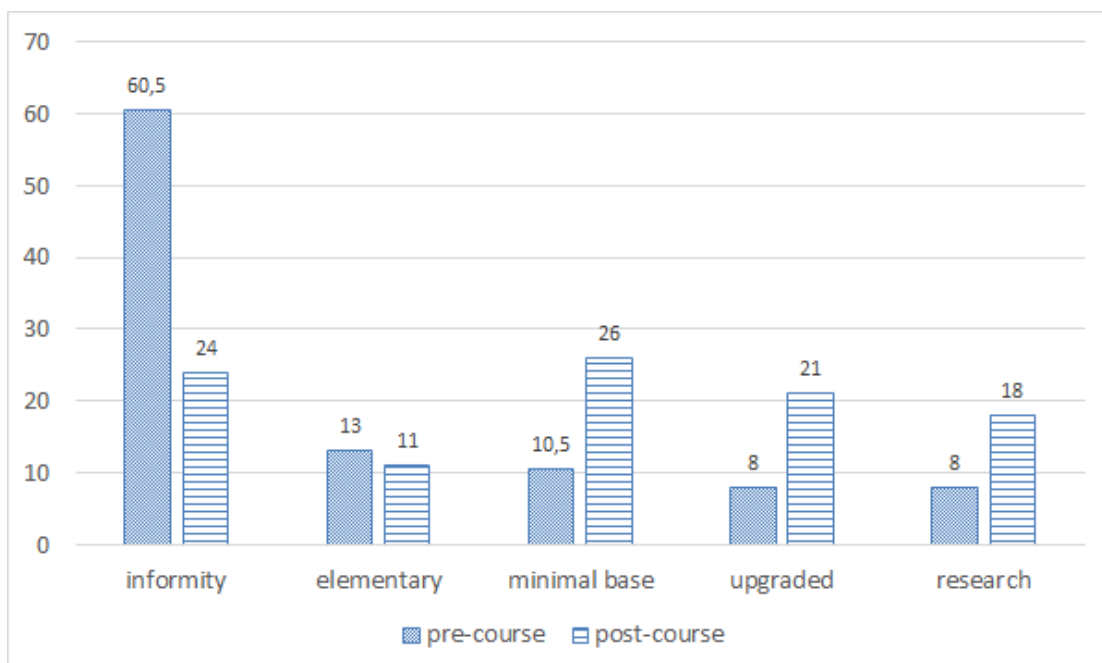

Figure 15: Pre-course and post-course placement.

3. Would you like to improve your knowledge of AR?
4. Do you use augmented reality in your professional activities?
5. What would you suggest to change to make the course more effective?

The content analysis method was used to analyze the interview data. Data analysis includes

the editing, structuring, and interpretation of collected data.

1. Have you had any experience with augmented reality before studying the course?

Initially, the following answers to this question were supposed:

- Yes, I have developed applications myself.
- Yes, I used training applications.
- Yes, I used in everyday life (advertising, entertainment, etc.).
- No, I haven't.

As a result, only 4 of those respondents used AR earlier, and only in everyday life, the remaining 19 before the course had no idea about AR (figure 16).

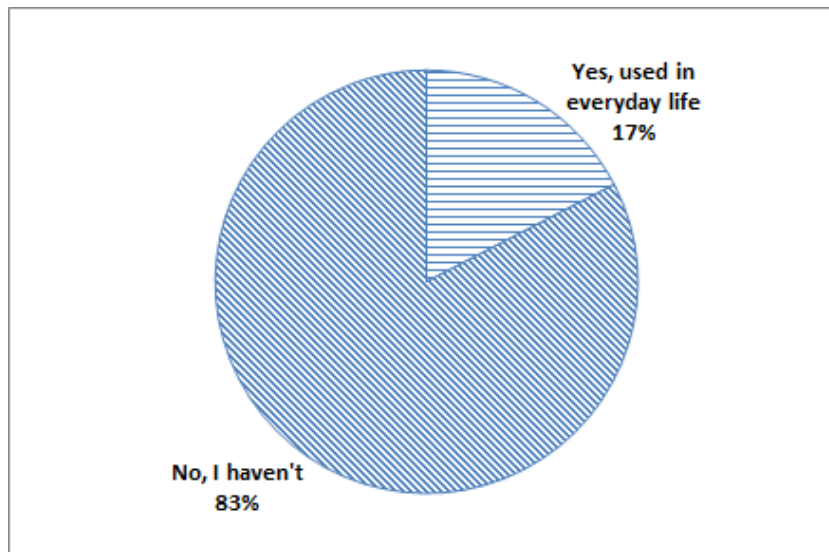

Figure 16: Answers to the question “Have you had any experience with augmented reality before studying the course?”

2. What was the most interesting thing to know?

The meaning of 100% of respondents' answers was either to the process of development or the result of application development or the practical application of these applications.

All received answers were the application development; process of reviving pictures; convert 2D images to 3D; 3D modeling; practical application; visualization.

The most impressive answer was: “Results exceed all expectations”.

3. Would you like to improve your knowledge of AR?

To this question 2 respondents gave a negative answer, 1 was difficult to answer, 15 answered in the affirmative, and 5 said that they have already improved their knowledge. Figure 17 shows the distribution of responses as a percentage.

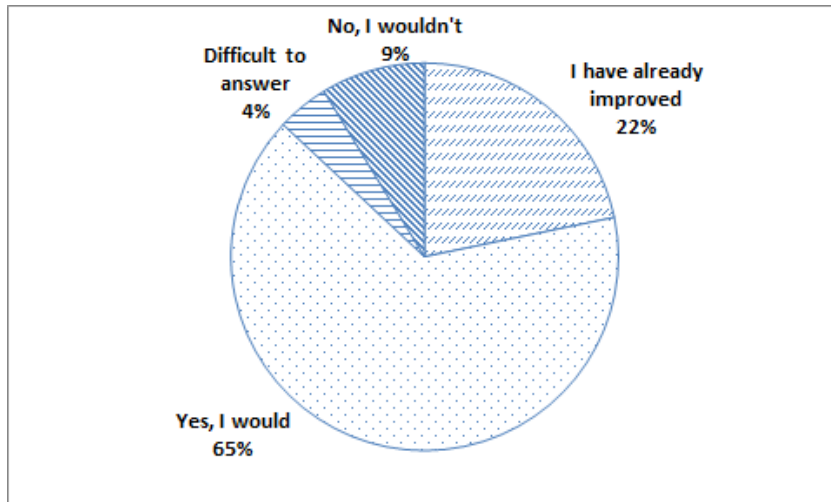

Figure 17: Answers to the question “Would you like to improve your knowledge?”

4. *Do you use AR in your professional activities?*

All the received answers are:

- I’m already using it.
- I’m going to use.
- I think I will use it.
- No, I don’t (figure 18).

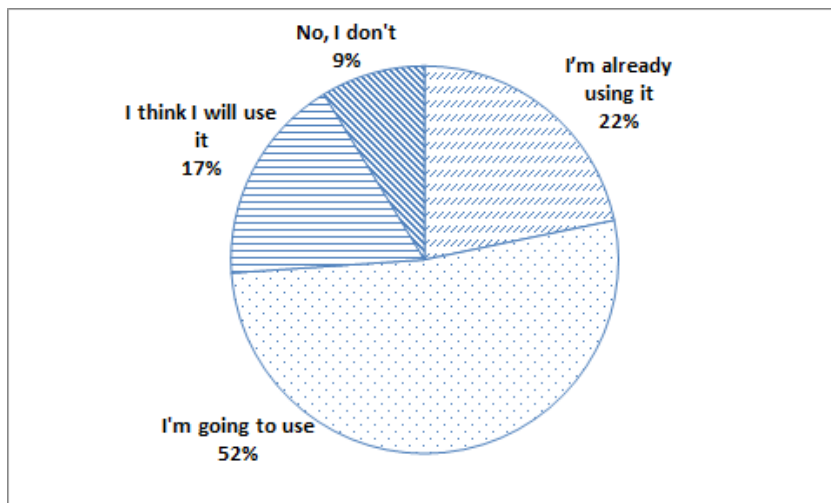

Figure 18: Answers to the question “Do you use AR in your professional activities?”

Respondents identified areas for using AR, such as a master class on the use of augmented

reality for school teachers, when learning to program with high school students, when learning mathematics in specialized classes.

One respondent immediately after the course during preparation for the state exam. One of the questions on the exam was “Demonstration of a fragment of a non-standard lesson”. The theme of the lesson was “Creating logos. Brandguide. Brand book”.

5. *What would you suggest to change to make the course more effective?*

The answers we’ve received:

- Reduce independent work.
- Increase classroom activities (lectures, labs, consultations).
- Extend the course for 2 semesters.
- Detail the methodological guidelines.
- Increase the number of practical tasks connected with STEM courses.
- The idea of conducting a survey using AR markers was interesting.

4. Conclusion

To get a complete picture of students’ impressions of the course, it is necessary to reproduce exactly the answers of some students.

Before the course, I had no idea what AR was. We enjoyed both the process and the result. And the result exceeded all expectations. The organization of the course was excellent. The presentation of the material in the lectures was available and dosed, the tasks in the laboratory classes were clear and had practical meaning.

I use and plan to use received knowledge in the future because the AR is not only popular, but it also increases the level of understanding of the material, and what the most important is it helps to interest the student!

Thus, the course “Development of VR and AR software” promotes the development of competence in the design and using innovative learning tools. The research is not completed, the implementation of the developed course and experimental verification of its effectiveness has been continuing.

References

- [1] K. Costello, M. Rimol, Gartner identifies five emerging trends that will drive technology innovation for the next decade, 2020. URL: <https://tinyurl.com/y49j7y8w>.
- [2] V. Morkun, N. Morkun, A. Pikilnyak, Augmented reality as a tool for visualization of ultrasound propagation in heterogeneous media based on the k-space method, CEUR Workshop Proceedings 2547 (2020) 81–91.
- [3] S. Pochtoviuk, T. Vakaliuk, A. Pikilnyak, Possibilities of application of augmented reality in different branches of education, CEUR Workshop Proceedings 2547 (2020) 92–106.

- [4] T. Kramarenko, O. Pylypenko, V. Zaselskiy, Prospects of using the augmented reality application in STEM-based mathematics teaching, *CEUR Workshop Proceedings 2547* (2020) 130–144.
- [5] S. Malchenko, D. Mykoliuk, A. Kiv, Using interactive technologies to study the evolution of stars in astronomy classes, *CEUR Workshop Proceedings 2547* (2020) 145–155.
- [6] P. Nechypurenko, V. Stoliarenko, T. Starova, T. Selivanova, O. Markova, Y. Modlo, E. Shmeltser, Development and implementation of educational resources in chemistry with elements of augmented reality, *CEUR Workshop Proceedings 2547* (2020) 156–167.
- [7] L. Panchenko, I. Muzyka, Analytical review of augmented reality MOOCs, *CEUR Workshop Proceedings 2547* (2020) 168–180.
- [8] A. Iatsyshyn, V. Kovach, Y. Romanenko, I. Deinega, A. Iatsyshyn, O. Popov, Y. Kutsan, V. Artemchuk, O. Burov, S. Lytvynova, Application of augmented reality technologies for preparation of specialists of new technological era, *CEUR Workshop Proceedings 2547* (2020) 181–200. URL: <https://www.scopus.com/inward/record.uri?eid=2-s2.0-85079569871&partnerID=40&md5=fb71ae21d28037f6a8a3c47d5ecf48e6>.
- [9] O. Lavrentieva, I. Arkhypov, O. Kuchma, A. Uchitel, Use of simulators together with virtual and augmented reality in the system of welders' vocational training: Past, present, and future, *CEUR Workshop Proceedings 2547* (2020) 201–216.
- [10] L. Midak, I. Kravets, O. Kuzyshyn, J. Pahomov, V. Lutsyshyn, A. Uchitel, Augmented reality technology within studying natural subjects in primary school, *CEUR Workshop Proceedings 2547* (2020) 251–261.
- [11] O. Kanivets, I. Kanivets, N. Kononets, T. Gorda, E. Shmeltser, Development of mobile applications of augmented reality for projects with projection drawings, *CEUR Workshop Proceedings 2547* (2020) 262–273.
- [12] N. Rashevskaya, S. Semerikov, N. Zinonos, V. Tkachuk, M. Shyshkina, Using augmented reality tools in the teaching of two-dimensional plane geometry, *CEUR Workshop Proceedings 2731* (2020) 79–90.
- [13] V. Oleksiuk, O. Oleksiuk, Exploring the potential of augmented reality for teaching school computer science, *CEUR Workshop Proceedings 2731* (2020) 91–107.
- [14] O. Klochko, V. Fedorets, A. Uchitel, V. Hnatyuk, Methodological aspects of using augmented reality for improvement of the health preserving competence of a Physical Education teacher, *CEUR Workshop Proceedings 2731* (2020) 108–128.
- [15] R. Tarasenko, S. Amelina, Y. Kazhan, O. Bondarenko, The use of AR elements in the study of foreign languages at the university, *CEUR Workshop Proceedings 2731* (2020) 129–142.
- [16] O. Lavrentieva, I. Arkhypov, O. Krupskyi, D. Velykodnyi, S. Filatov, Methodology of using mobile apps with augmented reality in students' vocational preparation process for transport industry, *CEUR Workshop Proceedings 2731* (2020) 143–162.
- [17] I. Barkatov, V. Farafonov, V. Tiurin, S. Honcharuk, V. Barkatov, H. Kravtsov, New effective aid for teaching technology subjects: 3D spherical panoramas joined with virtual reality, *CEUR Workshop Proceedings 2731* (2020) 163–175.
- [18] V. Bilous, V. Proshkin, O. Lytvyn, Development of AR-applications as a promising area of research for students, *CEUR Workshop Proceedings 2731* (2020) 205–216.
- [19] V. Hordiienko, G. Marchuk, T. Vakaliuk, A. Pikilnyak, Development of a model of the solar system in AR and 3D, *CEUR Workshop Proceedings 2731* (2020) 217–238.

- [20] L. Midak, I. Kravets, O. Kuzyshyn, K. Berladyniuk, K. Buzhdyhan, L. Baziuk, A. Uchitel, Augmented reality in process of studying astronomic concepts in primary school, CEUR Workshop Proceedings 2731 (2020) 239–250.
- [21] Y. Dyulicheva, Y. Kosova, A. Uchitel, The augmented reality portal and hints usage for assisting individuals with autism spectrum disorder, anxiety and cognitive disorders, CEUR Workshop Proceedings 2731 (2020) 251–262.
- [22] V. Osadchyi, H. Varina, K. Osadcha, O. Prokofieva, O. Kovalova, A. Kiv, Features of implementation of modern AR technologies in the process of psychological and pedagogical support of children with autism spectrum disorders, CEUR Workshop Proceedings 2731 (2020) 263–282.
- [23] L. Panchenko, T. Vakaliuk, K. Vlasenko, Augmented reality books: Concepts, typology, tools, CEUR Workshop Proceedings 2731 (2020) 283–296.
- [24] L. Nezhyva, S. Palamar, O. Lytvyn, Perspectives on the use of augmented reality within the linguistic and literary field of primary education, CEUR Workshop Proceedings 2731 (2020) 297–311.
- [25] S. Semerikov, S. Lytvynova, M. Mintii, Implementation of the course development of virtual and ar software for stem teachers, Modern information technologies and innovative teaching methods in training: methodology, theory, experience, problems 57 (2020) 55–63.
- [26] S. Semerikov, M. Shyshkina, Preface, CEUR Workshop Proceedings 2168 (2017).
- [27] A. Kiv, M. Shyshkina, S. Semerikov, A. Striuk, Y. Yechkalo, AREdu 2019 – How augmented reality transforms to augmented learning, CEUR Workshop Proceedings 2547 (2020) 1–12.
- [28] O. Burov, A. Kiv, S. Semerikov, A. Striuk, M. Striuk, L. Kolgatina, I. Oliinyk, AREdu 2020 - How augmented reality helps during the coronavirus pandemic, CEUR Workshop Proceedings 2731 (2020) 1–46.
- [29] S. H. Lytvynova, S. O. Semerikov, A. M. Striuk, M. I. Striuk, L. S. Kolgatina, V. Y. Velychko, I. S. Mintii, O. O. Kalinichenko, S. M. Tukalo, AREdu 2021 – Immersive technology today, CEUR Workshop Proceedings (2021).
- [30] D. S. Shepiliev, Y. O. Modlo, Y. V. Yechkalo, V. V. Tkachuk, M. M. Mintii, I. S. Mintii, O. M. Markova, T. V. Selivanova, O. M. Drashko, O. O. Kalinichenko, T. A. Vakaliuk, V. V. Osadchyi, S. O. Semerikov, WebAR development tools: An overview, CEUR Workshop Proceedings 2832 (2020) 84–93. URL: <http://ceur-ws.org/Vol-2832/paper12.pdf>.
- [31] Wikitude Cross-Platform Augmented Reality SDK - Boost your app, 2013. URL: <https://www.wikitude.com/products/wikitude-sdk/>.
- [32] ARKit 3 – Augmented Reality | Apple Developer, 2019. URL: <https://developer.apple.com/augmented-reality/arkit/>.
- [33] ARCore – Google Developers | Google Developers, 2017. URL: <https://developers.google.com/ar>.
- [34] ARToolKit Home Page, 2003. URL: <http://www.hitl.washington.edu/artoolkit/>.
- [35] MAXST | Technology company specialized in AR, 2006. URL: <http://maxst.com/#/>.
- [36] Vuforia: Market-Leading Enterprise AR | PTC, 2019. URL: <https://www.ptc.com/en/products/augmented-reality/vuforia>.
- [37] Unity Real-Time Development Platform | 3D, 2D VR & AR Visualizations, 2000. URL: <https://unity.com/>.
- [38] Visual Studio 2019 | Visual Studio, 2018. URL: <https://visualstudio.microsoft.com>.

- [39] Virtual Reality (VR) App Development (UC San Diego, 2019), 2019. URL: <https://www.edx.org/professional-certificate/ucsandiegox-virtual-reality-app-development>.
- [40] J. Glover, Unity 2018 AR Projects: Build four immersive and fun AR applications using ARKit, ARCore, and Vuforia, Packt Publishing, Birmingham, 2018.

Improving the learning environment for future mathematics teachers with the use application of the dynamic mathematics system GeoGebra AR

Nataliia V. Osypova^{1,2}, Volodimir I. Tatochenko¹

¹*Kherson State University, 27 University Str., Kherson, 73003, Ukraine*

²*Kherson Academy of Continuing Education, 41 Pokrysheva Str., Kherson, 73034, Ukraine*

Abstract

Immersive technologies and, in particular, augmented reality (AR) are rapidly changing the sphere of education, especially in the field of science, technology, engineering, arts and mathematics. High-quality professional training of a future mathematics teacher who is able to meet the challenges that permeate all sides, the realities of the globalizing information society, presupposes reliance on a highly effective learning environment. The purpose of the research is to transform the traditional educational environment for training future mathematics teachers with the use of the GeoGebra AR dynamic mathematics system, the introduction of cloud technologies into the educational process. The educational potential of GeoGebra AR in the system of professional training of future mathematics teachers is analyzed in the paper. Effective and practical tools for teaching mathematics based on GeoGebra AR using interactive models and videos for mixed and distance learning of students are provided. The advantages of the GeoGebra AR dynamic mathematics system are highlighted. The use of new technologies for the creation of didactic innovative resources that improve the process of teaching and learning mathematics is presented on the example of an educational and methodological task, the purpose of which is to create didactic material on the topic "Sections of polyhedra". While solving it, future teachers of mathematics should develop the following constituent elements: video materials; test tasks for self-control; dynamic models of sections of polyhedra; video instructions for constructing sections of polyhedra and for solving basic problems in the GeoGebra AR system. The article highlights the main characteristics of the proposed educational environment for training future mathematics teachers using the GeoGebra AR dynamic mathematics system: interdisciplinarity, polyprofessionalism, dynamism, multicomponent.

Keywords

augmented reality, GeoGebra AR, learning environment, teacher training, professional competences

1. Introduction

The rapid changes that are taking place in the post-industrial society require from the pedagogical higher educational institutions of the world and Ukraine a better provision of the

AREdu 2021: 4th International Workshop on Augmented Reality in Education, May 11, 2021, Kryvyi Rih, Ukraine

✉ nataliesunny@gmail.com (N. V. Osypova); tatochenko@ksu.ks.ua (V. I. Tatochenko)

🌐 <http://www.kspu.edu/About/Faculty/FPhysMathemInformatics/ChairInformatics/Staff/Osipova.aspx>
(N. V. Osypova);

<http://www.kspu.edu/About/Faculty/FPhysMathemInformatics/ChairAlgGeomMathAnalysis/Staff.aspx>
(V. I. Tatochenko)

🆔 0000-0002-9929-5974 (N. V. Osypova); 0000-0002-8984-268X (V. I. Tatochenko)

© 2021 Copyright for this paper by its authors.
Use permitted under Creative Commons License Attribution 4.0 International (CC BY 4.0).



CEUR Workshop Proceedings (CEUR-WS.org)

educational process. Now, in the leading countries of the world, there is a sharp modernization of educational processes and a modern school, both higher and secondary, cannot stand aside.

The quality of mathematical training is an indicator of the readiness of the society for radical changes. New approaches to the organization of the educational process are substantiated in the main state documents of Ukraine that regulate the reform of the educational system:

- National doctrine of education development [1];
- Law of Ukraine on Education [2];
- State National Program “Education” (“Ukraine of the XXI century”) [3];
- The concept of development of natural and mathematical education (STEM education) [4].

Today, reforming the education system is a strategic problem for all developed countries. Ukraine’s integration into the international educational community, the need for urgent restructuring of existing industries in accordance with the requirements of the world market primarily requires improving the quality of education.

Mathematical knowledge, skills and abilities are considered not as an end in itself of education, but as a means of learning about the world, meeting cognitive and practical needs, as a universal language of science and technology that allows to model and explore the around world. Therefore, the national school, both higher and secondary levels, faces the task of forming a new paradigm of education, in which students develop a system of universal knowledge, skills, experience of independent creative activity, a set of key competencies that ensure dynamic adaptation of the individual to a new, rapidly changing information society and its full functioning in it.

In the emerging new educational space, a new system of values is emerging, where it is not knowledge, skills and abilities that dominate, but the ability to quickly navigate information flows, to respond to ever-changing challenges. The main qualities of the modern personality are the universality of all mental processes (thinking, memory, attention, motivational sphere), their dynamism and mobility. It is necessary to fundamentally rethink all the factors of the education crisis. Mathematical education, being the basis for successful participation in the modern information society, taking into account global trends and innovations is constantly updated. The quality of mathematical training is an important indicator of society’s readiness to solve practical problems of the modern labor market, receive quality professional education and further education in the future.

Personality-oriented, activity, competence, technological, adaptive, environmental approaches, informatization, integration are the methodological basis of a qualitatively new educational process as a complex, nonlinear, multilevel, integrated education. Psychological and pedagogical science has accumulated considerable experience in the formation and development of educational space. The variability of the education system presupposes theoretical research on its structure and identification of the real subjects of the educational space, as a necessary and sufficient condition for its existence and continuous renewal.

2. Related work

The problem of the educational environment was studied in the works of the classics of psychology and pedagogy: Comenius [5], Locke [6], Rousseau [7], Pestalozzi et al. [8].

In modern education, the essence of the concept of “educational environment” and its various aspects were studied by Aars and Christensen [9], Abed et al. [10], Alahmadi [11], Al-Marroof et al. [12], Andersson [13], Berrani et al. [14], Bondarenko et al. [15], Camacho et al. [16], Chrysafiadi et al. [17], Dotsenko [18], Fuentes-Moreno et al. [19], Horbatiuk et al. [20], Huh [21], Kerimbayev et al. [22], Kyslova et al. [23], Lechthaler et al. [24], Lawless and Riel [25], Lee et al. [26], Morze and Kucherovska [27], Mousavi et al. [28], Orlando et al. [29], Sahu et al. [30], Shapovalov et al. [31], Smogorzewska et al. [32], Stratulat et al. [33], Tleubay et al. [34], Uchitel et al. [35], Yang et al. [36] and others. The educational environment is considered as a factor of education from the standpoint of understanding education as a special sphere of social life.

A thorough analysis of models of the educational environment and its components was carried out by Bykov [37].

The concept of information and communication learning environment, current issues of organization of open and distance learning systems are covered in the research of Bobyliev and Vihrova [38], Bykov et al. [39], Gergei and Mashbits [40], Glushkov [41], Mintii et al. [42], Monakhov et al. [43], Monakhov [44], Polhun et al. [45], Shokaliuk et al. [46], Spivakovsky et al. [47], Syvyi et al. [48], Yershóv [49], Zhaldak and Franchuk [50], Zhaldak et al. [51] and others.

Book et al. [52], Cook [53], Freedy et al. [54], Hardin et al. [55], Ji-Ping and De Diana [56], Kaltenborn et al. [57], Linstead [58], Mendiburo and Biswas [59], Mevarech [60], Milne and Rowe [61], Morris [62], Pagano et al. [63], Pizzutilo and Tangorra [64], Porta [65], Rowe and Gregor [66], Sambrook et al. [67], Semerikov et al. [68], Shubin et al. [69], Sleeman and Hartley [70], Tait and Hughes [71], Wegner et al. [72] and others have studied the creation and implementation of computer-based learning systems.

Various aspects of using the GeoGebra dynamic mathematics system are studied by Abánades et al. [73], Bhagat and Chang [74], Botana et al. [75], Diković [76, 77], Drushlyak et al. [78], Flehantov and Ovsienko [79], Hohenwarter and Preiner [80], Jacinto and Carreira [81], Jelatu et al. [82], Kovács and Parisse [83], Kramarenko et al. [84], Reis [85], Reis and Ozdemir [86], Saha et al. [87], Takači et al. [88], Tatar and Zengin [89], Velichová [90], Verhoef et al. [91], Zengin et al. [92], Zulnaidi and Zakaria [93], Zulnaidi and Zamri [94].

Hrybiuk [95], Hrybiuk and Yunchik [96], Rakuta [97, 98, 99] consider the issues of organization of the learning environment with the use of the system of dynamic mathematics GeoGebra for professional training of future specialists.

The solution to the problem of informatization of the educational process using the BYOD (Bring Your Own Device) approach and subject-oriented cloud services using GeoGebra is considered in the work [100].

The relevance of the issues of organizing the learning environment is confirmed by a large number of publications devoted to this problem (702 issues results for Learning Environment in link.springer.com) [101, 102, 103].

Important aspects of the learning environments organization are discussed at numerous international conferences: Transforming the Teaching & Learning Environment 2021 [104],

Augmented Reality in Education (AREdu) 2018-2021 [105, 106, 107, 108], Learning Environments 2019 [109] and others.

International associations such as International Association of Smart Learning Environments [110], Association for Learning Environments [111] contribute to the creation of effective learning environments that reflect the unique capabilities of the community.

3. Problem setting

The purpose of the paper is to improve the traditional learning environment for training future mathematics teachers through the use of the GeoGebra AR dynamic mathematics system, the introduction of cloud technologies into the educational process for their use in mixed and distance learning of students.

Tasks:

- Investigate the concept of future mathematics teachers learning environment;
- Analyze the educational potential of the GeoGebra AR dynamic mathematics system in the system of professional training of future mathematics teachers;
- Analyze of main features and benefits of Dynamic Mathematics GeoGebra AR system for future Math teacher's training;
- Illustrate the technology of creating didactic innovative resources to improve the teaching and learning process of mathematics on the example of the educational and methodological task of creating didactic material on the topic "Sections of polyhedral";
- Transformation of the traditional learning environment for the preparation of future mathematics teachers, the introduction of cloud-based and immersive technologies into the educational process in order to form professional competencies of future mathematics teachers in the field of information and communication technologies.

4. The concept of learning environment for future mathematics teachers

Qualitative professional training of a future mathematics teacher, who is able to respond to today's challenges that permeate all sides, the realities of the globalizing information society, provides a reliance on a highly effective learning environment [112].

At the present stage of functioning of a pedagogical institution of higher education, the learning environment is designed to stimulate higher education students to acquire professional knowledge, skills and experience, awareness of the need for emotional and volitional regulation of educational and cognitive activities through a system of attitudes, reflection and successful professional self-realization.

We interpret the learning environment for future mathematics teachers as an open, complex, multilevel, dynamic, branched, multi-component, holistic, objectively existing, purposeful system, characterized by a certain set of material subjects, on the background of which educational professional programs, the content of educational components, the length of the educational process over time.

A necessary and sufficient conditions for such composition are the subjects of the educational space, material objects that change during their life, as well as the intangible components of life processes, subjects of the natural and socio-cultural environment as habitats, which makes it possible to enrich and update the content of education, turn their properties into personalized experience of future mathematics teachers, necessary for successful self-realization both in the learning environment itself and in the environment where the graduate will go. The learning environment is characterized by interdisciplinarity and polyprofessionalism, the dynamic movement of the future mathematics teacher from educational activity to professional activity, personal inclusion in all types of activities and their design as a step-by-step independent work [113, 114, 115].

The modern information society requires the creation of a sufficiently effective learning environment in the pedagogical institution of higher education to train future mathematics teachers, which is an artificially constructed system aimed at achieving a set of different goals and nature of higher education, providing not only certain knowledge, skills, abilities, but also mastering of professional competences, ability to act quickly in various professional situations [116].

The development of society, science, technology, technologies leads to appropriate changes in the methodological system of education. This in turn forces the learning environment to change constantly. Both individual components and the whole structure of the learning environment need to be changed.

As the structure of the learning environment becomes more complicated or updated, both the educational and cognitive activity of the future mathematics teacher and the system of actions through which it is carried out and which is mastered by the applicant of higher education become more complicated. Changing the elements and characteristics of the learning environment leads to change, expanding the area of immediate activity of the subjects of the educational process, ways of their behavior, the system of educational goals [117, 118].

5. Analysis of the possibilities of the dynamic mathematics system GeoGebra AR in the system of training future mathematics teachers

In practical classes on methods of teaching mathematics, considerable attention should be paid to the use of digital technologies to prepare future mathematics teachers to visualize the teaching material of school mathematics, which will greatly improve the quality and effectiveness of teaching, diversify teaching aids and forms. As digital media become more widespread and accessible, the focus of the educational process is shifting toward individual, blended, and distance learning [119, 120].

Prospective math teachers should be introduced to existing programs that they can use to visualize and teach math. Such programs include Maple, Derive, Mathematica, Geometry Expressions, Live Geometry, Mathcad, Blender, GRAN and more. Each of these programs has its drawbacks and its strengths [121].

Today, many educators and methodologists pay attention to the possibilities of the GeoGebra AR program as a system of dynamic mathematics, which is constantly improved and updated.

GeoGebra is powerful Math Applications which includes Suite Calculator; 3D Calculator; CAS Calculator; Geometry; Graphing Calculator; Scientific Calculator; GeoGebra Classic; Testing [122].

Graphing Calculator released GeoGebra is used for Windows, Android and iPhone tablets and phones. The environment provides the organization of the process of teaching natural sciences and mathematics the design of dynamic graphic objects and conducting research using augmented reality. The GeoGebra community's collection of teaching and learning materials consists of more than 300,000 free and dynamic worksheets and books. For convenient organization of the educational process and cooperation between students and teachers GeoGebra provides for the creation of classes and the use of groups.

Future math teachers should emphasize the benefits of this program: dynamism, constant updating, a wide range of functionality, intuitive interface, the ability to work in different modes, the ability to install on mobile devices, multilingual, free, the ability to interact at a professional level, the possibility of use at different levels of education, the possibility of organizing the management and correction of learning, the possibility of creating educational content directly in the learning environment, the possibility of sharing with the environment, which is a source of contextual enrichment and updating the content of education, cognitive activity, which leads to a reduction of the digital divide between the subjects of the learning environment, the ability to create high-quality dynamic computer models (creating a visual spatial image and tracking the state of the created model due to changing parameters of its elements), the ability to use program material and its adaptation to specific learning conditions.

The modern learning environment provides for the transition from informative to active methods and techniques of teaching. Emphasis shifts from the predominantly educational function of the teacher to enhancing the cognitive activity of the student. An important aspect is to ensure the connection between education and professional practice [123].

The learning environment of dynamic mathematics GeoGebra AR should be used in teaching the following mandatory and optional components of professional training of future mathematics teachers:

- Methods of teaching mathematics;
- Elementary mathematics;
- Analytical geometry;
- Linear algebra;
- Mathematical analysis;
- Projective geometry and image methods;
- Methods of teaching mathematics in the profile school;
- Methods of distance education;
- Methods of STEM-education;
- Use of learning environments in mathematics.

The learning environment of dynamic mathematics GeoGebra AR provides more effective than in traditional learning the formation of competencies:

- Integral competence: The ability to solve complex professional problems and practical problems in education, which involves the application of theories and methods of psychology, pedagogy and mathematics and is characterized by complexity and uncertainty of pedagogical conditions of the educational process in educational institutions of different levels.
- Special (professional, subject) competencies:
 - Ability to apply the results of research and / or innovation activities in a practical way, which correspond to the latest achievements.
 - Ability to apply interdisciplinary approaches in critical thinking of professional problems.
 - Ability to use the principles, methods and organizational forms of research and / or innovation to make optimal decisions and interpret their results.
 - Ability to develop an education system and determine the role of the mathematical component in it.
 - Ability to independently develop experimental and observational research and analyze the data obtained on their basis, through the creative application of existing and generating new professional ideas.
 - Ability to improve existing and develop new methods of analysis, modeling, forecasting, problem solving in new areas of education.
 - Ability to self-educate and improve skills on the basis of innovative approaches in the field of education.
 - Ability to master and apply the psychological and didactic foundations of teaching mathematics.
 - Ability to initiate and conduct research in a specialized field of education [124].

6. An example of educational and methodical task of creating didactic material on the topic “Sections of polyhedra” using the system GeoGebra AR

Here is an example of an educational and methodological task, the purpose of which is to create didactic material on the topic “Sections of polyhedra”. In solving it, future math teachers should develop the following components:

1. Video material “Learn more about polyhedra”.
2. Test tasks for self-control of information assimilation of video material.
3. Dynamic models of a cube, parallelepiped, prism, pyramid with the possibility of demonstration in the dynamics of changes in the states of these objects when changing the parameters of their elements [122, 125, 126, 100].
4. Video tutorial “How to build images of polyhedra of different types in GeoGebra?”.
5. Video tutorial “How to explore polyhedrons in Augmented Reality in GeoGebra?”.
6. Video material on solving the basic problem in parallel and central projection of such content.

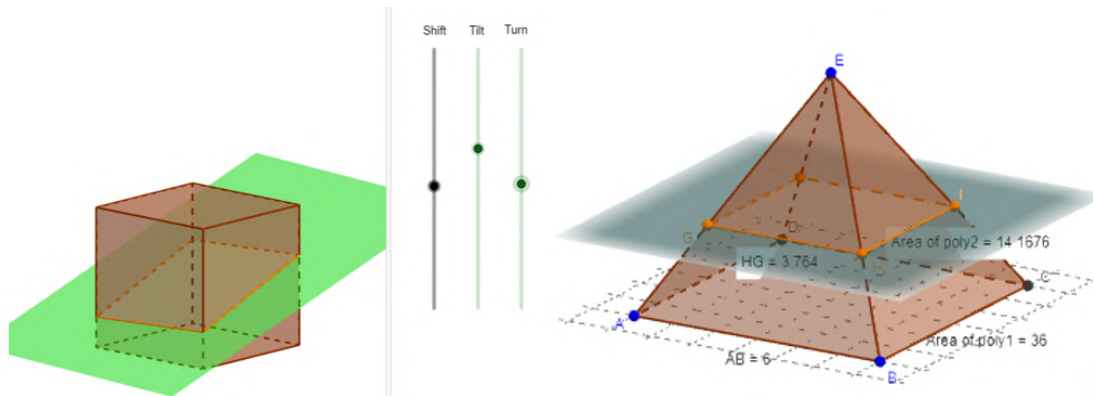

Figure 1: Dynamic models: Cross Sections of a Cube. Pyramid section.

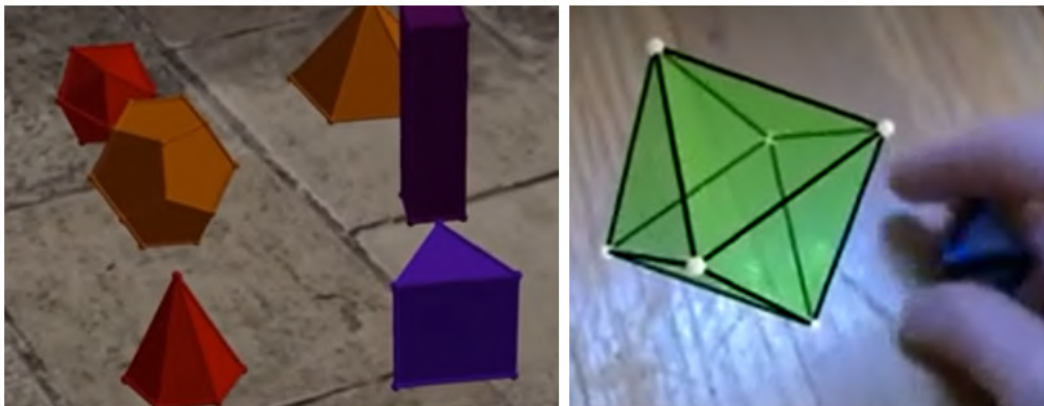

Figure 2: GeoGebra Augmented Reality (<https://www.youtube.com/watch?v=nmIIO9KZNww>).
Octahedron (<https://www.youtube.com/watch?v=kZvdDPWhLmY>).

Given:

α – plane,

$A(A1)$, $B(B1)$, $C(C1)$ – points and their projections,

$D1$ – projection of an unknown point D .

Find: D .

The solution of this basic problem by a method of traces and a method of conformity both at parallel, and at the central projection, leads to the corresponding algorithms.

1. Example of construction of a section of a cube with dynamic reproduction of algorithm of construction by a method of traces.
2. Example of construction of a section of a triangular pyramid with dynamic reproduction of the algorithm of construction by the method of traces.

3. Example of construction of a section of an arbitrary prism with dynamic reproduction of construction by the method of correspondence.
4. Example of construction of a section of an arbitrary pyramid with dynamic reproduction of the algorithm of construction by the method of correspondence.
5. The task that will help consolidate the acquired knowledge and skills: to build the specified section of a cube or triangular pyramid in GeoGebra and find its area.

Task 1. Determine the cross-sectional shape of the cube with a plane that is drawn through the middle of the edges AB , AA_1 and A_1D_1 find the cross-sectional area if the edge of the cube has length a .

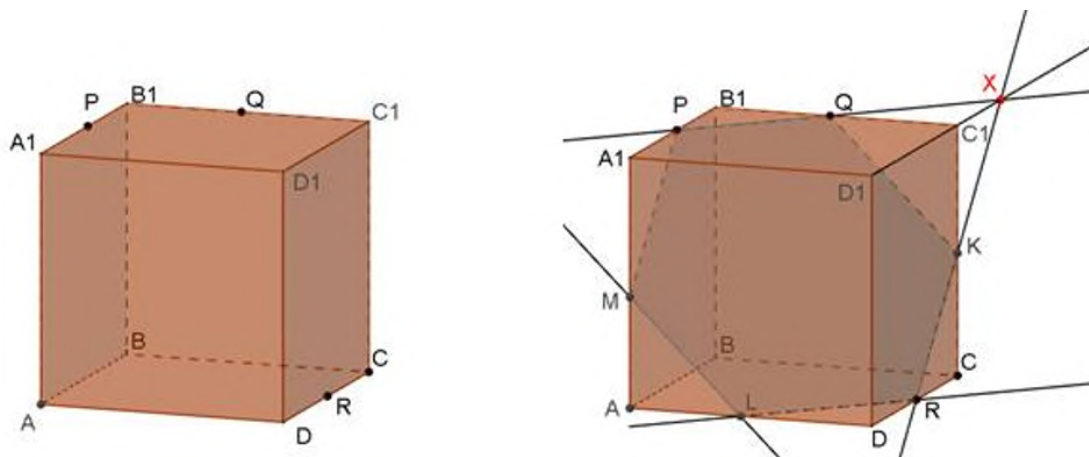

Figure 3: Cross-section of the cube.

Task 2. On the edges AA_1 and CC_1 the parallelepiped are the corresponding points M and N so that $AM : AA_1 = m$, $CN : CC_1 = n$. Construct a section with a plane passing through the points M and N parallel to the diagonal BD of the base. Determine in what ratio this plane divides the edge BB_1 .

The use of the GeoGebra AR package in the pedagogical specialties of the university is a joint activity of all subjects of the educational space, aimed at developing in future mathematics teachers the ability to search in the creation of educational and methodological tasks according to the plan offered by the teacher, the ability to carry out independent professional intelligence and interdisciplinary research with the assistance of teacher, the skill of conducting an independent search for a trans disciplinary plan based on active interaction and creating conditions for success.

In the process of using the GeoGebra AR package, the teacher coordinates the educational and cognitive activities of students, aimed at acquiring new knowledge and experience in relation to this software, encourages them to explore new professional knowledge and the formation of special competencies.

The introduction of the system of dynamic mathematics GeoGebra in the process of training future teachers of mathematics changes the place and role of higher education in the educa-

tional process, the way they acquire new knowledge and experience in methods of teaching mathematics.

Advantages of using GeoGebra: activation of the educational process, the formation of deep internal motivation, within which there is a shift from the focus on results to the focus on ways of learning and cognitive activity and their improvement. Moreover, the more valuable the use of software, the more significant tumors occur in the motivation to learn. In addition, there is space for self-realization, self-improvement of future mathematics teachers.

Introducing the use of GeoGebra AR, the teacher thus demonstrates to students innovative forms of teaching, teaches future mathematics teachers to use the acquired professional knowledge, skills and abilities in future activities [113].

In connection with the introduction to the training of future teachers of mathematics laboratory and practical work on methods of teaching mathematics, focused on the GeoGebra AR package, provides for the gradual involvement of students in mastering these tools, to explore objects in mathematics, pedagogy, psychology. Due to this, students are involved in the development and implementation of GeoGebra model, GeoGebra projects, their own GeoGebra researches, are involved in scientific and methodological studies of teachers.

Using GeoGebra AR reveals the personal professional potential of a future math teacher.

7. Conclusions and outlook

The analysis of scientific publications made it possible to determine the concept of an learning environment for the training of future mathematics teachers, its structure and models.

The use of the GeoGebra AR dynamic mathematics system, the introduction of cloud and immersive technologies into the educational process makes it possible to form the professional competencies of future mathematics teachers more effectively, in particular in the field of information and communication technologies.

The examples show that the use of the GeoGebra AR system allows making the teaching of mathematics practice-oriented, applying research methods, and increasing the motivation of students' learning. Opportunities to create and study interactive dynamic models in the learning environment GeoGebra AR increase the efficiency of the learning process of natural sciences and mathematics, promote the development of logical thinking and increase the level of motivation of students.

In the future, we are planning development and implement a special course "GeoGebra AR for future teachers of mathematics and physics".

References

- [1] National doctrine of education development, 2002. URL: <https://osvita.ua/legislation/other/2827/>.
- [2] Law of Ukraine On Education, 2017. URL: <https://zakon.rada.gov.ua/laws/show/2145-19#Text>.
- [3] State National Program Education "Ukraine of the XXI century", 1993. URL: <https://zakon.rada.gov.ua/laws/show/896-93-%D0%BF#Text>.

- [4] The concept of development of natural and mathematical education (STEM education), 2020. URL: <https://zakon.rada.gov.ua/laws/show/960-2020-%D1%80#Text>.
- [5] J. Comenius, La conception de l'éducation des jeunes enfants selon, *International Journal of Early Childhood* 25 (1993) 60–64. doi:10.1007/BF03185620.
- [6] J. Locke, *A Letter Concerning Toleration*, John Wiley and Sons, 2011. doi:10.1002/9781118011690.ch3.
- [7] J.-J. Rousseau, *The Social Contract*, John Wiley and Sons, 2011. doi:10.1002/9781118011690.ch7.
- [8] J. Pestalozzi, J. Piaget, F. Froebel, *Conversation 4: How do young children learn?*, SAGE Publications Inc., 2014. doi:10.4135/9781446288863.
- [9] J. Aars, D. Christensen, Education and political participation: the impact of educational environments, *Acta Politica* 55 (2020) 86–102. doi:10.1057/s41269-018-0101-5.
- [10] S. Abed, N. Alyahya, A. Altameem, IoT in education: Its impacts and its future in saudi universities and educational environments, *Advances in Intelligent Systems and Computing* 1045 (2020) 47–62. doi:10.1007/978-981-15-0029-9_5.
- [11] A. Alahmadi, Design an optimum climate control system for efficient smart universities educational environment, *International Journal of Scientific and Technology Research* 9 (2020) 440–449.
- [12] R. Al-Marroof, A. Alfaisal, S. Salloum, Google glass adoption in the educational environment: A case study in the Gulf area, *Education and Information Technologies* 26 (2021) 2477–2500. doi:10.1007/s10639-020-10367-1.
- [13] E. Andersson, Political socialization and the coach-created educational environment of competitive games: the case of grassroots youth soccer in Sweden, *Soccer and Society* 21 (2020) 725–740. doi:10.1080/14660970.2019.1711063.
- [14] H. Berrani, R. Abouqal, A. Izgua, Moroccan residents' perceptions of the hospital learning environment measured with the french version of the postgraduate hospital educational environment measure, *Journal of Educational Evaluation for Health Professions* 17 (2020). doi:10.3352/JEEHP.2020.17.4.
- [15] O. Bondarenko, O. Pakhomova, W. Lewoniewski, The didactic potential of virtual information educational environment as a tool of geography students training, *CEUR Workshop Proceedings* 2547 (2020) 13–23.
- [16] H. Camacho, M. Coto, S. Jensen, Participatory methods to support knowledge management systems design in educational environments, *International Journal of Knowledge Management Studies* 12 (2021) 34–54. doi:10.1504/IJKMS.2021.112210.
- [17] K. Chrysafiadi, M. Virvou, E. Sakkopoulos, Optimizing programming language learning through student modeling in an adaptive web-based educational environment, *Intelligent Systems Reference Library* 158 (2020) 205–223. doi:10.1007/978-3-030-13743-4_11.
- [18] N. A. Dotsenko, Technology of application of competence-based educational simulators in the informational and educational environment for learning general technical disciplines, *Journal of Physics: Conference Series* 1946 (2021) 012014. URL: <https://doi.org/10.1088/1742-6596/1946/1/012014>. doi:10.1088/1742-6596/1946/1/012014.
- [19] C. Fuentes-Moreno, M. Sabariego-Puig, A. Ambros-Pallarés, Developing social and civic competence in secondary education through the implementation and evaluation of teaching units and educational environments, *Humanities and Social Sciences Communications*

- 7 (2020). doi:10.1057/s41599-020-0530-4.
- [20] R. M. Horbatiuk, N. M. Bilan, O. A. Sitkar, O. S. Tymoshchuk, The formation of educational environment in foreign language training of energy engineering students by means of project technology, *Journal of Physics: Conference Series* 1840 (2021) 012047. URL: <https://doi.org/10.1088/1742-6596/1840/1/012047>. doi:10.1088/1742-6596/1840/1/012047.
- [21] S. Huh, Reflections as 2020 comes to an end: The editing and educational environment during the COVID-19 pandemic, the power of Scopus and Web of Science in scholarly publishing, journal statistics, and appreciation to reviewers and volunteers, *Journal of Educational Evaluation for Health Professions* 17 (2020). doi:10.3352/JEEHP.2020.17.44.
- [22] N. Kerimbayev, N. Nurym, A. Akramova, S. Abdykarimova, Virtual educational environment: interactive communication using LMS Moodle, *Education and Information Technologies* 25 (2020) 1965–1982. doi:10.1007/s10639-019-10067-5.
- [23] M. A. Kyslova, S. O. Semerikov, K. I. Slovak, Development of mobile learning environment as a problem of the theory and methods of use of information and communication technologies in education, *Information Technologies and Learning Tools* 42 (2014) 1–19. URL: <https://journal.iitta.gov.ua/index.php/itlt/article/view/1104>. doi:10.33407/itlt.v42i4.1104.
- [24] F. Lechthaler, M. Arigoni, M. Khamidova, D. Davlyatova, H. Prytherch, K. Wyss, Assessing the effects of the nursing education reform on the educational environment in tajikistan: A repeated cross-sectional analysis, *BMC Nursing* 19 (2020). doi:10.1186/s12912-020-0405-4.
- [25] K. Lawless, J. Riel, *Exploring the utilization of the big data revolution as a methodology for exploring learning strategy in educational environments*, Taylor and Francis, 2020.
- [26] V. Lee, P. Hodgson, C.-S. Chan, A. Fong, S. Cheung, Optimising the learning process with immersive virtual reality and non-immersive virtual reality in an educational environment, *International Journal of Mobile Learning and Organisation* 14 (2020) 21–35. doi:10.1504/IJMLO.2020.103908.
- [27] N. V. Morze, V. O. Kucherovska, Ways to design a digital educational environment for K-12 education, *CEUR Workshop Proceedings* 2879 (2020) 200–211.
- [28] A. Mousavi, A. Mohammadi, R. Mojtahedzadeh, M. Shirazi, H. Rashidi, E-learning educational atmosphere measure (EEAM): A new instrument for assessing e-students' perception of educational environment, *Research in Learning Technology* 28 (2020). doi:10.25304/rlt.v28.2308.
- [29] S. Orlando, E. Gaudio, F. De La Paz, Supporting teachers to monitor student's learning progress in an educational environment with robotics activities, *IEEE Access* 8 (2020) 48620–48631. doi:10.1109/ACCESS.2020.2978979.
- [30] P. Sahu, A. Phillips Savage, B. Sa, Exploring students' perceptions of the educational environment in a caribbean veterinary school:a cross-sectional study, *Journal of Veterinary Medical Education* 47 (2020) 668–677. doi:10.3138/JVME.2018-0008.
- [31] V. Shapovalov, Y. Shapovalov, Z. Bilyk, A. Atamas, R. Tarasenko, V. Tron, Centralized information web-oriented educational environment of Ukraine, *CEUR Workshop Proceedings* 2433 (2019) 246–255.
- [32] J. Smogorzewska, G. Szumski, P. Grygiel, Theory of mind goes to school: Does educational

- environment influence the development of theory of mind in middle childhood?, *PLoS ONE* 15 (2020). doi:10.1371/journal.pone.0237524.
- [33] S. Stratulat, O. Candel, A. Tăbîrță, L. Checheriță, V. Costan, The perception of the educational environment in multinational students from a dental medicine faculty in Romania, *European Journal of Dental Education* 24 (2020) 193–198. doi:10.1111/eje.12484.
- [34] S. Tleubay, G. Nurzhanova, S. Ybyshova, S. Abdigulova, A. Mankesh, T. Kerimbekov, A. Ualikhanuly, The formation of intercultural communicative competence of future teachers in a trilingual educational environment, *International Journal of Emerging Technologies in Learning* 15 (2020) 148–164. doi:10.3991/ijet.v15i17.14249.
- [35] A. D. Uchitel, I. V. Batsurovska, N. A. Dotsenko, O. A. Gorbenko, N. I. Kim, Implementation of future agricultural engineers' training technology in the informational and educational environment, *CEUR Workshop Proceedings* 2879 (2020) 233–246.
- [36] S. Yang, J. Carter, R.A., L. Zhang, T. Hunt, Emanant themes of blended learning in K-12 educational environments: Lessons from the Every Student Succeeds Act, *Computers and Education* 163 (2021). doi:10.1016/j.compedu.2020.104116.
- [37] V. Bykov, Models of the education system and the educational environment, *Actual problems of the process of modernization of social systems* 27 (2010) 31–38. URL: https://www.kpi.kharkov.ua/archive/%D0%9D%D0%B0%D1%83%D0%BA%D0%BE%D0%B2%D0%B0_%D0%BF%D0%B5%D1%80%D1%96%D0%BE%D0%B4%D0%B8%D0%BA%D0%B0/elits/2010/27/%D0%9C%D0%BE%D0%B4%D0%B5%D0%BB%D1%96%20%D1%81%D0%B8%D1%81%D1%82%D0%B5%D0%BC%D0%B8%20%D0%BE%D1%81%D0%B2%D1%96%D1%82%D0%B8%20%D1%96%20%D0%BE%D1%81%D0%B2%D1%96%D1%82%D0%BD%D1%8C%D0%BE%D0%B3%D0%BE%20%D1%81%D0%B5%D1%80%D0%B5%D0%B4%D0%BE%D0%B2%D0%B8%D1%89%D0%B0.pdf.
- [38] D. Y. Bobyliev, E. V. Vihrova, Problems and prospects of distance learning in teaching fundamental subjects to future mathematics teachers, *Journal of Physics: Conference Series* 1840 (2021) 012002. URL: <https://doi.org/10.1088/1742-6596/1840/1/012002>. doi:10.1088/1742-6596/1840/1/012002.
- [39] V. Bykov, A. Dovgiallo, P. Kommers, Theoretical backgrounds of educational and training technology, *International Journal of Continuing Engineering Education and Life-Long Learning* 11 (2001) 412–441.
- [40] T. Gersei, E. Mashbits, Psychological and pedagogical problems of effective computer use in the educational process, *Russian Education & Society* 28 (1986) 213–229. doi:10.2753/RES1060-9393281011213.
- [41] V. Glushkov, Man and the automation of control, *Soviet Education* 18 (1976) 10–16. doi:10.2753/RES1060-9393180810.
- [42] I. S. Mintii, T. A. Vakaliuk, S. M. Ivanova, O. A. Chernysh, S. M. Hryshchenko, S. O. Semerikov, Current state and prospects of distance learning development in Ukraine, *CEUR Workshop Proceedings* (2021).
- [43] V. Monakhov, M. Lapchik, S. Beshenkov, The phases of computer-assisted problem solving, *Russian Education & Society* 28 (1986) 124–128. doi:10.2753/RES1060-9393281011214.
- [44] V. Monakhov, Didactic axiomatics cognition theory of pedagogical technology, *CEUR Workshop Proceedings* 1761 (2016) 32–39.

- [45] K. Polhun, T. Kramarenko, M. Maloivan, A. Tomilina, Shift from blended learning to distance one during the lockdown period using Moodle: test control of students' academic achievement and analysis of its results, *Journal of Physics: Conference Series* 1840 (2021) 012053. URL: <https://doi.org/10.1088/1742-6596/1840/1/012053>. doi:10.1088/1742-6596/1840/1/012053.
- [46] S. Shokaliuk, Y. Bohunencko, I. Lovianova, M. Shyshkina, Technologies of distance learning for programming basics on the principles of integrated development of key competences, *CEUR Workshop Proceedings* 2643 (2020) 548–562.
- [47] A. Spivakovsky, L. Petukhova, E. Spivakovska, V. Kotkova, H. Kravtsov, Three-subjective didactic model, *Communications in Computer and Information Science* 412 CCIS (2013) 252–273. doi:10.1007/978-3-319-03998-5_13.
- [48] M. Syvyi, O. Mazbayev, O. Varakuta, N. Panteleeva, O. Bondarenko, Distance learning as innovation technology of school geographical education, *CEUR Workshop Proceedings* 2731 (2020) 369–382.
- [49] A. Yershov, One view of man-machine interaction, *Journal of the ACM (JACM)* 12 (1965) 315–325. doi:10.1145/321281.321283.
- [50] M. I. Zhaldak, N. P. Franchuk, Some applications of the GRAN1 to analyze two-dimensional continuous probability distributions, *Journal of Physics: Conference Series* 1946 (2021) 012002. URL: <https://doi.org/10.1088/1742-6596/1946/1/012002>. doi:10.1088/1742-6596/1946/1/012002.
- [51] M. I. Zhaldak, V. M. Franchuk, N. P. Franchuk, Some applications of cloud technologies in mathematical calculations, *Journal of Physics: Conference Series* 1840 (2021) 012001. URL: <https://doi.org/10.1088/1742-6596/1840/1/012001>. doi:10.1088/1742-6596/1840/1/012001.
- [52] N. Book, D. Ludlow, O. Sitton, Development and implementation of a computer-based learning system in chemical engineering, 2001, pp. 3615–3628.
- [53] J. Cook, Dialogue in learning: Implications for the design of computer-based educational systems, *Institute of Electrical and Electronics Engineers Inc.*, 2002, pp. 987–991. doi:10.1109/CIE.2002.1186131.
- [54] A. Freedy, F. Hull, L. Lucaccini, J. Lyman, A computer-based learning system for remote manipulator control, *IEEE Transactions on Systems, Man and Cybernetics* 1 (1971) 356–363. doi:10.1109/TSMC.1971.4308319.
- [55] A. Hardin, C. Looney, M. Fuller, Computer based learning systems and the development of computer self-efficacy: Are all sources of efficacy created equal?, volume 4, 2006, pp. 2187–2197.
- [56] Z. Ji-Ping, I. De Diana, Collaborative computer-based learning in China: A system for classroom-based learning and teaching, *Lecture Notes in Computer Science (including subseries Lecture Notes in Artificial Intelligence and Lecture Notes in Bioinformatics)* 438 LNCS (1990) 442–452. doi:10.1007/BFb0020898.
- [57] R. Kaltenborn, M. Hadjiski, S. Koynov, Intelligent control of negative emotions in a computer-based learning system, *Institute of Electrical and Electronics Engineers Inc.*, 2020, pp. 119–124. doi:10.1109/IS48319.2020.9200190.
- [58] S. Linstead, Beyond competence: Management development using computer-based systems in experiential learning, *Management Learning* 21 (1990) 61–74. doi:10.1177/

135050769002100108.

- [59] M. Mendiburo, G. Biswas, Virtual manipulatives in a computer-based learning environment: How experimental data informs the design of future systems, *Lecture Notes in Computer Science (including subseries Lecture Notes in Artificial Intelligence and Lecture Notes in Bioinformatics)* 6738 LNAI (2011) 510–512. doi:10.1007/978-3-642-21869-9_85.
- [60] Z. Mevarech, The effectiveness of individualized versus cooperative computer-based integrated learning systems, *International Journal of Educational Research* 21 (1994) 39–52. doi:10.1016/0883-0355(94)90022-1.
- [61] I. Milne, G. Rowe, Interpreting computer code in a computer-based learning system for novice programmers, *Software - Practice and Experience* 35 (2005) 1477–1493. doi:10.1002/spe.680.
- [62] E. Morris, The design and evaluation of link: A computer-based learning system for correlation, *British Journal of Educational Technology* 32 (2001) 39–52. doi:10.1111/1467-8535.00175.
- [63] K. Pagano, A. Haddad, T. Crosby, Virtual reality-making good on the promise of immersive learning: The effectiveness of in-person training, with the logistical and cost-effective benefits of computer-based systems, *IEEE Consumer Electronics Magazine* 6 (2017) 45–47. doi:10.1109/MCE.2016.2614413.
- [64] S. Pizzutilo, F. Tangorra, Archo: A computer based learning system for teaching computer architecture, 2003, pp. 395–399.
- [65] M. Porta, E-learning and machine perception: in pursuit of human-like interaction in computer-based teaching systems, *International Journal of Knowledge and Learning* 3 (2007) 281–298. doi:10.1504/ijkl.2007.015556.
- [66] G. Rowe, P. Gregor, A computer based learning system for teaching computing: Implementation and evaluation, *Computers and Education* 33 (1999) 65–76. doi:10.1016/S0360-1315(99)00019-6.
- [67] S. Sambrook, S. Geertshuis, D. Cheseldine, Developing a quality assurance system for computer-based learning materials: Problems and issues, *Assessment and Evaluation in Higher Education* 26 (2001) 417–426. doi:10.1080/02602930120081998.
- [68] S. O. Semerikov, I. O. Teplytskyi, V. N. Soloviev, V. A. Hamaniuk, N. S. Ponomareva, O. H. Kolgatin, L. S. Kolgatina, T. V. Byelyavtseva, S. M. Amelina, R. O. Tarasenko, Methodic quest: Reinventing the system, *Journal of Physics: Conference Series* 1840 (2021) 012036. URL: <https://doi.org/10.1088/1742-6596/1840/1/012036>. doi:10.1088/1742-6596/1840/1/012036.
- [69] I. Shubin, O. Karmanenko, T. Gorbach, K. Umyarov, The methods of adaptation in computer-based training systems, *Institute of Electrical and Electronics Engineers Inc.*, 2015, pp. 64–67. doi:10.1109/ITIB.2015.7355054.
- [70] D. Sleeman, J. Hartley, Instructional models in a computer-based learning system, *International Journal of Man-Machine Studies* 1 (1969) 177–188. doi:10.1016/S0020-7373(69)80020-9.
- [71] K. Tait, I. Hughes, Some experiences in using a computer-based learning system as an aid to self-teaching and self-assessment, *Computers and Education* 8 (1984) 271–278. doi:10.1016/0360-1315(84)90030-7.

- [72] S. Wegner, K. Holloway, S. Wegner, The effects of a computer-based instructional management system on student communications in a distance learning environment, *Educational Technology and Society* 2 (1999) 219–231.
- [73] M. Abánades, F. Botana, Z. Kovács, T. Recio, C. Sólyom-Gecse, Development of automatic reasoning tools in GeoGebra, *ACM Communications in Computer Algebra* 50 (2016) 85–88. doi:10.1145/3015306.3015309.
- [74] K. Bhagat, C.-Y. Chang, Incorporating GeoGebra into geometry learning-a lesson from india, *Eurasia Journal of Mathematics, Science and Technology Education* 11 (2015) 77–86. doi:10.12973/eurasia.2015.1307a.
- [75] F. Botana, M. Hohenwarter, P. Janičić, Z. Kovács, I. Petrović, T. Recio, S. Weitzhofer, Automated theorem proving in GeoGebra: Current achievements, *Journal of Automated Reasoning* 55 (2015) 39–59. doi:10.1007/s10817-015-9326-4.
- [76] L. Diković, Applications GeoGebra into teaching some topics of mathematics at the college level, *Computer Science and Information Systems* 6 (2009) 191–203. doi:10.2298/CSIS0902191D.
- [77] L. Diković, Implementing dynamic mathematics resources with GeoGebra at the college level, *International Journal of Emerging Technologies in Learning* 4 (2009) 51–54. doi:10.3991/ijet.v4i3.784.
- [78] M. G. Drushlyak, O. V. Semenikhina, V. V. Proshkin, S. Y. Kharchenko, T. D. Lukashova, Methodology of formation of modeling skills based on a constructive approach (on the example of GeoGebra), *CEUR Workshop Proceedings* 2879 (2020) 458–472.
- [79] L. Flehantov, Y. Ovsienko, The simultaneous use of Excel and GeoGebra to training the basics of mathematical modeling, *CEUR Workshop Proceedings* 2393 (2019) 864–879.
- [80] M. Hohenwarter, J. Preiner, Dynamic mathematics with GeoGebra, *Journal of Online Mathematics and its Applications* (2007).
- [81] H. Jacinto, S. Carreira, Mathematical problem solving with technology: the techno-mathematical fluency of a student-with-GeoGebra, *International Journal of Science and Mathematics Education* 15 (2017) 1115–1136. doi:10.1007/s10763-016-9728-8.
- [82] S. Jelatu, Sariyasa, I. Made Ardana, Effect of GeoGebra-aided react strategy on understanding of geometry concepts, *International Journal of Instruction* 11 (2018) 325–336. doi:10.12973/iji.2018.11421a.
- [83] Z. Kovács, B. Parisse, Giac and GeoGebra – Improved Gröbner basis computations, *Lecture Notes in Computer Science (including subseries Lecture Notes in Artificial Intelligence and Lecture Notes in Bioinformatics)* 8942 (2015) 126–138. doi:10.1007/978-3-319-15081-9_7.
- [84] T. Kramarenko, O. Pylypenko, I. Muzyka, Application of GeoGebra in Stereometry teaching, *CEUR Workshop Proceedings* 2643 (2020) 705–718.
- [85] Z. Reis, Computer supported mathematics with GeoGebra, *Procedia - Social and Behavioral Sciences* 9 (2010) 1449–1455. doi:10.1016/j.sbspro.2010.12.348.
- [86] Z. Reis, S. Ozdemir, Using GeoGebra as an information technology tool: Parabola teaching, *Procedia - Social and Behavioral Sciences* 9 (2010) 565–572. doi:10.1016/j.sbspro.2010.12.198.
- [87] R. Saha, A. Ayub, R. Tarmizi, The effects of GeoGebra on mathematics achievement: Enlightening coordinate geometry learning, *Procedia - Social and Behavioral Sciences* 8

- (2010) 686–693. doi:10.1016/j.sbspro.2010.12.095.
- [88] D. Takači, G. Stankov, I. Milanovic, Efficiency of learning environment using GeoGebra when calculus contents are learned in collaborative groups, *Computers and Education* 82 (2015) 421–431. doi:10.1016/j.compedu.2014.12.002.
- [89] E. Tatar, Y. Zengin, Conceptual understanding of definite integral with GeoGebra, *Computers in the Schools* 33 (2016) 120–132. doi:10.1080/07380569.2016.1177480.
- [90] D. Velichová, Interactive maths with GeoGebra, *International Journal of Emerging Technologies in Learning* 6 (2011) 31–35. doi:10.3991/ijet.v6iS1.1620.
- [91] N. Verhoef, F. Coenders, J. Pieters, D. van Smaalen, D. Tall, Professional development through lesson study: teaching the derivative using GeoGebra, *Professional Development in Education* 41 (2015) 109–126. doi:10.1080/19415257.2014.886285.
- [92] Y. Zengin, H. Furkan, T. Kutluca, The effect of dynamic mathematics software GeoGebra on student achievement in teaching of trigonometry, *Procedia - Social and Behavioral Sciences* 31 (2012) 183–187. doi:10.1016/j.sbspro.2011.12.038.
- [93] H. Zulnaidi, E. Zakaria, The effect of using GeoGebra on conceptual and procedural knowledge of high school mathematics students, *Asian Social Science* 8 (2012) 102–106. doi:10.5539/ass.v8n11p102.
- [94] H. Zulnaidi, S. Zamri, The effectiveness of the GeoGebra software: The intermediary role of procedural knowledge on students’ conceptual knowledge and their achievement in mathematics, *Eurasia Journal of Mathematics, Science and Technology Education* 13 (2017) 2155–2180. doi:10.12973/eurasia.2017.01219a.
- [95] O. Hrybiuk, Virtual education middle as an innovative resource for new and pre-old students’ activity, in: *International scientific-practical Internet conference “Virtual education space: psychological problems”*, 2013. URL: https://www.psytir.org.ua/Tezy/2013_05/Grybyuk_Olena_2013_05.doc.
- [96] O. Hrybiuk, V. Yunchik, Solving heuristic problems in the context of STEM education using the system of dynamic mathematics GeoGebra, *Modern informational technologies and innovative methods in professional training: methodology, theory, experience, problems* 43 (2015) 206–218. URL: <https://vspu.net/sit/index.php/sit/issue/view/100>.
- [97] V. M. Rakuta, GeoGebra dynamic mathematics system, as innovative tool for the study of mathematics, *Information Technologies and Learning Tools* 30 (2012). URL: <https://journal.iitta.gov.ua/index.php/itlt/article/view/700>. doi:10.33407/itlt.v30i4.700.
- [98] V. Rakuta, GeoGebra 5.0 for mathematics teachers. *Algebra (new version)*, Chernihiv, 2018. URL: <http://matematikaikt.blogspot.com/2018/05/blog-post.html>.
- [99] V. Rakuta, GeoGebra 5.0 for mathematics teachers. *Planimetry*, Chernihiv, 2018. URL: <https://matematikaikt.blogspot.com/2018/04/geogebra-50.html#links>.
- [100] O. V. Semenikhina, M. G. Drushliak, Y. V. Khvorostina, Use of GeoGebra cloud service in future math teachers’ teaching, *Information Technologies and Learning Tools* 73 (2019) 48–66. URL: <https://journal.iitta.gov.ua/index.php/itlt/article/view/2500>. doi:10.33407/itlt.v73i5.2500.
- [101] *Information Technologies and Learning Tools*, 2021. URL: <https://journal.iitta.gov.ua/index.php/itlt>.
- [102] N. M. Seel (Ed.), *Interactive Learning Environment*, Springer US, Boston, MA, 2012, pp. 1604–1604. doi:10.1007/978-1-4419-1428-6_4448.

- [103] N. M. Seel (Ed.), *Highly Immersive e-Learning Environments*, Springer US, Boston, MA, 2012, pp. 1430–1430. URL: https://doi.org/10.1007/978-1-4419-1428-6_4237. doi:10.1007/978-1-4419-1428-6_4237.
- [104] 2021 transforming the teaching & learning environment virtual conference, 2021. URL: <https://teaching.pitt.edu/featured/2021-transforming-the-teaching-learning-environment-virtual-conference/>.
- [105] S. Semerikov, M. Shyshkina, Preface, *CEUR Workshop Proceedings 2168* (2017).
- [106] A. Kiv, M. Shyshkina, S. Semerikov, A. Striuk, Y. Yechkalo, *AREdu 2019 – How augmented reality transforms to augmented learning*, *CEUR Workshop Proceedings 2547* (2020) 1–12. URL: <http://ceur-ws.org/Vol-2547/paper00.pdf>.
- [107] O. Burov, A. Kiv, S. Semerikov, A. Striuk, M. Striuk, L. Kolgatina, I. Oliinyk, *AREdu 2020 - How augmented reality helps during the coronavirus pandemic*, *CEUR Workshop Proceedings 2731* (2020) 1–46.
- [108] S. H. Lytvynova, S. O. Semerikov, A. M. Striuk, M. I. Striuk, L. S. Kolgatina, V. Y. Velychko, I. S. Mintii, O. O. Kalinichenko, S. M. Tukalo, *AREdu 2021 – Immersive technology today*, *CEUR Workshop Proceedings* (2021).
- [109] *Learning environments 2019*, 2019. URL: <https://workplacetrends.co/events/learningenvironments2019/>.
- [110] *International Association of Smart Learning Environments – Optimizing learning environments to enhance learning*, 2021. URL: <http://iasle.net/>.
- [111] *Association for Learning Environments | UK Learning*, 2021. URL: <https://a4le.co.uk/>.
- [112] N. Osipova, H. Kravtsov, O. Hniedkova, T. Lishchuk, K. Davidenko, *Technologies of virtual and augmented reality for high education and secondary school*, *CEUR Workshop Proceedings 2393* (2019) 121–131. URL: http://ceur-ws.org/Vol-2393/paper_258.pdf.
- [113] N. Osypova, O. Kokhanovska, G. Yuzbasheva, H. Kravtsov, *Augmented and virtual reality technologies in teacher retraining*, *CEUR Workshop Proceedings 2732* (2020) 1203–1216. URL: <http://ceur-ws.org/Vol-2732/20201203.pdf>.
- [114] N. Kushnir, N. Osipova, N. Valko, O. Litvinenko, *The experience of the master classes as a means of formation of readiness of teachers to implement innovation*, in: A. Ginige, H. C. Mayr, D. Plexousakis, V. Ermolayev, M. Nikitchenko, G. Zholtkevych, A. Spivakovskiy (Eds.), *Information and Communication Technologies in Education, Research, and Industrial Applications*, Springer International Publishing, Cham, 2017, pp. 184–199.
- [115] E. Spivakovska, N. Osipova, M. Vinnik, Y. Tarasich, *Information competence of university students in Ukraine: Development status and prospects*, in: V. Ermolayev, H. C. Mayr, M. Nikitchenko, A. Spivakovsky, G. Zholtkevych (Eds.), *Information and Communication Technologies in Education, Research, and Industrial Applications*, Springer International Publishing, Cham, 2014, pp. 194–216.
- [116] D. J. C. Herr, B. Akbar, J. Brummet, S. Flores, A. Gordon, B. Gray, J. Murday, *Convergence education—an international perspective*, *Journal of Nanoparticle Research* 21 (2019) 229. doi:10.1007/s11051-019-4638-7.
- [117] A. Striuk, *Design of educational objects augmented reality*, *Transactions. Georgian Technical University. Automated control systems* 2 (2018) 127–134. URL: https://lib.iitta.gov.ua/713670/1/striuk_a_m.pdf.
- [118] M. Shabanova, L. Shestakova, N. Getmanskaya, O. Bezumova, S. Malysheva, *New Ge-*

- oGebra features for converged student projects, in: Anniversary International Scientific Conference “Synergetics and Reflection in Mathematics Education”, 16-18 October 2020, Pamporovo, Bulgaria, 2020, pp. 175–186. URL: http://srem2020.fmi-plovdiv.org/wp-content/uploads/2020/10/5_17_Shabanova.pdf.
- [119] B. Ancochea, M.-I. Cárdenas, Exploring real world environments using potential of Geogebra AR, in: M. Ludwig, S. Jablonski, A. Caldeira, A. Moura (Eds.), Research on Outdoor STEM Education in the digiTal Age. Proceedings of the ROSETA Online Conference in June 2020, WTM, Münster, 2020, pp. 41–46. URL: <https://www.wtm-verlag.de/DOI-Deposit/978-3-95987-144-0/978-3-95987-144-0-Book.pdf>. doi:<https://doi.org/10.37626/GA9783959871440.0.05>.
- [120] K. V. Vlasenko, I. V. Lovianova, O. G. Rovenska, T. S. Armash, V. V. Achkan, Development of the online course for training master students majoring in mathematics, *Journal of Physics: Conference Series* 1946 (2021) 012001. URL: <https://doi.org/10.1088/1742-6596/1946/1/012001>. doi:10.1088/1742-6596/1946/1/012001.
- [121] R. Fernández-Enríquez, L. Delgado-Martín, Augmented reality as a didactic resource for teaching mathematics, *Applied Sciences* 10 (2020). URL: <https://www.mdpi.com/2076-3417/10/7/2560>. doi:10.3390/app10072560.
- [122] GeoGebra - the world’s favorite, free math tools used by over 100 million students and teachers, 2021. URL: <https://www.geogebra.org/>.
- [123] J. Jesionkowska, F. Wild, Y. Deval, Active learning augmented reality for steam education—a case study, *Education Sciences* 10 (2020). URL: <https://www.mdpi.com/2227-7102/10/8/198>. doi:10.3390/educsci10080198.
- [124] Professional programs, 2020. URL: <http://www.kspu.edu/About/Faculty/FPhysMathemInformatics/ChairAlgGeomMathAnalysis/Professionalprograms.aspx>.
- [125] V. Rakuta, GeoGebra dlia pochatkivtiv. Vidkrytyi onlain-kurs dlia vchyteliv (vykladachiv) matematyky, 2019. URL: <https://padlet.com/valerarakuta/9rp9oa95ydml>.
- [126] Institute geogebra chernihiv, ukraine, 2018. URL: <https://sites.google.com/site/GeoGebrachernigiv/home>.

The development and use of mobile app AR Physics in physics teaching at the university

Arnold E. Kiv¹, Vladyslav V. Bilous², Dmytro M. Bodnenko²,
Dmytro V. Horbatovskiy², Oksana S. Lytvyn² and Volodymyr V. Proshkin²

¹Ben-Gurion University of the Negev, P.O.B. 653, Beer Sheva, 8410501, Israel

²Borys Grinchenko Kyiv University, 18/2 Bulvarno-Kudriavska Str., Kyiv, 04053, Ukraine

Abstract

This paper outlines the importance of using Augmented Reality (AR) in physics education at the university as a valuable tool for visualization and increasing the attention and motivation of students to study, solving educational problems related to future professional activities, improving the interaction of teachers and students. Provided an analysis of the types of AR technology and software for developing AR apps. The sequences of actions for developing the mobile application AR Physics in the study of topics: "Direct electronic current", "Fundamentals of the theory of electronic circuits". The software tools for mobile application development (Android Studio, SDK, NDK, Google Sceneform, 3Ds MAX, Core Animation, Asset Media Recorder, Ashampoo Music Studio, Google Translate Plugin) are described. The bank of 3D models of elements of electrical circuits (sources of current, consumers, measuring devices, conductors) is created. Because of the students' and teachers' surveys, the advantages and disadvantages of using AR in the teaching process are discussed. Mann-Whitney U-test proved the effectiveness of the use of AR for laboratory works in physics by students majoring in "Mathematics", "Computer Science", and "Cybersecurity".

Keywords

complementary reality, mobile addition, physics, educational process, physics and mathematics education

1. Introduction

Today's realities suggest that most students studying university physics feel a certain tension and dissatisfaction. On the one hand, the weak level of school knowledge, as evidenced by the high school graduation examinations, is a factor. Thus, in 2020, only 9% of school graduates took the External Independent Examination in Physics. The average score on the External Independent Examination evaluation results is 138.4, which is much lower than many other school subjects [1].

AREdu 2021: 4th International Workshop on Augmented Reality in Education, May 11, 2021, Kryvyi Rih, Ukraine

✉ kiv.arnold20@gmail.com (A. E. Kiv); v.bilous@kubg.edu.ua (V. V. Bilous); d.bodnenko@kubg.edu.ua (D. M. Bodnenko); d.horbatovskiy@kubg.edu.ua (D. V. Horbatovskiy); o.lytvyn@kubg.edu.ua (O. S. Lytvyn); v.proshkin@kubg.edu.ua (V. V. Proshkin)

🌐 <https://ieeexplore.ieee.org/author/38339185000> (A. E. Kiv); <http://eportfolio.kubg.edu.ua/teacher/1308> (V. V. Bilous); <http://eportfolio.kubg.edu.ua/teacher/244> (D. M. Bodnenko);

<https://fitu.kubg.edu.ua/pro-fakultet/komanda/763-1.html> (D. V. Horbatovskiy);

<http://eportfolio.kubg.edu.ua/teacher/301> (O. S. Lytvyn); <http://eportfolio.kubg.edu.ua/teacher/556> (V. V. Proshkin)

🆔 0000-0002-0991-2343 (A. E. Kiv); 0000-0001-6915-433X (V. V. Bilous); 0000-0001-9303-6587 (D. M. Bodnenko); 0000-0002-7828-4774 (D. V. Horbatovskiy); 0000-0002-5118-1003 (O. S. Lytvyn); 0000-0002-9785-06123 (V. V. Proshkin)

© 2021 Copyright for this paper by its authors.
Use permitted under Creative Commons License Attribution 4.0 International (CC BY 4.0).
CEUR Workshop Proceedings (CEUR-WS.org)



On the other hand, students' poor understanding of the discipline's meaning due to emotional non-acceptance of the teaching material and limited equipment in the laboratories of most Ukrainian universities [2]. This leads to the fact that many students do not understand the links between physical phenomena and processes and do not see the possibility of using physics to solve professional tasks and recognize the real world. One area of modernization of physics teaching in the university is the use of AR technology, which allows conducting physical experiments in the absence of the necessary equipment. AR provides an ability to move, wrap, zoom 3D models, view them under any object, combine and separate virtual objects, modeling of processes and phenomena, etc. Thus, complementary reality creates an atmosphere of excitement in problem-solving and in the environment of experimentation, helping to visualize complex processes and laws that are difficult or even impossible to achieve without special tools.

But at present, the use of AR in the process of physics teaching at the university is not systematic, and the majority of available mobile extensions or computer programs are limited to the school physics course. This makes the theoretical foundation of principles and approaches to the creation and use of AR at the high school level on the one hand; and, on the other hand, the development of apps with the material of a suitable level, and structure highly relevant.

The theoretical and practical aspects of teaching physics in the university are described by Bushuev et al. [3], Korobova et al. [4], Lozovenko et al. [5], Tsekhmister et al. [6], Velychko and Shulga [7], Zavrazhna et al. [8] and others. Particular attention to the improvement of methods of physical experimentation is paid by Boyes et al. [9], Han [10], Laouina et al. [11], Lu [12], Martyniuk et al. [13], Riggi et al. [14], Seliverstov et al. [15], Vallmitjana [16], Zhao et al. [17] and others.

Studies of the use of digital technologies in physics teaching deserve attention. Thus, Merzlykin [18] has developed a methodology for using digital technologies to develop research competencies of high school students in the process of professional education of physics.

Velychko [19] has substantiated the feasibility of using new state-of-the-art optics equipment and developed methods and techniques of performing demonstration and laboratory investigations on its basis combined with modern information technologies and computer devices for their implementation.

Velychko et al. [20] revealed the approaches and principles of virtual software support in the training of future physics teachers.

Recently, a number of studies have been implemented that reveal the potential of AR in the learning process. Thus, Blevins [21] examines the problem of enhancing students' digital literacy in the AR process. The author explores the use of one Augmented Reality (AR) software to support students composing AR and become familiar with concepts relevant to other composing occasions. He presents a scaffolded process involving analysis and composition, focusing instruction and discussion on the composing concept of the layer. Kurilovas [22] researched the quality evaluation and personalisation of virtual reality/augmented reality/mixed reality. Evaluation of quality of VR/AR/MR platforms/environments should be based on (a) applying both expert-centred (top-down) and user-centred (bottom-up) quality evaluation methods and (b) separating 'internal quality' criteria, and 'quality in use' criteria in the set of quality criteria (model).

Akçayır and Akçayır [23] identify the advantages and disadvantages of using AR in the

educational process. Moreover, theoretical and methodological principles of using AR are given by Babkin et al. [24], Bacca et al. [25], Fidan and Tuncel [26], Kolomoiets and Kassim [27], Kramarenko et al. [28], Lavrentieva et al. [29, 30], Mintii and Soloviev [31], Nechypurenko et al. [32, 33], Palamar et al. [34], Petrovych et al. [35], Rashevskaya et al. [36], Rashevskaya and Soloviev [37], Semerikov et al. [38], Striuk et al. [39], Tarasenko et al. [40], Vakaliuk and Pochtoviuk [41], Zelinska et al. [42], Zinonos et al. [43] etc.

Recently, a low number of works have been implemented that show the use of AR as educational technology in the physics teaching process. Thus, the paper [44] states that introduction of the augmented reality technology in the training process at higher educational institutions increases learning efficiency, facilitates students' training and cognitive activities, improves the quality of knowledge acquisition, provokes interest in a subject, promotes development of research skills and a future specialist's competent personality. The methodology of use of the augmented reality for the development of a health-preserving competence of a physical education teacher under conditions of post-graduate education was improved in the study [45]. Specific theoretical and practical aspects of the use of AR in physics teaching can be found in the works of the Cai et al. [46], Fidan and Tuncel [47], Strzys et al. [48]. An analysis of these works allows us to conclude that AR increases students' physics and mathematics competence, stimulates their cognitive activity, supports organization of independent work, prompts experimental work, etc. The results are the basis for the implementation of our study.

This article *aims* to develop a mobile application AR from the university course of physics and experimentally test the effectiveness of its use in the process of professional students' training.

In the process of research, the following methods have been used:

- analysis of scientific and pedagogical literature on the theoretical foundations of using the supplemented reality in the process of teaching physics in the university;
- analysis of online resources, educational literature to enlarge the capabilities of the augmented reality, especially the disclosure of its varieties, and tools for developing AR apps;
- studying and consolidation of pedagogical experience in using AR in the educational process;
- pedagogical experiment to improve the efficiency of mobile AR app application in physics teaching as well as specifying of advantages and disadvantages of AR application by the teachers and students;
- mathematical statistics methods (Mann-Whitney U-criterion).

2. Results and discussion

Even though Augment Reality is a relatively new information technology, it has already gained popularity among educators and students in the university environment. The main factor contributing to its dissemination is that it is unnecessary to have costly special equipment (eyepieces, telescope, monitor, etc.) to work with AR. Use a smartphone or tablet with a cost-free app. The principle of AR is that text, photo, video, or other information is applied to real-world objects to supplement them.

An analysis of the scientific literature [49, 50] allows us to conclude that AR technology has these variations:

1. *Marker technology* (characterized by a connection to a certain object). Marker-assisted reality is based on the use of markers (targets) for content creation. Images and 3D objects can be used as markers. The unique features of this technology are the high coverage of mobile devices and the ease of use.
2. *Markerless technology* (often referred to as positioning technology). Markerless doped reality allows the use of any flat surfaces for content creation. This technology is limited by the capacity of mobile phones supporting this functionality. It works seamlessly with iPhone 6s and newer versions and newer Android devices.
3. *Projection technology* (projection of light onto physical surfaces). Special apps help to create an interaction between man and projection by determining the moments of human contact with the light being projected.

Each of these variants is used in the educational process depending on the availability of appropriate equipment and the development of teachers' and students' digital competence.

Today there are a significant number of libraries and frameworks for working with augmented reality technologies. Most of them are available with open source code [51]. Complement the information presented in the previous study [51] and highlight the most valuable tools for working with software and games in augmented reality, and note the main characteristics of such devices (table 1).

Table 1
Tools for developing AR apps

Library/framework	Graphics	Development software	Operating system
Vuforia	2D, 3D, OpenGL	Vuforia SDK, Android Studio, X Code, Unity, Unreal Engine, Tizen Studio	Android, Apple, Windows, Linux
Google Sceneform/ ARCore	2D, 3D, OpenGL	Android Studio, X Code, Unity, Unreal Engine, Tizen Studio, 3Ds Max, Blender	Android, Apple, Windows, Linux
ARToolKit	2D, OpenGL	Android Studio, X Code, Unity, Unreal Engine, Tizen Studio, 3Ds Max, Blender	Android, iOS, Windows, Linux, Mac OS X, SGI
Wikitude	2D, 3D, OpenGL	Android Studio, X Code, Unity	Android, iOS
LayAR	2D, 3D, OpenGL	Android Studio, X Code, Unity	Android, iOS

In September and October of 2019, we assessed 15 experts – teachers of mathematics, informatics, and physics at the Borys Grinchenko Kyiv University, the Sumy State Pedagogical University named after A.S. Makarenko, and the Uman State Pedagogical University named after Pavlo Tichyny. As a result of summarizing the respondents' thoughts, we identified the benefits of using AR in the educational process. We believe that these advantages will be a guideline for the development and implementation of the mobile AR app:

1. Evidence (the main point is that the AR system can be studied and investigated in detail, from different angles).
2. Attention (students are more receptive to information that is more visualised).
3. Detachment (students who use AR are more focused on the teaching material and do not get distracted by other external factors).
4. Controllability (AR is a technology that allows the teacher to control the scenario of learning the material according to the students' abilities, the pace of learning the material, the errors that occur in the learning process, etc.).
5. Safety (the AR technology can be used to carry out complex physical, chemical and other experiments in a safe manner).
6. Effectiveness (implementation of the educational process with the help of AR increases the motivation of students, is practically oriented and acts as a guarantor of educational quality).

Summarizing the respondents' answers, we hypothesize that AR increases students' attention and motivation to the learning material, makes learning more rewarding and effective, links the solution of learning tasks with real experience and future professional activity, enhances the interaction between teachers and students, etc.

Moreover, the results of previous experimental studies by the authors of the article [51, 52, 53] indicate the effectiveness of the educational process with the use of augmented reality tools. We strongly believe that special attention should be paid to AR when studying natural and mathematical disciplines in the university (mathematics, physics, chemistry, information technology, etc.). In the context of distance education, which outweighs traditional full-time education, and insufficient level of equipment and materials in the university experimental laboratories AR technology itself can significantly affect the quality of university training of students of natural and mathematical and technical specialties.

Physics disciplines are usually experimental disciplines and involve practical and laboratory work. The article authors' experience in teaching physics shows that the use of devices of augmented reality and simulator programs aims to ensure understanding of physical phenomena and enable demonstration of the essence of physical processes, which are the basis for the study of these disciplines.

At the current stage of the development of network technologies, especially at a time of active and total adoption of distance learning technologies (through LMS, MOOCs, educational services), rapid growth is taking place [54]:

- simulators (e.g. <https://phet.colorado.edu>, <https://learning.ua/>);
- virtual laboratories (e.g. <https://stemua.science>, <http://modelscience.com/products.html>);
- augmented reality learning environments (e.g. <http://www.arloon.com/>),
- adaptive learning systems (e.g. <https://cerevrum.com/>),
- gamified applications (e.g., "Passcode" [55]), etc.

These AR resources and tools create an environment in which students become active participants in the physics learning process.

Practice shows that the use of AR technologies and simulations improves students' conceptual understanding of physical processes. For example, the simulator can be an effective intuitive tool for students to create working models of electric cells with an explanation of the nature of electrical phenomena. Besides, AR contributes to the development of logical and critical thinking of students, which can understand the nature of physical phenomena and processes. The work with AR must be independent of the time and geographical concept, which becomes particularly important in the conditions of distance learning.

In order to ensure the quality of physics teaching and increase students' interest, we solved the task of developing and using AR tools in the educational process.

1. To develop the mobile app, we used the following tools:
 - Android Studio (an integrated environment for the Android platform), SDK (a set of tools for developing utilities and documentation, which allows you to create apps for a particular technology or platform) and NDK (a set of tools allowing implementation of apps using languages such as C/C++/C# to adapt the app to various devices and to optimize the code);
 - Google Sceneform (ARCore, Sceneform Animation) is a library and framework for the visualisation of 3D models on controllable devices;
 - 3Ds MAX environment for developing 3D models (in our case, we use specific extensions to visualize models, mathematical description, and to animate elements of the model);
 - Core Animation (a library for the animation of 3D objects for augmented reality);
 - Asset Media Recorder (a library for working with sound in the Android Studio environment);
 - Ashampoo Music Studio (music, sound and voice recording software);
 - Google Translate Plugin (text translation plugin).

The authors' experience in developing apps allowed to use markerless technology of augmented reality and intrinsically relocate 3D objects. 3D models of objects in the 3Ds MAX environment are shown in figure 1, 2.

2. The next step of the research was the import of the model and its rendering in the Android Studio environment, which allowed us to create a mathematical description of the model through the tools ARCore, Google Sceneform and Core Animation (figure 3).
3. Having analyzed some AR apps in official digital markets, we decided to develop an audio accompaniment of augmented reality models to explain the material. For this, we used Ashampoo Music Studio to record the voice narration and Asset Media Recorder to import and connect the audio to 3D models (figure 4). Currently available languages: Ukrainian, Russian, English, Slovak, Italian. Up to 30 languages are planned for future versions.
4. A standard MediaPlayer library is connected for the audio software description (figure 5).
5. A plugin was included so that users of different languages could use the addendum.
6. The next step was to write the code for processing the sub-action and visualization with the connection of the system libraries to work with the smartphone. After ad-hoc testing of the app, a 3D model bank with explanations was created. It should be noted that the AR Physics tool can work on different platforms (Windows, Android) and devices (mobile phone, smartphone tablet, laptop, desktop PC), see figure 6.

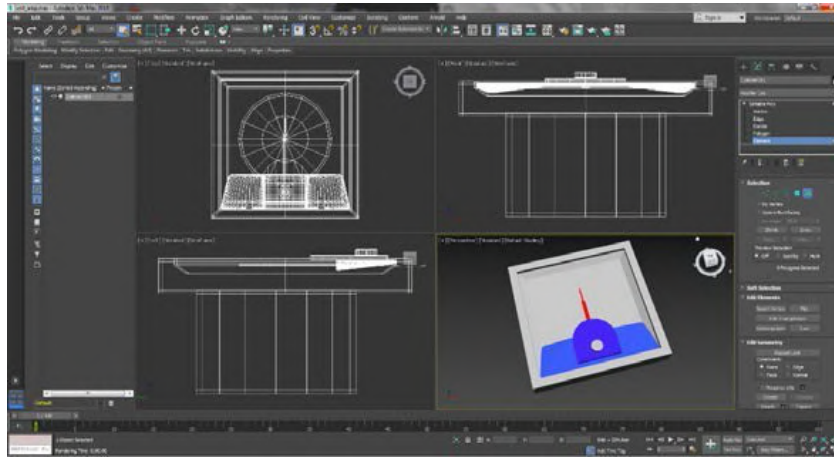

Figure 1: 3D Model of a voltmeter.

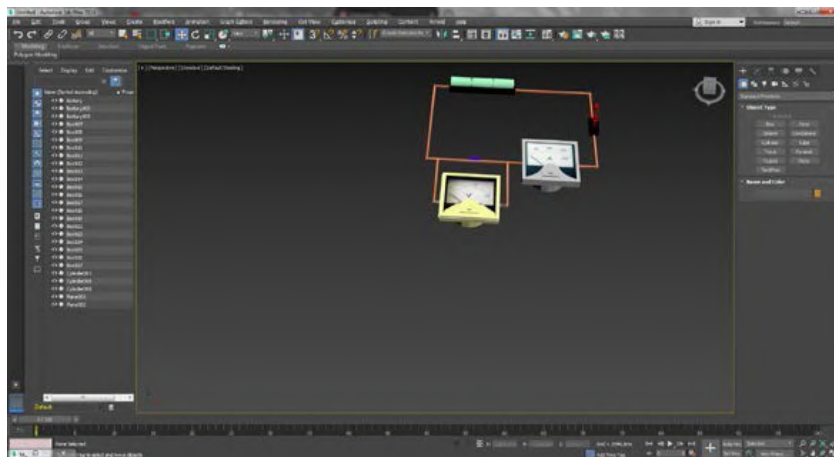

Figure 2: 3D Model of the implementation of the physical experiment.

The mobile AR Physics app focuses on teaching material using virtual laboratory experiments. It can be used to create electrical circuits and their upgrading, carried out virtual studies of the electric boiler at different values of indicators of the devices. Moreover, the AR Physics tool can serve as an intuitive and understandable game simulation with a set of the most popular elements of the electric boiler. The principle difference between this game and its existing analogs is that the characteristics of the electric components and the essence of physical phenomena and processes occurring in an open (or closed) electric stake are thoroughly explained.

AR Physics (at this stage of development) is suitable for the following topics:

- “Constant Electricity” of the module “Electricity and Magnetism” (used in the laboratory works on themes: “Ohm’s Law”, “Laws of series and parallel connection of conductors”);
- “Fundamentals of the Theory of Electronic Circuits” of the module “Logic Circuits” (used in the framework of the laboratory work on the themes: “Fundamentals of Electricity”,

```

zakonOma.java AndroidManifest.xml build.gradle (app) zakon_oma.xml model_anim.xml
package lab.dot_cube.ar.physics.lessons;

import ...

public class ZakonOma extends AppCompatActivity {

    private ArFragmnet arFragmnet;

    @Override
    protected void onCreate(Bundle savedInstanceState) {
        super.onCreate(savedInstanceState);
        setContentView(R.layout.model_anim);
        arFragmnet = (ArFragmnet) getSupportFragmentManager().findFragmentById(R.id.arFragmnet);

        // adding listener for detecting plane
        arFragmnet.setOnTapArPlaneListener((hitResult, plane, motionEvent) -> {
            Anchor anchor = hitResult.createAnchor();

            // adding model to the scene
            ModelRenderable.builder()
                .setSource(this, Uri.parse("zak_oma.ifb"))
                .build()
                .thenAccept(modelRenderable -> addModelToScene(anchor, modelRenderable));
        });

    }

    private void addModelToScene(Anchor anchor, ModelRenderable modelRenderable) {
        AnchorNode node = new AnchorNode(anchor);
        TransformableNode transformableNode = new TransformableNode(arFragmnet.getTransformationSystem()); // for moving, rotating object
        transformableNode.setParent(node); // need to attach to parent
        transformableNode.setRenderable(modelRenderable);

        arFragmnet.getArSceneView().getScene().addChild(node); // adding only parent node, as the child nodes will be added automatically
        transformableNode.select();
    }
}

```

Figure 3: 3D model description and rendering code.

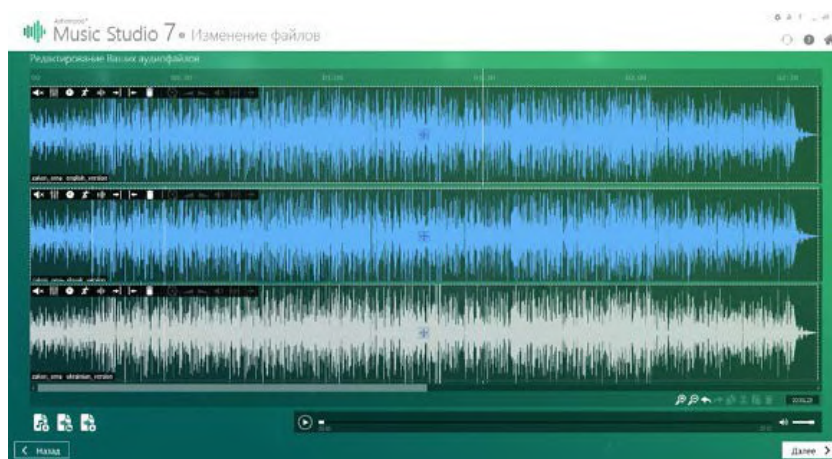

Figure 4: Software for professional recording, sound editing.

“Ohm’s Law”).

Implementation of the AR technology using the developed addendum was carried out at the Borys Grinchenko Kyiv University during the second semester 2019–2020 and the first semester 2020–2021 (January, March, September 2020 – full-time, other – distance learning). There were 93 students of the specialties “Computer Science”, “Cybersecurity” and “Mathematics”. In March 2020, the students were surveyed to find the advantages and disadvantages of using AR in

```

1 package lab.dot_cube.ar_physics.sounds; BelRoy, 14.01.2021 16:28 * basics
2
3 import ...
4
5 public class MainTheme extends Service {
6     MediaPlayer player;
7
8     @Override
9     public IBinder onBind(Intent intent) { return null; }
10
11     public void onCreate() {
12         player = MediaPlayer.create(this, R.raw.maintheme);
13         player.setLooping(true);
14     }
15
16     public int onStartCommand(Intent intent, int flags, int startId) {
17         player.start();
18         return Service.START_NOT_STICKY;
19     }
20
21     public void onDestroy() {
22         player.stop();
23         player.release();
24         stopSelf();
25         super.onDestroy();
26     }
27 }

```

Figure 5: Code for the creation of an audio accompaniment service.

physics teaching (you could choose any variants out of 10 offered or not select any).

The following results were obtained, ranked in descending order of respondents' votes by the number of respondents (figure 7).

According to the survey results, students find all of the AR characteristics we have suggested to be significant. Still, the most important are: providing a sense of reality (76 votes), an exciting learning experience (73 votes), time-saving, and space-saving (72 votes).

Among the shortcomings, students cited mainly technical problems related to the characteristics of smartphones, tablets or lack of access to fast Internet.

In addition, we contacted expert teachers who identified these problems with the use of AR:

- Lack of digital competence, which prevents the full use of AR tools in the teaching process;
- The inadequacy of teaching methods using AR;
- The limited amount of didactic material based on the use of AR.

As an analysis of the use of our addendum shows, the didactic materials, enriched with the possibility of AR, have a low advantage:

- The teaching methodology needs only correction, not a radical overhaul;
- The educational tools to which participants are accustomed do not change, but their possibilities are greatly enhanced.

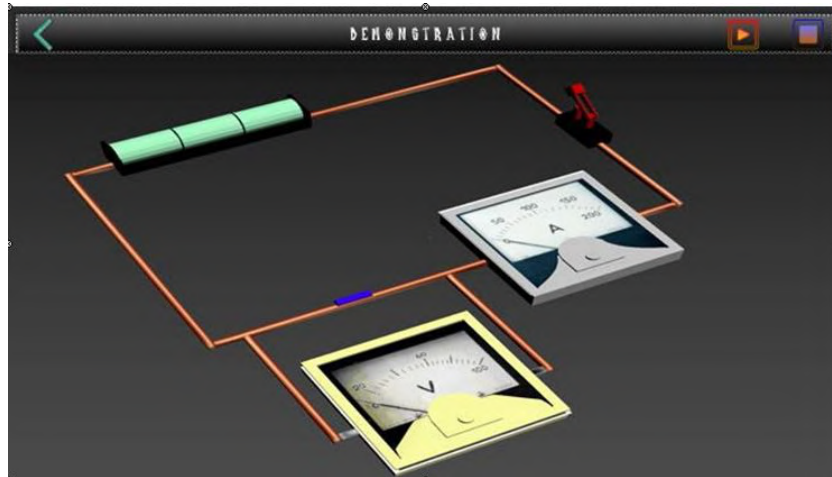

Figure 6: The animated model in the illuminator.

To determine the impact of AR Physics on the educational achievements of the students, we compared the results of laboratory works with the AR Physics tool (experimental group of 45 students) with the results of laboratory works, without AR (control group of 48 students). There were requested 4 laboratory works with maximum number of points – 40. The results of the students' laboratory works in physics are shown in figure 8.

The Mann-Whitney U-criterion is $U_{emp} = 109.5$. Since $U_{emp} < U_{cr1}$ (critical values $U_{cr1} = 706$ and $U_{cr2} = 845$) we accept the hypothesis of statistical validity of the difference in students' learning results of the experimental and control groups. Of course, it is too early to say that the very use of Augmented Reality affects the quality of students learning. In our opinion, Augmented Reality should be used in combination with other helpful tools, such as virtual laboratories, software simulators of physical experiments, etc. But the fact that Augmented Reality is an effective means of implementing the educational process in the current problems (lack of laboratory equipment, forced distance learning in a pandemic, low interest of students in physics) there is no doubt. An analysis of the use of mobile AR Physics app shows its usefulness for distance learning, especially for laboratory work. In face-to-face teaching, it is an effective means of adding reality to explaining theoretical material in lectures and practical exercises.

3. Conclusions

The article informs about the actuality of AR application in teaching physics in the university as the active tool for visualization of ideas about dynamics and interaction of physical phenomena processes, which influences students' comprehension of physics through emotional acceptance of educational material. A mobile AR Physics app has been developed, which enables virtual laboratory work. It can be used to create electrical circuits and modernization, conducting virtual studies of the electronic circuit at the different values of the devices. In addition, the AR Physics tool can serve as an intuitive game simulation with a set of the most common elements of the electrical circuit. The following tools were used to develop the mobile application: Android

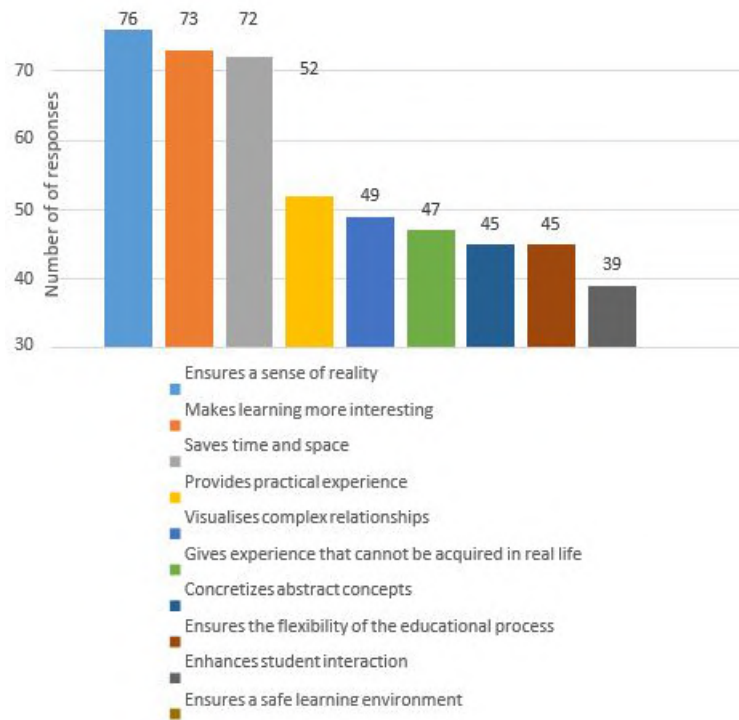

Figure 7: Benefits of AR in physics teaching.

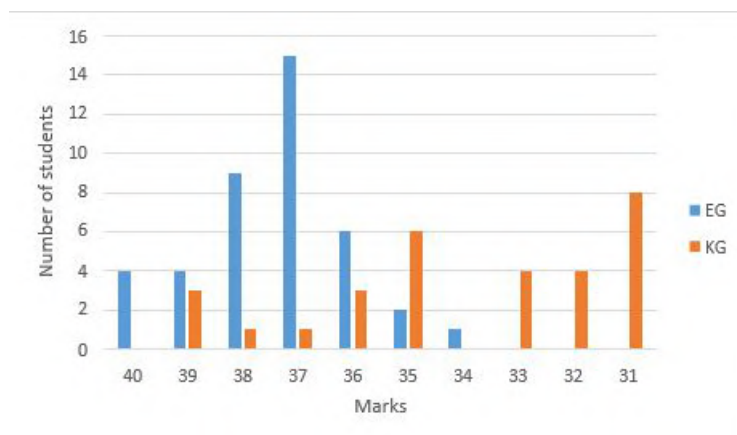

Figure 8: Results of students' laboratory work in physics

Studio, SDK, NDK, Google Sceneform, 3Ds MAX, Core Animation, Asset Media Recorder, Ashampoo Music Studio, Google Translate Plugin. The sequence of actions for the development of a mobile application is presented. The main difference between it and existing analogs is its rich voice of the characteristics of electrical elements and the essence of physical phenomena and processes. A bank of 3D models of elements of electrical circuits (power sources, consumers,

measuring devices, conductors) was developed.

As a result of the use of the mobile AR Physics app in the study of topics: “Direct electronic current”, “Fundamentals of the theory of electronic circuits”, advantages of AR in the educational process (ensuring a sense of reality, increasing student engagement, saving time and space, etc.) and disadvantages of AR (insufficient development of digital competence, inadequate teaching methods, limited didactic material, etc.) have been identified. The main reasons for this are the lack of a real sense of reality, increased student engagement, savings in time and space, etc.) and AR disadvantages (insufficient development of digital competence, inadequate teaching methods, limited didactic material, lack of technical capabilities of gadgets, absence of broadband Internet, etc.). The analysis of students’ learning outcomes has confirmed the effectiveness of using AR Physics in the educational process. The Mann-Whitney U-criterion was used for this purpose. Prospects for further research lie in the expansion of the tools of AR Physics, its implementation in the educational process in the study of various sections of physics (e.g. “Nature of Light. Optics”).

Acknowledgments

This article was published within the framework of the research topic “Theoretical and Practical Aspects of Mathematical Methods and Information Technologies in Education and Science”, CD No. 0116U004625, Department of Computer Science and Mathematics, Borys Grinchenko Kyiv University.

References

- [1] Ofitsiynyi zvit pro provedennia v 2020 rotsi zovnishnoho nezalezhnoho otsiniuvania rezultativ navchannia, zdobutykh na osnovi povnoi zahalnoi serednoi osvity. [Official report on conducting in 2020 an External Independent Evaluation of learning outcomes obtained on the basis of complete general secondary education], 2020. URL: <https://testportal.gov.ua/wp-content/uploads/2020/09/ZVIT-ZNO>.
- [2] Kontseptsiiia rozvytku pryrodnycho-matematychnoi osvity (STEM-osvity) [The concept of development of natural and mathematical education (STEM-education)], 2021. URL: <https://zakon.rada.gov.ua/laws/show/131-2021-%D1%80#Text>.
- [3] Y. Bushuev, A. Vasilyev, R. Lysenko, On teaching of the course of physics in the technical university, volume 1, Crimea, 2005, pp. 113–114. doi:10.1109/CRMICO.2005.1564831.
- [4] I. Korobova, N. Golovko, T. Goncharenko, O. Hniedkova, Experience of developing and implementation of the virtual case environment in physics learning by google services, CEUR Workshop Proceedings 2387 (2019) 358–369.
- [5] O. Lozovenko, Y. Sokolov, Y. Minaiev, “Search for Physics Laws”—A New Laboratory Course for Engineering Students, Advances in Intelligent Systems and Computing 1329 (2021) 361–370. doi:10.1007/978-3-030-68201-9_36.
- [6] Y. Tsekhmister, A. Chalyi, K. Chalyy, Teaching and learning of medical physics and biomedical engineering in ukrainian medical universities, volume 25, Springer Verlag, Munich, 2009, pp. 383–384. doi:10.1007/978-3-642-03893-8_110.

- [7] S. P. Velychko, S. V. Shulga, ICT tools for support of students' individual work in the study of quantum physics, *Information Technologies and Learning Tools* 65 (2018) 103–114. URL: <https://journal.iitta.gov.ua/index.php/itlt/article/view/2225>. doi:10.33407/itlt.v65i3.2225.
- [8] O. Zavrazhna, L. Odnodvoret, O. Pasko, A. Saltykova, Methodological bases for study nanotechnology in the general physics course of higher educational institutions, *Journal of Nano- and Electronic Physics* 9 (2017). doi:10.21272/jnep.9(5).05032.
- [9] E. Boyes, D. Hodgkinson, M. Houlden, The first step in an experiment to fully integrate computers into a university physics course, *European Journal of Physics* 8 (1987) 143–146. doi:10.1088/0143-0807/8/2/013.
- [10] C. Han, Reform of University Physics Experiment Course under the Combination of Big Data and Industrial Internet, *IOP Conference Series: Materials Science and Engineering* 735 (2020) 012076. doi:10.1088/1757-899X/735/1/012076.
- [11] Z. Laouina, L. Ouchauka, A. Elkech, M. Moussetad, M. Radid, Y. Khazri, A. Asabri, Manufacturing and developing remote labs in physics for practical experiments in the university, *Advances in Intelligent Systems and Computing* 1231 AISC (2021) 193–204. doi:10.1007/978-3-030-52575-0_16.
- [12] Z. Lu, Instruction and evaluation of university physics experiment under the theory of multiple intelligences, *Institute of Electrical and Electronics Engineers Inc.*, 2016, pp. 79–83. doi:10.1109/ISET.2015.24.
- [13] O. O. Martyniuk, O. S. Martyniuk, I. O. Muzyka, Formation of informational and digital competence of secondary school students in laboratory work in physics, *CEUR Workshop Proceedings* 2879 (2020) 366–383.
- [14] F. Riggi, P. La Rocca, S. Riggi, Muon decay: An old, yet alive experiment in the university physics curriculum, *European Journal of Physics* 37 (2016) 045702. doi:10.1088/0143-0807/37/4/045702.
- [15] A. Seliverstov, A. Slepko, Y. Starokurov, Classical demonstration experiments on electricity and magnetism at the faculty of physics of Moscow State University, *Bulletin of the Russian Academy of Sciences: Physics* 71 (2007) 1506–1509. doi:10.3103/S1062873807110068.
- [16] S. Vallmitjana, Attempts to encourage secondary students to initiate university studies of physics in the University of Barcelona based on experiments related to optics, volume 6034, *Changchun*, 2006, p. 603422. doi:10.1117/12.668178.
- [17] L. Zhao, C. Dai, Y. Wang, Reform on college physics experiment teaching for engineering students in agriculture and forestry universities, *Melbourne, VIC*, 2012, pp. 2007–2011. doi:10.1109/ICCSE.2012.6295470.
- [18] A. V. Merzlykin, Cloud technologies as tools of high school students' research competencies forming in profile physics learning, Ph.D. thesis, *Institute of Information Technologies and Learning Tools of the NAPS of Ukraine*, 2016.
- [19] S. P. Velychko, *Suchasni tekhnolohii u fizychnomu eksperymentuvanni z optyky: posibnyk dlia vchyteliv fizyky [Modern technologies in physical experimentation in optics: a guide for physics teachers]*, KLA NAU, Kirovohrad, 2014.
- [20] V. Velychko, E. Fedorenko, D. Kassim, Conceptual bases of use of free software in the professional training of pre-service teacher of mathematics, physics and computer science, *CEUR Workshop Proceedings* 2257 (2018) 93–102.

- [21] B. Blevins, Teaching digital literacy composing concepts: Focusing on the layers of augmented reality in an era of changing technology, *Computers and Composition* 50 (2018) 21–38. doi:10.1016/j.compcom.2018.07.003.
- [22] E. Kurilovas, Evaluation of quality and personalisation of vr/ar/mr learning systems, *Behaviour & Information Technology* 35 (2016) 998–1007. doi:10.1080/0144929X.2016.1212929.
- [23] M. Akçayır, G. Akçayır, Advantages and challenges associated with augmented reality for education: A systematic review of the literature, *Educational Research Review* 20 (2017) 1–11. doi:10.1016/j.edurev.2016.11.002.
- [24] V. V. Babkin, V. V. Sharavara, V. V. Sharavara, V. V. Bilous, A. V. Voznyak, S. Y. Kharchenko, Using augmented reality in university education for future IT specialists: educational process and student research work, *CEUR Workshop Proceedings* (2021).
- [25] J. Bacca, S. Baldiris, R. Fabregat, Kinshuk, S. Graf, Mobile augmented reality in vocational education and training, *Procedia Computer Science* 75 (2015) 49–58. doi:10.1016/j.procs.2015.12.203.
- [26] M. Fidan, M. Tuncel, Augmented reality in education researches (2012–2017): A content analysis, *Cypriot Journal of Educational Sciences* 13 (2018) 577–589. doi:0.18844/cjes.v13i4.3487.
- [27] T. Kolomoiets, D. Kassim, Using the augmented reality to teach of global reading of preschoolers with autism spectrum disorders, *CEUR Workshop Proceedings* 2257 (2018) 237–246.
- [28] T. Kramarenko, O. Pylypenko, V. Zaselskiy, Prospects of using the augmented reality application in STEM-based Mathematics teaching, *CEUR Workshop Proceedings* 2547 (2020) 130–144.
- [29] O. Lavrentieva, I. Arkhypov, O. Kuchma, A. Uchitel, Use of simulators together with virtual and augmented reality in the system of welders' vocational training: Past, present, and future, *CEUR Workshop Proceedings* 2547 (2020) 201–216.
- [30] O. Lavrentieva, I. Arkhypov, O. Krupskiy, D. Velykodnyi, S. Filatov, Methodology of using mobile apps with augmented reality in students' vocational preparation process for transport industry, *CEUR Workshop Proceedings* 2731 (2020) 143–162.
- [31] I. Mintii, V. Soloviev, Augmented reality: Ukrainian present business and future education, *CEUR Workshop Proceedings* 2257 (2018) 227–231.
- [32] P. Nechypurenko, T. Starova, T. Selivanova, A. Tomilina, A. Uchitel, Use of augmented reality in chemistry education, *CEUR Workshop Proceedings* 2257 (2018) 15–23.
- [33] P. Nechypurenko, V. Stoliarenko, T. Starova, T. Selivanova, O. Markova, Y. Modlo, E. Shmeltser, Development and implementation of educational resources in chemistry with elements of augmented reality, *CEUR Workshop Proceedings* 2547 (2020) 156–167.
- [34] S. P. Palamar, G. V. Bielienska, T. O. Ponomarenko, L. V. Kozak, L. L. Nezhyva, A. V. Voznyak, Formation of readiness of future teachers to use augmented reality in the educational process of preschool and primary education, *CEUR Workshop Proceedings* (2021).
- [35] O. B. Petrovych, A. P. Vinnichuk, V. P. Krupka, I. A. Zelenenka, A. V. Voznyak, The usage of augmented reality technologies in professional training of future teachers of Ukrainian language and literature, *CEUR Workshop Proceedings* (2021).
- [36] N. Rashevskaya, S. Semerikov, N. Zinonos, V. Tkachuk, M. Shyshkina, Using augmented real-

- ity tools in the teaching of two-dimensional plane geometry, *CEUR Workshop Proceedings* 2731 (2020) 79–90.
- [37] N. Rashevskaya, V. Soloviev, Augmented reality and the prospects for applying its in the training of future engineers, *CEUR Workshop Proceedings* 2257 (2018) 192–197.
- [38] S. O. Semerikov, M. M. Mintii, I. S. Mintii, Review of the course “Development of Virtual and Augmented Reality Software” for STEM teachers: implementation results and improvement potentials, *CEUR Workshop Proceedings* (2021).
- [39] A. Striuk, M. Rassovytska, S. Shokaliuk, Using Blippar augmented reality browser in the practical training of mechanical engineers, *CEUR Workshop Proceedings* 2104 (2018) 412–419.
- [40] R. O. Tarasenko, S. M. Amelina, S. O. Semerikov, V. D. Shynkaruk, Using interactive semantic networks as an augmented reality element in autonomous learning, *Journal of Physics: Conference Series* 1946 (2021) 012023. doi:10.1088/1742-6596/1946/1/012023.
- [41] T. A. Vakaliuk, S. I. Pochtoviuk, Analysis of tools for the development of augmented reality technologies, *CEUR Workshop Proceedings* (2021).
- [42] S. Zelinska, A. Azaryan, V. Azaryan, Investigation of opportunities of the practical application of the augmented reality technologies in the information and educative environment for mining engineers training in the higher education establishment, *CEUR Workshop Proceedings* 2257 (2018) 204–214.
- [43] N. Zinonos, E. Vihrova, A. Pikilnyak, Prospects of using the augmented reality for training foreign students at the preparatory departments of universities in Ukraine, *CEUR Workshop Proceedings* 2257 (2018) 87–92.
- [44] T. Hruntova, Y. Yechkalo, A. Striuk, A. Pikilnyak, Augmented reality tools in physics training at higher technical educational institutions, *CEUR Workshop Proceedings* 2257 (2018) 33–40.
- [45] O. Klochko, V. Fedorets, A. Uchitel, V. Hnatyuk, Methodological aspects of using augmented reality for improvement of the health preserving competence of a physical education teacher, *CEUR Workshop Proceedings* 2731 (2020) 108–128.
- [46] S. Cai, F.-K. Chiang, Y. Sun, C. Lin, J. J. Lee, Applications of augmented reality-based natural interactive learning in magnetic field instruction, *Interactive Learning Environments* 25 (2017) 778–791. doi:10.1080/10494820.2016.1181094.
- [47] M. Fidan, M. Tuncel, Integrating augmented reality into problem based learning: The effects on learning achievement and attitude in physics education, *Computers & Education* 142 (2019) 103635. doi:10.1016/j.compedu.2019.103635.
- [48] M. P. Strzys, S. Kapp, M. Thees, P. Klein, P. Lukowicz, P. Knierim, A. Schmidt, J. Kuhn, Physics holo.lab learning experience: using smartglasses for augmented reality labwork to foster the concepts of heat conduction, *European Journal of Physics* 39 (2018) 035703. doi:10.1088/1361-6404/aaa8fb.
- [49] V. Tkachuk, Y. Yechkalo, S. Semerikov, M. Kislova, Y. Hladyr, Using Mobile ICT for Online Learning During COVID-19 Lockdown, in: A. Bollin, V. Ermolayev, H. C. Mayr, M. Nikitchenko, A. Spivakovsky, M. Tkachuk, V. Yakovyna, G. Zholtkevych (Eds.), *Information and Communication Technologies in Education, Research, and Industrial Applications*, Springer International Publishing, Cham, 2021, pp. 46–67.
- [50] D. S. Shepiliev, S. O. Semerikov, Y. V. Yechkalo, V. V. Tkachuk, O. M. Markova, Y. O.

Modlo, I. S. Mintii, M. M. Mintii, T. V. Selivanova, N. K. Maksyshko, T. A. Vakaliuk, V. V. Osadchyi, R. O. Tarasenko, S. M. Amelina, A. E. Kiv, Development of career guidance quests using WebAR, *Journal of Physics: Conference Series* 1840 (2021) 012028. doi:10.1088/1742-6596/1840/1/012028.

- [51] V. Bilous, V. Proshkin, O. Lytvyn, Development of ar-applications as a promising area of research for students, *CEUR Workshop Proceedings* 2731 (2020) 205–216.
- [52] D. Bodnenko, H. Kuchakovska, V. Proshkin, O. Lytvyn, Using a virtual digital board to organize student’s cooperative learning, *CEUR Workshop Proceedings* 2731 (2020) 357–368.
- [53] V. Shamonina, O. Semenikhina, V. Proshkin, O. Lebid, S. Kharchenko, O. Lytvyn, Using the Proteus virtual environment to train future IT professionals, *CEUR Workshop Proceedings* 2547 (2020) 24–36.
- [54] A. Kiv, O. Merzlykin, Y. Modlo, P. Nechypurenko, I. Topolova, The overview of software for computer simulations in profile physics learning, *CEUR Workshop Proceedings* 2433 (2019) 352–362.
- [55] O. Prokhorov, V. Lisovichenko, M. Mazorchuk, O. Kuzminska, Developing a 3D quest game for career guidance to estimate students’ digital competences, *CEUR Workshop Proceedings* 2731 (2020) 312–327.

Using Blippar to create augmented reality in chemistry education

Yuliya V. Kharchenko¹, Olena M. Babenko¹ and Arnold E. Kiv²

¹Sumy State Pedagogical University named after A. S. Makarenko, 87 Romenska Str., Sumy, 40002, Ukraine

²Ben-Gurion University of the Negev, P.O.B. 653, Beer Sheva, 8410501, Israel

Abstract

This paper presents an analysis of the possibilities and advantages of augmented reality technologies and their implementation in training of future Chemistry and Biology teachers. The study revealed that the use of augmented reality technologies in education creates a number of advantages, such as: visualization of educational material; interesting and attractive learning process; increasing student motivation to study and others. Several augmented reality applications were analyzed. The Blippar app has been determined to have great benefits: it's free; the interface is simple and user-friendly; the possibility of using different file types; the possibility of combining a large amount of information and logically structuring it; loading different types of information: video, images, 3D models, links to sites, etc. Thus, convenient interactive projects were developed using the Blippar application, which were called study guide with AR elements, and implemented in teaching chemical disciplines such as Laboratory Chemical Practice and Organic Chemistry. Using such study guide with AR elements during classes in a real chemical laboratory is safe and does not require expensive glassware. The student interviews revealed that the use of the Blippar application facilitated new material understanding, saved time needed to learn material, and was an effective addition to real-life learning.

Keywords

augmented reality, augmented reality applications, chemistry education, Blippar, QR code

1. Introduction

Modern society is at a new stage in its development – in the era of informatization [1]. Students of higher education institutions are representatives of the modern generation, for whom it is quite natural to use their digital gadgets in all spheres of life – for entertainment and recreation, for ordering food and shopping, for travel. And, of course, in training.

For the modern generation of students, the educational process within augmented and virtual reality is natural and understandable.

Augmented reality (AR) technologies create unique opportunities in education [2]. By applying AR technologies to the educational environment, and by supplementing them with

AREdu 2021: 4th International Workshop on Augmented Reality in Education, May 11, 2021, Kryvyi Rih, Ukraine

✉ yuvlakhar@gmail.com (Y. V. Kharchenko); olenam.babenko@gmail.com (O. M. Babenko); kiv.arnold20@gmail.com (A. E. Kiv)

🌐 <https://scholar.google.com.ua/citations?user=zYiU4iMAAAAJ> (Y. V. Kharchenko);

<https://scholar.google.ru/citations?user=AeYIdfAAAAAJ> (O. M. Babenko);

<https://ieeexplore.ieee.org/author/38339185000> (A. E. Kiv)

🆔 0000-0002-8960-2440 (Y. V. Kharchenko); 0000-0002-1416-2700 (O. M. Babenko); 0000-0002-0991-2343 (A. E. Kiv)



© 2021 Copyright for this paper by its authors. Use permitted under Creative Commons License Attribution 4.0 International (CC BY 4.0).

CEUR Workshop Proceedings (CEUR-WS.org)

appropriate visual information, it is possible to create a visual model of educational material [3]. As a result, teaching and learning activities, independent research activities of students are intensified, especially in the context of distance learning; learning motivation and focus on both lessons and homework increases [4].

This was the reason for the introduction of AR technologies in the learning process and practical training of future Chemistry and Biology teachers and motivated us to create teaching materials with AR elements and to conduct classes using augmented reality applications to achieve educational goals.

2. Literature review

Over the last few years, a very large number of augmented reality applications have appeared at the disposal of educators. These applications differ in both purpose and complexity.

Yuen et al. [5] offer the following classification of AR learning applications:

- Discovery-Based Learning – applications that provide additional information about the object while considering it. Such AR applications are often used in museums, historical sites, sightseeing, astronomical education, etc.
- Object-Modeling – applications that use models that allow learners to visualize how an object would look from different viewpoints. Such applications are often used in the study of anatomy, architectural education.
- AR Books – learners use special devices such as special glasses. Such books contain 3D virtual presentations and interactive materials and assignments.
- Game-Based Learning – applications that allow to create and use AR games in learning. There are different ways to use AR in games. For example, marker technology is used in games where a flat board or map displays in a 3D shape and then can be viewed with a mobile device. These kinds of AR games can be used in the study of archeology, anthropology, history, geography. Other types of AR games offer interaction with AR objects. Such virtual objects are first created and then applied in specific locations in the real world.
- Skills Training – AR applications are used for training in specific areas, such as military or airplane maintenance.

According to the analysis of the literature data by Majeed and Ali [6], the use of AR applications in Discovery-Based Learning has the greatest number of positive effects in education. For example, such benefits as:

In recent years, more and more attention has been paid to the use of augmented reality technologies in teaching chemistry, starting from school [7]. Research shows that the AR tool is useful for improving student learning outcomes.

Belokhvostov and Arshanskiy [8] propose the following classification of augmented reality tools in chemistry teaching based on their content:

1. Ideal (augmented reality means textual, illustrative information (infographics, virtual demonstrations), as well as virtual chemical laboratories):

- a) cognitive-textual – means supplementing educational texts with small portions of cognitive material. Additional texts typically contain definitions of the concepts and terms that are used, the most important characteristics of the composition and structure of substances, information about the unique properties of substances and the chemical reactions, information from the history of chemistry, information about outstanding scientists-chemists, etc. As a means of augmented reality, cognitive texts may accompany textual or illustrative material on paper or electronic media. Using the possibilities of augmented reality when reading paper text significantly expands the didactic potential of the textbook and enhances its interactivity [9];
- b) virtual-illustrative – the human brain assimilates much better information presented in visual rather than textual forms. Therefore, in the methodology of teaching chemistry, various types of visualization (study notes, tables, frame models, etc.) have proven themselves well. An example of such an AR application is ISOMERS AR from Alchemie. This application allows user to build chains of different alkane isomers containing up to 10 carbon atoms. For each isomer its systematic name is displayed. So, the user can learn the concept of isomerism, the rules for the construction of alkanes and the rules for alkane nomenclature.
- c) virtual demonstration – special computer programs are used, which reproduce dynamic images on a computer. These images create visual effects that simulate signs and conditions of chemical processes. Such a program does not allow user interference in the algorithm that implements its work. The virtual demonstration is a type of virtual chemical experiment with great didactic capabilities:
- reproducing the subtle details of experiment unnoticed while a real experiment;
 - providing visual, dynamic and memorable illustrations of complex or dangerous chemical experiments;
 - simulating experiments require expensive reagents, dangerous and time-consuming;
 - simulating situations not available in a real chemical experiment.

For example, Elements 4D is a great free Android and iOS tablet or smartphone app that allows user to visualize 36 elements of the periodic table and information about them.

Another BiochemAR application offers visualization of complex biomacromolecules such as peptides and proteins [10].

- d) virtual research – virtual chemical laboratories, like virtual demonstrations, are a type of virtual chemical experiment. An example of a virtual laboratory is the “Entertaining Chemistry AR” mobile application, which allows to conduct virtual chemical experiments without special equipment and reagents. The program was created using augmented reality technology and contains colorful instructions for conducting a virtual experiment [8].

There is also an ARChemEx application that allows simulating chemical reactions [11]. Or ARchemy, which allows you to simulate some transformations in organic chemistry [12].

2. Real (video experiments, photographs of real substances, instruments, laboratory installations are supplemented by virtual objects). This includes real experiments in which the computer records the data obtained and processes them using special programs.
 - a) text-clarifying – involves the use of photos and videos showing real devices and laboratory equipment, chemicals and chemical reactions, chemical manufacturing equipment, but using AR technologies, which allow them to be supplemented with clarifying texts, that greatly enhances their didactic capabilities;
 - b) real-illustrative – illustrative photos of explosives, poisonous and flammable substances, as well as inaccessible chemical reactions are incorporated into educational texts on paper and electronic media by means of augmented reality technology. Real images of substances and chemical processes help motivate the subject studying, make the process of learning chemistry interesting;
 - c) real demonstration – videos containing a real-life chemical experiment are used;
 - d) real research – experiments are used, accompanied by computer processing of the obtained experimental data.

Different applications can be used to create augmented reality objects and elements while teaching chemistry. They vary in complexity, accessibility and functionality. For example, ARToolKit, HP Reveal (Aurasma), Vuforia, Augment platforms [13, 14].

It should be noted that Vuforia, in our opinion, may seem difficult for a person who has not previously encountered the creation of augmented reality objects. It also requires the installation of another Unity program. The Augment platform offers the possibility of creating augmented reality objects and using ready-made models which can be downloaded. However, it can only be used for 30 days for free. For further use is assumed a user fee.

The authors [13, 15] used HP Reveal (Aurasma), which is free, more understandable and convenient. However, in 2020 the developer of HP Reveal application announced the closure of the project and the end of application support, as well as the removal of all accounts.

There is also a free Blippar application [16, 17] that can be used in creating augmented reality and in teaching.

Through literature data and research analysis, we believe that the use of augmented reality technologies in the educational process creates a number of advantages [12, 8, 7, 18, 19, 20, 21, 22, 13, 15, 23, 24, 25, 26, 27, 28], among them:

- visualization of educational material, the possibility of displaying either the objects of the micro-world, or objects not available in the educational institution;
- using of modern teaching methods familiar to the subjects of the educational process makes the learning process more attractive and interesting; against such a positive background, the quality of information perception and comprehension increases;
- increasing students' motivation for research work;
- familiarization with laboratory equipment before starting to work with them;
- increasing the efficiency of students' independent work;
- providing an opportunity for students with special educational needs to participate in a joint project, to perform a practical task.

The potential of augmented reality technologies in distance education should be emphasized in particular. Without the possibility of face-to-face communication with the subjects of the educational process, the teacher has not only to present new material in videotelephony software programs, to provide texts and videos for study, but also to make educational material as accessible and comprehensible as possible, as well as constantly stimulate the interest of students [29, 30].

In our view, the augmented reality technologies have all these features, if they are used properly in the educational process.

3. Research methodology

In the process of research, the following methods were used.

To clarify the state of the problem and the objectives of the study: study and generalization of pedagogical experience and scientific pedagogical literature about the usage AR technologies in the educational process; analysis of online resources, methodological literature on the generalization of augmented reality opportunities and benefits; analysis of the available AR applications that can be used in teaching chemistry, were used.

In the practical part of the research: interviewing students; observing students while using Blippar to study some chemical disciplines.

4. Results and discussion

At the Department of Chemistry and Methods of Teaching Chemistry at Sumy State Pedagogical University named after A.S. Makarenko, applications for creating augmented reality have not previously been used in the educational process. But as such applications are increasingly gaining acceptance from scholars and teachers, we also decided to introduce augmented reality technologies in the teaching of chemistry disciplines that are taught to our students.

4.1. Creating projects in Blippbuilder

We analyzed several augmented reality applications. And chose Blippar. It should be noted that this application has a paid version that can be used for commercial purposes. But there is also a free version that cannot be used for commercial purposes, and projects created with it can only be viewed using a test code and will be watermarked, but it includes access to all features within Blippbuilder. However, these disadvantages are not significant given the advantages of the application.

Teacher can create AR objects with Blippbuilder [16]. If he is working with this application for the first time, it is necessary to register on the site. As our experience with Blippar has shown, the registration process is quite simple and formal, but necessary to use the application.

The application allows users to create an augmented reality both for viewing in a mobile application and in a browser. The first option is more appropriate in the classroom.

To start creating a project – blipp (figure 1), teacher needs to select a marker. This marker can be an image or a word. Students use this particular image or text as a marker. The program

recognizes it and displays augmented reality objects.

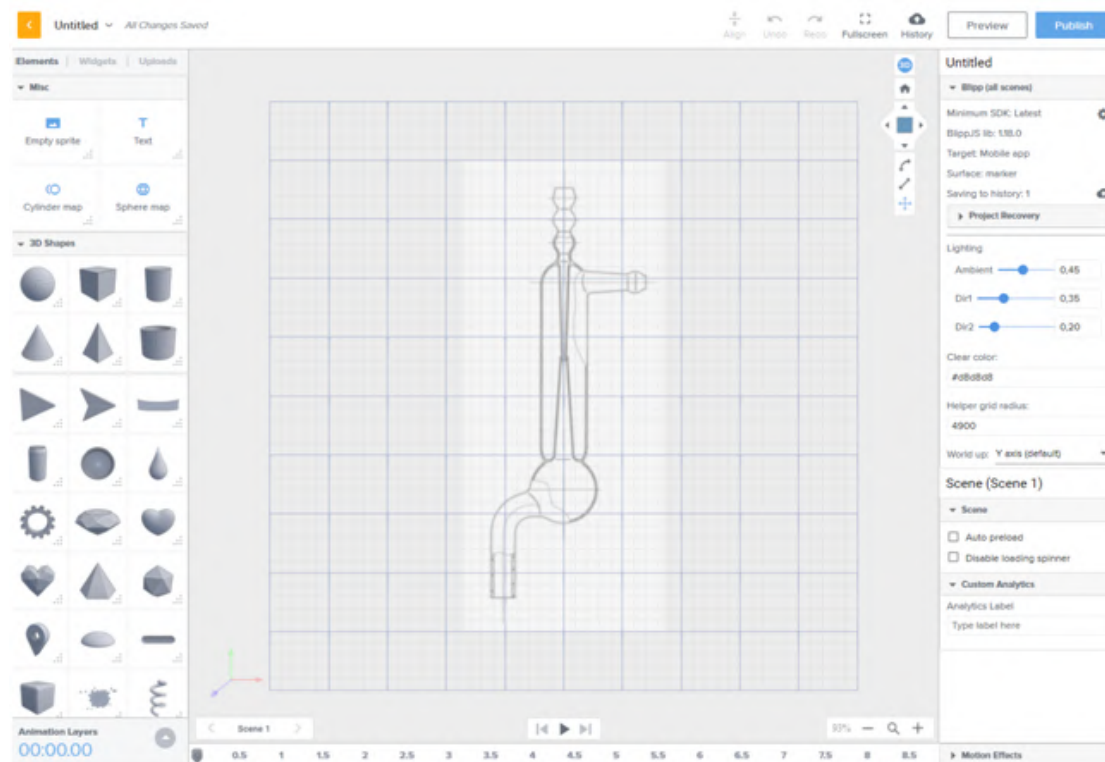

Figure 1: Getting started with a new project (blipp) in Blippbuilder.

The application offers ready-made models to use. And it is possible to upload your own models and other elements (images, documents of different formats, links to sites and social networks, audio and video files). Entering text in this application is not very convenient. By default, it is in one line. If the text is large, it is better to create it in a graphics editor and attach it as a picture.

It is convenient to create several scenes and place different elements on them. In this case, buttons for moving forward and backward are created on each scene (figure 2).

Once the blipp is finished, the application generates the code that is required for the subsequent use of the blipp.

4.2. The use of AR app in “Laboratory Chemical Practice”

This educational practice is intended for 1st year students majoring in 014 Secondary education (Chemistry).

Its goal is to acquire skills in working in a laboratory, mastering theoretical and practical knowledge and mastering methods for performing various types of work in a chemical laboratory. In practical classes, students need to familiarize themselves with the technique of carrying out

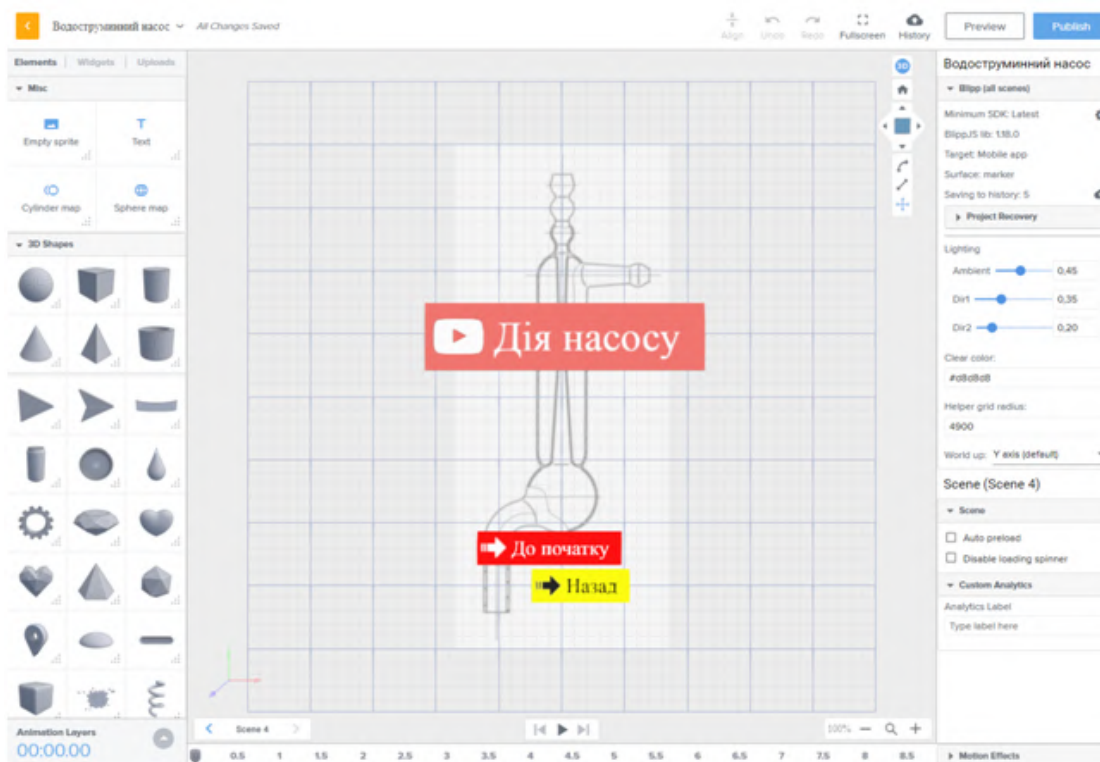

Figure 2: The project (blipp) contains 4 scenes and buttons for switching between them.

certain operations in chemistry, learn the basic techniques of working in a chemical laboratory and practice the skills of fulfilling life safety requirements. It is during this practice that students first become familiar with chemical glassware and equipment, their purpose and methods of handling them. Therefore, it is a very important component of the practical training of a chemist and future chemistry teacher. During distance learning, students do not have the opportunity to be in the laboratory and to work with laboratory glassware and equipment. The use of augmented reality makes it easy to solve this problem. In addition, da Silva et al. [19] shows the lab class in which the augmented reality application is used to study laboratory glassware is as effective as in a real laboratory. At the same time, using the application is safer and does not require expensive glassware.

According to student-centered learning students have the right for choosing methods and approaches to study new material in class. In practical classes we offer students a choice – how to study new material, what tools to use for this. One of these tools is the Blippar augmented reality app, and the second is a printed training material containing text, explanatory pictures and supplemented with a QR code.

To get acquainted with a new type of equipment, the operation with chemical laboratory glassware, the method of work students do not yet know, they choose one of two cards. One of them has an image – marker and the corresponding code for use in Blippar. The image needs to

be scanned using the Blippar app pre-installed on the mobile device.

When preparing for classes using AR application, we combined several different objects that related to one concept (phenomenon, process) in one project – blipp. Thus, we created an interactive study guide with AR elements, as we called it.

To work with such an interactive study guide with AR elements in class the teacher gives out a printed marker image – AR notecards, to the students and tells the code that matches it. To start working a Blippar application must be installed on students' mobile devices. The mobile version of Blippar requires at least 158 MB of gadget memory. Students enter the code, hover their smartphone camera over the marker and start working with augmented reality elements (figure 3).

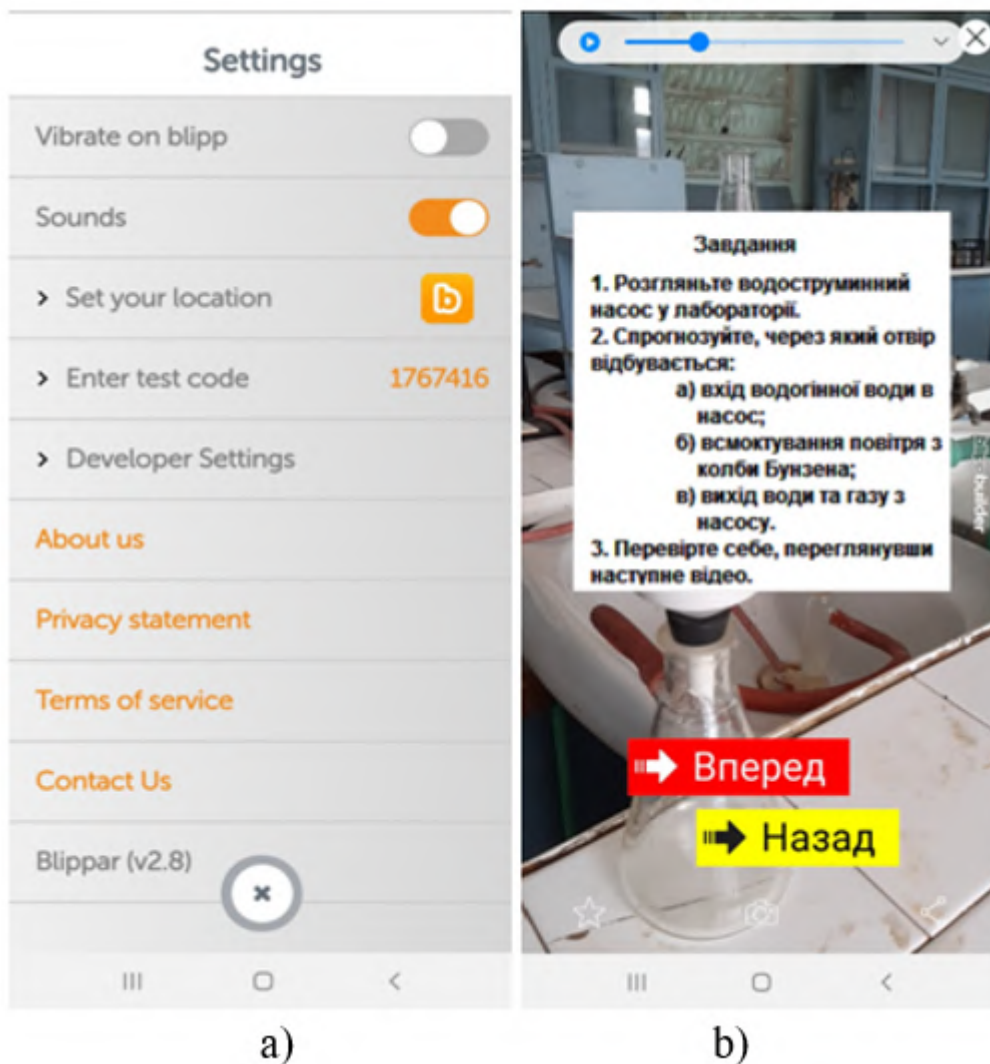

Figure 3: Working with Blippar: a) entering the code on a mobile device; b) completing assignments.

After the marker is recognized, all the material necessary for the lesson appears on the screen: a short text – a description of the chemical glassware, equipment or process that conforms to the pictures and signatures to them, video fragments, tests for self-control etc. This is what we call the study guide with AR elements. Navigation in it is quite convenient, there is always an opportunity to return to an obscure fragment and study it again carefully. After acquaintance with the description of the equipment and methods of working with it, the student can proceed directly to the implementation of the laboratory work.

The second card, which the student can choose, contains almost identical material – short text, drawings and captions to them – but printed on one or more sheets of paper. This is an instructional card, which is complemented by QR codes so that students can scan the code using their mobile device. Such cards are intended for those who prefer to work with already known learning tools (figure 4).

Водострумний насос

1.

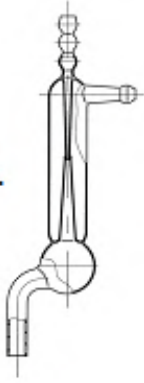

3. Завдання

1. Розгляньте водострумний насос у лабораторії.
2. Спрогнозуйте, через який отвір відбувається:
 - а) вхід водогінної води в насос;
 - б) всмоктування повітря з колби Бунзена;
 - в) вихід води та газу з насоса.
3. Перевірте себе, переглянувши наступне відео.

2. ПРИНЦИП ДІЇ

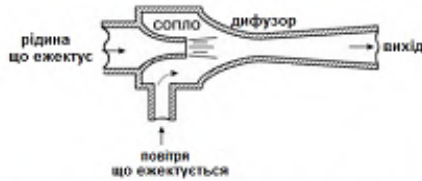

За принципом дії належить до ежекційних насосів (ежекторів) - (фр. éjecteur, від éjecter - викидати). Ежектор, працюючи за законом Бернуллі, створює в звузючому перетині знижений тиск одного середовища (рідини), що викликає підсмоктування в потік іншого середовища (повітря).

4. Перегляньте відео за QR-кодом



Figure 4: Instructional card with QR code.

Every lesson, we offered first-year students a free choice – work with the Blippar augmented reality application or with an instructional card that contains a QR code. Students often chose the first option. Instructional cards were also popular. Often, students took both a marker image and an instruction card. They understood that their content was essentially identical. But they

took both and used at their own discretion.

4.3. The use of AR app in “Organic Chemistry”

According to the educational programs at our university second-year students of the specialties 014 Secondary education (Chemistry) and 014 Secondary education (Biology) start studying organic chemistry.

The teaching organic chemistry experience at our department shows that the study of organic chemistry causes difficulties for students, primarily due to the large number of organic compounds and the peculiarities of their spatial structure. The lack of a system of ideas about the chemical, electronic and spatial structure of organic molecules and its effect on the substance properties leads to unproductive mechanical memorization of a large amount of factual material. Often, to understand the course and mechanism of a reaction, you must first understand how a molecule is made, especially when it comes to substances such as carbohydrates. Using augmented reality helps to meet this challenge [13, 22].

It became clear from the conversation with the students, that it is difficult for them to imagine the spatial structure of the cyclic form of monosaccharides, the process of creating pyranoses or furanoses. The use of visualization elements such as diagrams, images, videos during the study of these substances certainly facilitates the comprehension. But when watching such a video or image, students fail to understand something, they are often embarrassed to say it and ask to repeat. And if for some reason the student is not present at the lecture, he or she should study the omitted topic himself, using a textbook or methodological recommendation. And most traditional textbooks use 2D images that do not give a complete picture of the three-dimensional organization of molecules, and this makes it difficult for students to understand the material.

The COVID-19 pandemic [31] has become another challenge in organizing the study of organic chemistry. And the teachers had to revise the traditional teaching methods and introduce new approaches and methods into the teaching process. And augmented reality technologies in this situation have become one of the powerful tools that allow to collect different information in one place, to visualize objects and processes, and to replace real processes and experiments with virtual ones. After all, chemistry is not only a set of theoretical data, it is also an equally important practical component. Chemistry contains information about the spatial structure, the physical properties of substances, their aggregate state, interaction with other substances, the effects accompanying these interactions. And visualizing these aspects – real or virtual – is very important for successful learning.

You can link augmented reality objects with 2D images that can be found in textbooks, methodological recommendations or instruction cards using QR codes. Free convenient QR code generators are available online. Thus, it is possible to link the generated graphic code to any image, video or website. To use this code, students only need a smartphone with a video camera that can scan the code and redirect to the appropriate link. In our opinion, this method has one drawback. Only one element can correspond to one code.

For example, when studying the topic “Monosaccharides” we consider the cyclic form formation of monosaccharides and the stability of different conformational forms. Information cards containing several QR codes (figure 5) have been developed to better understand the material. Students can scan these codes and familiarize themselves with the scheme for the cyclic forms.



Figure 5: Instructional card on the topic.

The same cards have been developed for other topics. For example, for “Polysaccharides” to visualize the structure of these macromolecules and their reactivity. And for the reaction of cellulose nitration, using the QR code, students can watch a video of the experiment. A mixture of concentrated nitric and sulphuric acids is used to obtain nitrocellulose and must be handled very carefully. Nitrocellulose itself is a flammable substance. Before conducting such experiments, it is very important to thoroughly prepare for them, study the technique of conducting the experiment, and simulate it by means of augmented reality.

It should be noted that when such cards were offered for use for the first time, one student could not use them, since her smartphone could not recognize QR codes and it was necessary to install a special application, after that problems no longer arose. The rest of the students had no problems using QR codes.

To create augmented reality objects, we decided to use the Blippar application too.

Creating instructional cards (AR notecards) with Blippar allows to collect different objects of augmented reality in one place, linking them to only one marker. Moreover, such a marker can be an image, or it can be a word, for example, the name of a substance. This means that the student does not have to have a marker in front of them all the time. If the marker is a word, the student can scan it with the phone camera, even in the text, and see the result. As it mentioned above, for each marker, its own code is created and before scanning the marker, the student has to enter the appropriate code in the Blippar browser application on the phone.

For example, for the already described material on the spatial structure and stability of conformations for glucose a marker “Glucose” was created and assigned the corresponding code in the Blippbuilder application (figure 6). During the lesson the students get this code and they also get cards – AR notecards, on which both the marker and the code are indicated.



Figure 6: Marker created in Blippbuilder.

The marker selected is very simple. Students can find the term glucose both in the lecture notes and in the description of laboratory work and can scan it with the telephones even when pointing the phone camera at the computer screen, as shown in the figure 7, (which is very convenient while distance learning) and easily use the Blippar browser application to view the information.

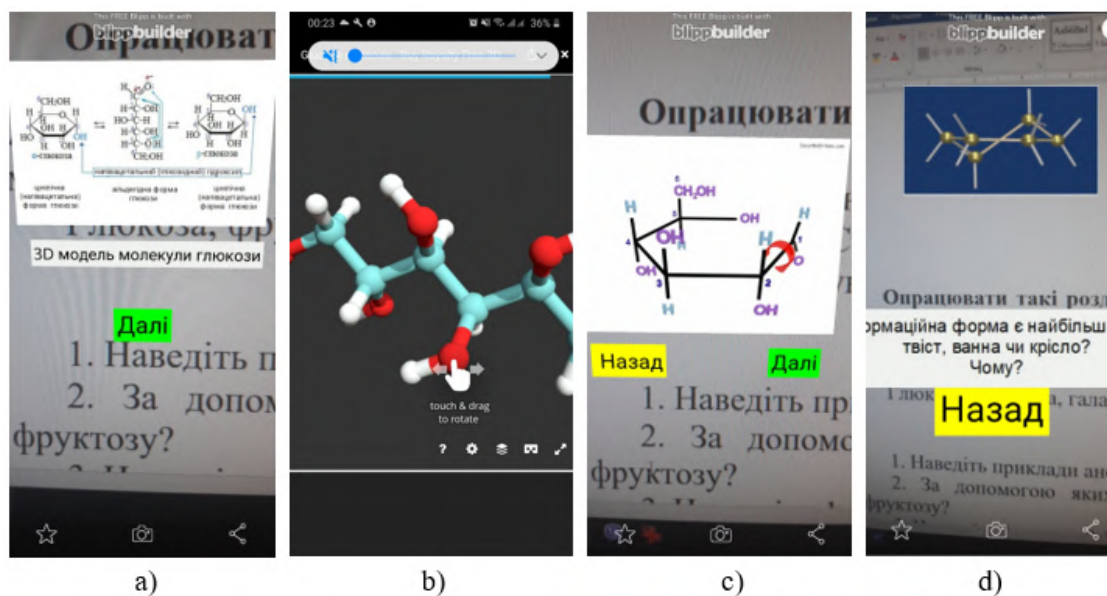

Figure 7: Displaying a blipp (study guide with AR elements) on the screen: a) scheme, b) 3D model of the molecule, c) video, d) task.

First, they see a schematic representation of the cyclic structure formation. They can also, by clicking on the corresponding image, go to the 3D model that allows the molecule to be viewed from different points. Then students can go to the animation that illustrates the cyclic structure formation. At this stage, if necessary, it is possible to return to the previous scene – the scheme and the three-dimensional model. Or they can go to the next one to see the transformation of one conformation into another. So, the application allows students to freely move from one scene to another, if they need to look through the information again. Or they can watch the video several times or stop it if they want to note something.

Thus, using just one word and a phone app, students can analyze the spatial structure of glucose. And they don't have to look for information from different sources and go to other sites to watch the video – all of this is in one study guide with AR elements.

The Blippar app allows users to upload videos. Therefore, the teacher can shoot the videos he wants and link them to the marker. Or he can use ready-made videos and link the site where they are to a marker.

Our experience of using Blippbuilder shows that it is better to create text fragments when creating blips not transparent, but on a colored background. This makes them more visible and user-friendly. And when scanning, it is better, but not necessary, that the marker is on a vertical

surface.

4.4. Student interview results

At the end of the classes that were held using AR study guides, we interviewed 25 students to find out what they thought about using augmented reality while studying organic chemistry and laboratory chemical practice. We have summarized all the responses received (figure 8).

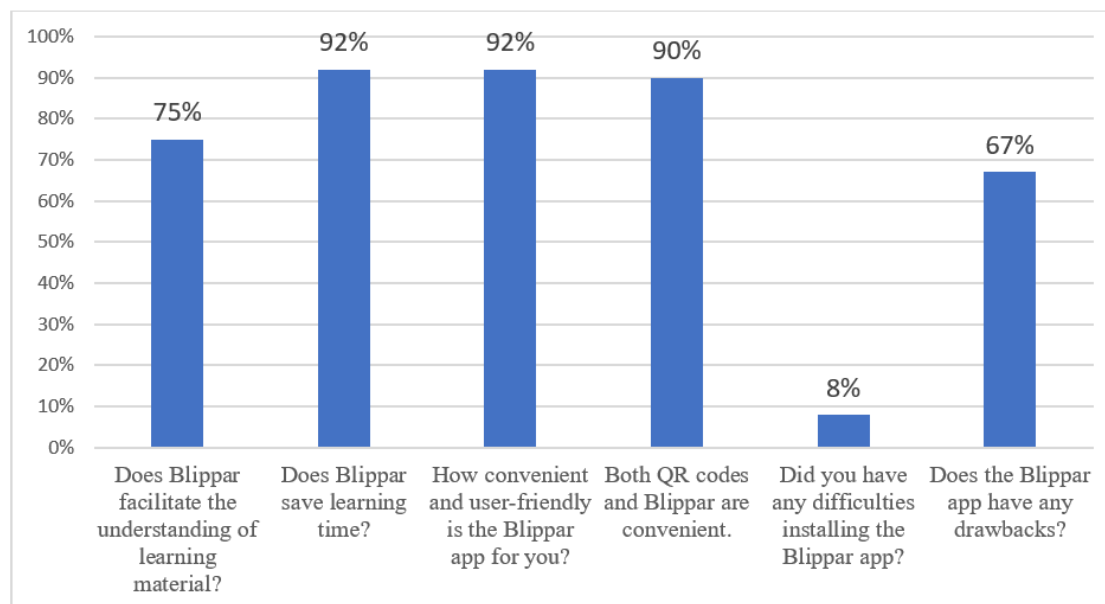

Figure 8: Student interview results (showing the percentage of those who answered positively).

To the question “Does Blippar facilitate the perception and understanding of learning material?” 75% of the respondents replied in the affirmative and added that AR technologies were an effective addition to real-life learning. Others noted that they did not see the benefits of using the Blippar application.

To the question “Does Blippar save time needed to learn material” 92% of the students answered affirmatively and argued that they did not need to search for information from different sources – everything that was necessary for the study was tied to one image-marker. 8% of students found it difficult to answer the question.

Answering the question “How convenient and user-friendly is the Blippar for you?” 92% of those surveyed said that the application was convenient and user-friendly. At the same time, when asked which option was more convenient for them: using QR codes or the Blippar browser, 90% students answered that both options were approximately equally convenient.

It should be noted that 8% of our students had technical problems installing and using the Blippar application or using QR codes.

When asked about the disadvantages of the Blippar application, 67% of students indicated the need to install the application on the gadget. Accordingly, 33% did not notice any.

Also, students expressed their wishes that we include markers and their corresponding codes in lecture notes, guidelines and recommendations for independent work,

5. Conclusions and directions of further research

Interviewing and observing students while using Blippar, as well as our work experience with this application, lead to the following conclusions.

The undoubted advantages of Blippar are:

- it is a free application if used for educational, not for commercial purposes;
- does not require much space to install;
- the interface is simple and user-friendly;
- any image or text can be used as a marker – Blippar allows to use a wide variety of file types;
- one marker – several elements of augmented reality – the teacher can combine a large amount of different information and logically present it;
- the application allows to upload different types of information – videos, images, 3D models, links to sites, etc., that is to create a study guide with AR elements;
- after scanning the marker, students should not hold the screen of their mobile device (smartphone, tablet) only in one position relative to the marker, they can take it aside – the augmented reality objects will not disappear;
- using the interactive study guide with AR elements, created in the Blippar for classes in a real-life chemical laboratory is safe and does not require expensive glassware.

With all the obvious advantages, working with Blippar has its drawbacks:

- to work with Blippar, students need to install it on their device;
- students need to enter a special code to work with the marker image, each marker has its own code;
- 3D models of chemical laboratory equipment and molecules of substances are very few, and they are not for free.

We believe that these disadvantages are insignificant compared to all the advantages of the Blippar application in creating augmented reality objects which it provides for education, including the study of chemistry.

Further studies are related to conduct of classes using the Blippar application for students of other courses and other specialties, checking their effectiveness; expanding the list of disciplines with using technology of augmented reality; to develop lecture notes, teaching aids for classes using AR technologies; and involving in future research students from schools and colleges those who are interested in studying chemistry in depth.

Acknowledgments

This research was conducted within the framework of the scientific theme “Methodological Support of Future Teachers” of the Department of Chemistry and Methods of Teaching Chemistry at Sumy State Pedagogical University named after A.S. Makarenko.

References

- [1] E. Fedorenko, V. Velychko, A. Stopkin, A. Chorna, V. Soloviev, Informatization of education as a pledge of the existence and development of a modern higher education, *CEUR Workshop Proceedings* 2433 (2019) 20–32.
- [2] T. Kolomoiets, D. Kassim, Using the augmented reality to teach of global reading of preschoolers with autism spectrum disorders, *CEUR Workshop Proceedings* 2257 (2018) 237–246.
- [3] O. Lavrentieva, I. Arkhypov, O. Krupskiy, D. Velykodnyi, S. Filatov, Methodology of using mobile apps with augmented reality in students' vocational preparation process for transport industry, *CEUR Workshop Proceedings* 2731 (2020) 143–162.
- [4] N. Rashevskaya, S. Semerikov, N. Zinonos, V. Tkachuk, M. Shyshkina, Using augmented reality tools in the teaching of two-dimensional plane geometry, *CEUR Workshop Proceedings* 2731 (2020) 79–90.
- [5] S. C.-Y. Yuen, G. Yaoyuneyong, E. Johnson, Augmented Reality: An Overview and Five Directions for AR in Education, *Journal of Educational Technology Development and Exchange* 4 (2011) 11. URL: <https://aquila.usm.edu/jetde/vol4/iss1/11>. doi:10.18785/jetde.0401.10.
- [6] Z. Majeed, H. Ali, A review of augmented reality in educational applications, *International Journal of Advanced Technology and Engineering Exploration* 7 (2020) 20–27. doi:10.19101/IJATEE.2019.650068.
- [7] S. Cai, X. Wang, F.-K. Chiang, A case study of augmented reality simulation system application in a chemistry course, *Computers in Human Behavior* 37 (2014) 31–40. doi:10.1016/j.chb.2014.04.018.
- [8] A. A. Belokhvostov, E. Y. Arshanskiy, Augmented reality in teaching chemistry: Possibilities and prospects of use 14 (2018) 131–140.
- [9] N. Honcharova, Technology of augmented reality in textbooks of new generation, *Problemy suchasnoho pidruchnyka* 22 (2019) 46–56. doi:10.32405/2411-1309-2019-22-46-56.
- [10] R.-J. Sung, A. T. Wilson, S. M. Lo, L. M. Crowl, J. Nardi, K. St. Clair, J. M. Liu, BiochemAR: An augmented reality educational tool for teaching macromolecular structure and function, *Journal of Chemical Education* 97 (2020) 147–153. doi:10.1021/acs.jchemed.8b00691.
- [11] M. C. Lam, H. K. Tee, S. S. M. Nizam, N. C. Hashim, N. A. Suwadi, S. Y. Tan, N. A. A. Majid, H. Arshad, S. Y. Liew, Interactive augmented reality with natural action for chemistry experiment learning, *TEM Journal* 9 (2020) 351–360. doi:10.18421/TEM91-48.
- [12] M. Abdinejad, B. Talaie, H. S. Qorbani, S. Dalili, Student perceptions using augmented reality and 3d visualization technologies in chemistry education, *Journal of Science Education and Technology* 30 (2021) 87–96. doi:10.1007/s10956-020-09880-2.
- [13] P. Nechypurenko, V. Stoliarenko, T. Starova, T. Selivanova, O. Markova, Y. Modlo, E. Shmeltser, Development and implementation of educational resources in chemistry with elements of augmented reality, *CEUR Workshop Proceedings* 2547 (2020) 156–167.
- [14] D. S. Shepiliev, S. O. Semerikov, Y. V. Yechkalo, V. V. Tkachuk, O. M. Markova, Y. O. Modlo, I. S. Mintii, M. M. Mintii, T. V. Selivanova, N. K. Maksyshko, T. A. Vakaliuk, V. V. Osadchyi, R. O. Tarasenko, S. M. Amelina, A. E. Kiv, Development of career guidance quests using WebAR, *Journal of Physics: Conference Series* 1840 (2021) 012028. URL: <https://doi.org/10.1088/1751-8113/1840/1/012028>.

- [//doi.org/10.1088/1742-6596/1840/1/012028](https://doi.org/10.1088/1742-6596/1840/1/012028). doi:10.1088/1742-6596/1840/1/012028.
- [15] K. N. Plunkett, A simple and practical method for incorporating augmented reality into the classroom and laboratory, *Journal of Chemical Education* 96 (2019) 2628–2631. doi:10.1021/acs.jchemed.9b00607.
- [16] Create & Make Augmented Reality Using Blippbuilder Tools – Blippar, 2018. URL: <https://blippar.com/blipp-builder#Blippbuilder>.
- [17] A. Striuk, M. Rassoavytska, S. Shokaliuk, Using Blippar augmented reality browser in the practical training of mechanical engineers, *CEUR Workshop Proceedings* 2104 (2018) 412–419.
- [18] Y.-C. Chen, A study of comparing the use of augmented reality and physical models in chemistry education, in: *Proceedings of the 2006 ACM International Conference on Virtual Reality Continuum and Its Applications, VRCIA '06*, Association for Computing Machinery, New York, NY, USA, 2006, p. 369–372. doi:10.1145/1128923.1128990.
- [19] B. R. da Silva, J. H. Zuchi, L. K. Vicente, L. R. Perin, M. B. Nunes, V. A. S. Pancraccio, W. B. Junior, Ar lab: Augmented reality app for chemistry education, *Nuevas Ideas en Informática Educativa* 15 (2019) 71–77. URL: http://www.tise.cl/Volumen15/TISE2019/TISE_2019_paper_61.pdf.
- [20] V. Gopalan, J. A. A. Bakar, A. N. Zulkifli, A brief review of augmented reality science learning, in: *The 2nd International Conference on Applied Science and Technology 2017 (ICAST'17)*, volume 1891 of *ICAST'17*, AIP Conference Proceedings, Kedah, Malaysia, 2017. doi:10.1063/1.5005377.
- [21] T.-C. Huang, M.-Y. Chen, W.-P. Hsu, Do learning styles matter? motivating learners in an augmented geopark, *Journal of Educational Technology & Society* 22 (2019) 70–81. URL: <https://www.jstor.org/stable/26558829>.
- [22] P. Nechypurenko, T. Starova, T. Selivanova, A. Tomilina, A. Uchitel, Use of augmented reality in chemistry education, *CEUR Workshop Proceedings* 2257 (2018) 15–23.
- [23] Y. Wang, N. Chen, Application of augmented reality technology in chemistry experiment teaching, in: *Proceedings of the 5th International Conference on Economics, Management, Law and Education (EMLE 2019)*, Atlantis Press, 2020, pp. 1145–1148. URL: 10.2991/aebmr.k.191225.223.
- [24] L. Midak, I. Kravets, O. Kuzyshyn, J. Pahomov, V. Lutsyshyn, A. Uchitel, Augmented reality technology within studying natural subjects in primary school, *CEUR Workshop Proceedings* 2547 (2020) 251–261.
- [25] L. Midak, I. Kravets, O. Kuzyshyn, K. Berladyniuk, K. Buzhdyhan, L. Baziuk, A. Uchitel, Augmented reality in process of studying astronomic concepts in primary school, *CEUR Workshop Proceedings* 2731 (2020) 239–250.
- [26] L. Y. Midak, I. V. Kravets, O. V. Kuzyshyn, L. V. Baziuk, K. V. Buzhdyhan, Specifics of using image visualization within education of the upcoming chemistry teachers with augmented reality technology, *Journal of Physics: Conference Series* 1840 (2021) 012013. doi:10.1088/1742-6596/1840/1/012013.
- [27] L. Y. Midak, I. V. Kravets, O. V. Kuzyshyn, T. V. Kostiuk, K. V. Buzhdyhan, V. M. Lutsyshyn, I. O. Hladkoskok, A. E. Kiv, M. P. Shyshkina, Augmented reality while studying radiochemistry for the upcoming chemistry teachers, *CEUR Workshop Proceedings* (2021).
- [28] L. Y. Midak, I. V. Kravets, O. V. Kuzyshyn, L. V. Baziuk, K. V. Buzhdyhan, J. D. Pahomov,

- Augmented reality as a part of STEM lessons, *Journal of Physics: Conference Series* 1946 (2021) 012009. doi:10.1088/1742-6596/1946/1/012009.
- [29] O. M. Babenko, Y. V. Kharchenko, H. Y. Kasianenko, Analysis of the teachers readiness for distance learning in Sumy and Sumy region, *Topical Issues of Natural Science and Mathematics Education* 1 (2020) 5–12. doi:10.5281/zenodo.4453031.
- [30] K. Polhun, T. Kramarenko, M. Maloivan, A. Tomilina, Shift from blended learning to distance one during the lockdown period using Moodle: test control of students' academic achievement and analysis of its results, *Journal of Physics: Conference Series* 1840 (2021) 012053. URL: <https://doi.org/10.1088/1742-6596/1840/1/012053>. doi:10.1088/1742-6596/1840/1/012053.
- [31] V. Tkachuk, Y. Yechkalo, S. Semerikov, M. Kislova, Y. Hladyr, Using Mobile ICT for On-line Learning During COVID-19 Lockdown, in: A. Bollin, V. Ermolayev, H. C. Mayr, M. Nikitchenko, A. Spivakovsky, M. Tkachuk, V. Yakovyna, G. Zholtkevych (Eds.), *Information and Communication Technologies in Education, Research, and Industrial Applications*, Springer International Publishing, Cham, 2021, pp. 46–67.

Immersive technology for training and professional development of nuclear power plants personnel

Oleksandr O. Popov^{1,2,3}, Anna V. Iatsyshyn¹, Andrii V. Iatsyshyn^{1,2},
Valeriia O. Kovach^{1,4}, Volodymyr O. Artemchuk^{1,2}, Viktor O. Gurieiev²,
Yulii G. Kutsan², Iryna S. Zinovieva⁵, Olena V. Alieksieieva⁶,
Valentyna V. Kovalenko^{1,7} and Arnold E. Kiv⁸

¹State Institution “The Institute of Environmental Geochemistry of National Academy of Sciences of Ukraine”,
34a Palladin Ave., Kyiv, 03680, Ukraine

²G.E. Pukhov Institute for Modelling in Energy Engineering of NAS of Ukraine, 15 General Naumova Str., Kyiv, 03164,
Ukraine

³Interregional Academy of Personnel Management, 2 Frometivska Str., Kyiv, 03039, Ukraine

⁴National Aviation University, 1 Liubomyra Huzara Ave., Kyiv, 03058, Ukraine

⁵Kyiv National Economic University named after Vadym Hetman, 54/1 Peremohy Ave., Kyiv, 03057, Ukraine

⁶National Academy of Sciences of Ukraine, 54 Volodymyrska Str., 01030, Kyiv, Ukraine

⁷Institute of Information Technologies and Learning Tools of the NAES of Ukraine, 9 M. Berlynskoho Str., Kyiv, 04060,
Ukraine

⁸Ben-Gurion University of the Negev, P.O.B. 653, Beer Sheva, 8410501, Israel

Abstract

Training and professional development of nuclear power plant personnel are essential components of the atomic energy industry's successful performance. The rapid growth of virtual reality (VR) and augmented reality (AR) technologies allowed to expand their scope and caused the need for various studies and experiments in terms of their application and effectiveness. Therefore, this publication studies the peculiarities of the application of VR and AR technologies for the training and professional development of personnel of nuclear power plants. The research and experiments on various aspects of VR and AR applications for specialists' training in multiple fields have recently started. The analysis of international experience regarding the technologies application has shown that powerful companies and large companies have long used VR and AR in the industries they function. The paper analyzes the examples and trends of the application of VR technologies for nuclear power plants. It is determined that VR and AR's economic efficiency for atomic power plants is achieved by eliminating design errors before starting the construction phase; reducing the cost and time expenditures for staff travel and staff training; increasing industrial safety, and increasing management efficiency. VR and AR technologies for nuclear power plants are successfully used in the following areas: modeling various atomic energy processes; construction of nuclear power plants; staff training and development; operation, repair, and maintenance of nuclear power plant equipment; presentation of activities and equipment. Peculiarities of application of VR and AR technologies for training of future specialists and advanced training of nuclear power plant personnel are analyzed. Staff training and professional development using VR and AR technologies take place in close to real-world conditions that are safe for participants and equipment. Applying VR and AR at nuclear power plants can increase efficiency: to work out the order of actions in the emergency mode; to optimize the temporary cost of urgent repairs; to test of dismantling/installation of elements of the equipment; to identify weaknesses in the work of individual pieces of equipment and the working complex as a whole. The trends in the application of VR and AR technologies for the popularization of professions in nuclear energy among children and youth are outlined. Due to VR and AR technologies, the issues of “nuclear energy safety” have gained new importance both for the personnel of nuclear power plants and for the training of future specialists in the energy sector. Using VR and AR to acquaint children and young people with atomic energy in a playful way, it becomes possible to inform about the peculiarities of the nuclear industry's functioning and increase industry professions' prestige.

Keywords

virtual nuclear power plant, virtual reality, augmented reality, specialist training, professional development, popularization of professions

1. Introduction

Despite the rapid development of alternative energy sources, nuclear energy remains a powerful source of electricity generation. Currently, Ukraine has a developed atomic energy industry, based on four operating nuclear power plants (NPPs): Zaporizhzhia, Khmelnytsky, Rivne, and South Ukraine, and for the next decades, according to the “Energy Strategy of Ukraine till 2035” [1] it is planned only to increase the capacity of this industry. NPPs are high-risk facilities, and their development prospects are closely related to their safe operation and protection of territories, civilians, and the environment on the site. Under various adverse circumstances (violation of technological processes, safety, and operating conditions, technological accidents and incidents, natural phenomena, terrorism and sabotage, military operation, etc.), various emergencies may occur at NPPs that pose a significant risk to the environment, health of staff and the population of the surrounding areas. Analysis of technological accidents by the threat to human life, by nature of the action, by the scale of destruction of buildings, by the amount of material and economic damage, etc., shows that the most dangerous are the accidents that cause radioactive and chemical contamination of the environment [2].

We agree with the publication [3], stating that although nuclear energy has created a new round in the history of human development, three large-scale nuclear accidents (Three Mile Island, Chernobyl, Fukushima Daiichi) caused global change leading to significant radioactive

AREdu 2021: 4th International Workshop on Augmented Reality in Education, May 11, 2021, Kryvyi Rih, Ukraine

✉ sasha.popov1982@gmail.com (O. O. Popov); anna13.00.10@gmail.com (A. V. Iatsyshyn); iatsyshyn.andriy@gmail.com (A. V. Iatsyshyn); valeriiakovach@gmail.com (V. O. Kovach); ak24avo@gmail.com (V. O. Artemchuk); viktor.gurieiev@ipme.com.ua (V. O. Gurieiev); kutsan.ug@ukr.net (Y. G. Kutsan); ira.zinovyeva@kneu.edu.ua (I. S. Zinovieva); l.alekseeva@ukr.net (O. V. Alieksieieva); vako88@ukr.net (V. V. Kovalenko); kiv.arnold20@gmail.com (A. E. Kiv)

🌐 <https://www.nas.gov.ua/EN/PersonalSite/Pages/Contacts.aspx?PersonID=0000010803> (O. O. Popov); <https://www.nas.gov.ua/EN/PersonalSite/Pages/default.aspx?PersonID=0000030359> (A. V. Iatsyshyn); <https://www.nas.gov.ua/EN/PersonalSite/Pages/default.aspx?PersonID=0000015808> (A. V. Iatsyshyn); <https://www.nas.gov.ua/EN/PersonalSite/Pages/default.aspx?PersonID=0000005869> (V. O. Kovach); <https://www.nas.gov.ua/EN/PersonalSite/Pages/default.aspx?PersonID=0000000337> (V. O. Artemchuk); <https://www.nas.gov.ua/EN/PersonalSite/Pages/default.aspx?PersonID=0000021472> (V. O. Gurieiev); <https://www.nas.gov.ua/EN/PersonalSite/Pages/default.aspx?PersonID=0000023263> (Y. G. Kutsan); <https://www.nas.gov.ua/EN/PersonalSite/Pages/default.aspx?PersonID=0000000128> (O. V. Alieksieieva); <https://www.nas.gov.ua/EN/PersonalSite/Pages/default.aspx?PersonID=0000030191> (V. V. Kovalenko); <https://ieeexplore.ieee.org/author/38339185000> (A. E. Kiv)

🆔 0000-0002-5065-3822 (O. O. Popov); 0000-0001-8011-5956 (A. V. Iatsyshyn); 0000-0001-5508-7017 (A. V. Iatsyshyn); 0000-0002-1014-8979 (V. O. Kovach); 0000-0001-8819-4564 (V. O. Artemchuk); 0000-0002-8496-3626 (V. O. Gurieiev); 0000-0002-0361-3190 (Y. G. Kutsan); 0000-0001-5122-8994 (I. S. Zinovieva); 0000-0002-9403-066X (O. V. Alieksieieva); 0000-0002-4681-5606 (V. V. Kovalenko); 0000-0002-0991-2343 (A. E. Kiv)



© 2021 Copyright for this paper by its authors.
Use permitted under Creative Commons License Attribution 4.0 International (CC BY 4.0).

CEUR Workshop Proceedings (CEUR-WS.org)

contamination, damage of natural and agro-ecological systems and public health. Therefore, safety is a necessary condition for the development of nuclear energy [2, 3].

In the new technological era, the digital state is becoming a normal state of functioning and developing many systems, areas, organizations, industries, and economies. Digitalization's primary purpose is to achieve the digital transformation of existing and creation of new sectors of the economy and modify spheres of life into new, more efficient, and modern ones [4]. High-tech production and modernization of industry with the help of digital technologies, the scale, and pace of digital transformations should become a priority of economic development [5]. In nuclear energy, digital technologies and successful projects, both foreign and domestic, need to be widely implemented.

Digital technologies are inevitably used in large industries and enterprises, and therefore staff training needs constant improvement. VR and AR technologies are an ideal tool for learning in the digital age. Because they are functional, accessible, it is possible to model complex situations that require adaptive thinking and specific skills. VR and AR technologies are already becoming the basis of training in an industrial environment as such activity becomes more effective and safer. The spread of immersion technology requires collaboration between industrial companies and VR and AR developers, ensuring that they meet various organizations' training and safety requirements [6].

The development and implementation of digital tools in energy companies and staff training are investigated in [3, 7, 8, 9, 10, 11, 12, 13, 14, 15, 16, 17, 18, 19]. Peculiarities of the functioning of potentially dangerous objects are described in [2, 20, 21, 22, 23, 24, 25, 26, 27]. Various aspects of the application of VR and AR technologies for training are investigated in publications [28, 29, 30, 31, 32, 33, 34, 35, 36, 37, 38, 39, 40, 41, 42, 43, 44, 45, 46, 47, 48, 49, 50, 51, 52, 53, 54, 55, 56]. As VR and AR technologies are continually evolving, there is a need to continue research into applying these technologies to NPP personnel's training and education and promoting nuclear energy professions among children and young people.

The **purpose** of the study is to analyze the features and best practices of using VR and AR technologies to improve NPP personnel's skills and promote the profession in nuclear energy.

2. Research results

2.1. Application of VR and AR technologies for educational purposes

The new evolutionary stage of society's development is called the technological era requiring the training of specialists who will be competitive and able to master the professions of the future. We believe that the use of digital technologies, particularly VR and AR, is essential in the training of specialists in the new technological era [45].

We will analyze research within the framework of applying VR and AR technologies to train future professionals and improve their skills.

The digital transformation of society has led to the need for future professionals to quickly adapt to changing activities, apply digital technology, and continuously improve their competence. At present, in particular AR, various technologies can be used to support employees in different industries in the formation of the necessary competencies [57]. The potential of AR as an innovative learning environment that can be applied to other cases is also revealed. It is

outlined what teaching and learning goals can be achieved using AR technology in teaching [36].

The analysis of scientific publications on the use of AR technology to support education, science, engineering, and mathematics was performed in the study of Ibáñez and Delgado-Kloos [35]. It is concluded that most AR applications for STEM learning offer research simulation activities. The considered programs offered several similar functions based on mechanisms of digital detection of knowledge for the consumption of information due to interaction with digital elements; most studies have evaluated the effect of AR technology on student learning outcomes; there are few studies with recommendations to help students carry out educational activities [35].

In [30] the tendencies of scientific publications for the last years are considered. The conducted analysis of bibliometric descriptions of articles related to the use of AR for educational purposes allowed us to conclude that mobile applications and paper-based materials with markers are the most convenient type of materials for AR, as they are easy to use and develop.

Syrovatskyi et al. [28] performed the historical and technological analysis of the experience of using AR tools for the development of interactive learning materials, characterized the software for designing AR tools for educational purposes, and identify technical requirements for the elective course “Development of virtual and augmented reality software”.

Yuen et al. [47] provides a classification of mobile applications with AR technology in education. The following options are described: books with AR technology, which form a bridge between the physical and digital world; educational games; educational programs; object modeling; applications for skills training.

The prospects of AR technologies and their use as components of the cloud environment are described in [29, 58]. AR technologies for education require the development of new methodologies, didactic materials, and curriculum updates [59]. The main aspects of using AR in the learning process are designing a flexible environment; adjustment of educational content for mastering the material provided by the curriculum; development of research methods that can be used in teaching together with the elements of AR; development of adaptive materials, etc. The researches [28, 60] concluded and emphasized that at the current stage of development of digital technologies, it is advisable to share Unity environment for visual design, Visual Studio or similar programming environment, as well as the platforms of virtual (Google VR, etc.) and augmented (Vuforia or similar) reality.

The application of AR technologies in higher education and the obtained results are described in the [32, 61]. AR technologies are widely used in higher education to visualize a design model or for the modeling process. Considering that many students have difficulty understanding the mechanical systems, starting with a two-dimensional design plan, the use of AR technologies is promising. AR can answer the problem of establishing a connection between the representation and the real system. The AR scenario is implemented on an electromechanical mechanism. This makes it possible to identify components and their location and study the mechanism and, thus, more comfortable identifying, for example, the kinematic circuit or the flow of power transmission. The experiment results with students of technical specialties showed that students who used AR technologies had better learning outcomes.

The peculiarities of applying AR technology in technical universities are described in the [48, 62]. Thus, the introduction of AR technology in technical universities' educational process

increases learning efficiency, improves the quality of knowledge acquisition, promotes students' learning and cognitive activity, and directs future professional research skills and competencies. Uriel et al. [49] also described how VR and AR technologies improve understanding of technical disciplines. One of the most critical problems in the first years of study in technical specialties is students' knowledge of basic scientific concepts. The study aimed to develop, design, and test VR and AR applications to improve basic scientific concepts for first-year students in technical universities.

2.2. VR and AR technologies application examples and trends in various industries

Industrial VR and AR is one of the critical concepts of industrial digitalization, which connects workers with the physical world through digital information. Figure 1 shows the VR application for industry. The AR market is expanding, but industrial implementation is still low. Large industrial companies seek to use AR, but they rarely use these technologies due to a lack of understanding of success factors. The study [13] identified the most crucial success factors and problems for implementing AR-based projects based on experiments. It is established that, although technological aspects are essential, organizational issues are more relevant for industry, which has not been described in detail in the scientific literature.



Figure 1: Example of application of VR for industry (<https://www.tssonline.ru/>).

Fauville et al. [14] describes the use of VR to raise awareness of climate change. At present, environmental literacy is essential for understanding threats such as global climate change. Most people do not understand the relationship between individual actions and their consequences for the environment, so VR technology can be a promising tool to solve these problems. Scientific publications devoted to the use of VR for the formation of ecological literacy of the population are considered.

AR technologies combine real-world images with virtual information such as 3D models or sounds. The use of AR technologies to solve various archeology problems and present tourists with ancient cultural heritage sites is described in the study [15]. As far as the AR technology is implemented using mobile phones, tablets, or smart glasses, tourist groups can examine ancient objects in the form they were in the past. The study aimed to improve video images obtained

by drones to create 3D models of Roman baths, an important cultural heritage site in Turkey. To do this, two different tracking techniques were introduced: GPS-based drone tracking and monocular camera-based tracking.

The research [63] presents various examples of the application of VR in power engineering. In Scotland, there is a VR laboratory for the training of wind farm personnel. This laboratory was created to improve the training system and professional development of personnel to work with offshore wind turbines. The laboratory focuses on virtual projections of real installations. It developed the facility's digital model so that local college students could get a detailed understanding of maintenance, diagnostics of malfunctions, and repair of the turbine. Classes are held in the VR laboratory, which uses a particular visualization system: the user sees their own hands and feet simultaneously with the generator's three-dimensional image. The physical movements are correlated with the virtual world. That is, students and staff undergoing internships can inspect the turbine using a simulation. You do not need to go to the sea. In such conditions, risks are reduced, and there is an opportunity to practice skills and train [63].

Also, a significant reduction in costs should be considered when applying virtual simulators instead of training using existing equipment. Wearing of equipment is minimized, risks of early/emergency failure of separate elements of a working complex are excluded. Thus, it is possible to reduce costs due to the absence of the need to spend money on expensive components and providing trips to remote practical facilities [63]. Additionally, VR technologies can be used in exhibition stands to create high-quality visualization of projects. For example, at exhibitions, visitors to the MHI Vestas booth before watching a movie about a wind generator are given branded climbing equipment: a helmet, seat belt, and safety vest to enhance the sense of the reality of what is happening [64].

2.3. VR and AR technologies application examples and trends for NPPs

Following the Fukushima Daiichi nuclear accident, the NURESAFE7 simulation platform was created based on the NURSIM platform for safety analysis, operation, and nuclear reactor design. Virtual Nuclear Power Plant (Virtual4DS) is an integrated simulation platform (figure 2) that covers the NPP environment, which is based on a digital reactor, information and data (provided by the digital society), consisting of digital traffic, digital meteorology, and data about earth's crust processes. Based on big data, mobile Internet, artificial intelligence, cloud computing, the platform, and other advanced digital technologies make it possible to perform simulations of multi-active operations, consider the evolution of nuclear accidents, use to support management decisions, anticipate emergencies, etc. [3].

Qin et al. [16] stated that the design, manufacture, assembly, operation, and decommissioning of nuclear devices are complex processes. VR technology can be used at all stages to save time and reduce costs. VR technology and its characteristics are described. The China Fusion Engineering Test Reactor (CFETR) is in the engineering design stage, but a significant analysis is needed to ensure it is safe. This includes the study of plasma physical dimensions, stability, exfoliating layer, discharge process, and engineering analysis of its electromagnetic, thermodynamic, and structural characteristics. Many software applications are used simultaneously, which generates a large amount of data, so you need a system that can manage such a large amount of data. VR technology certainly meets this requirement. The configuration of the CFETR VR platform (both

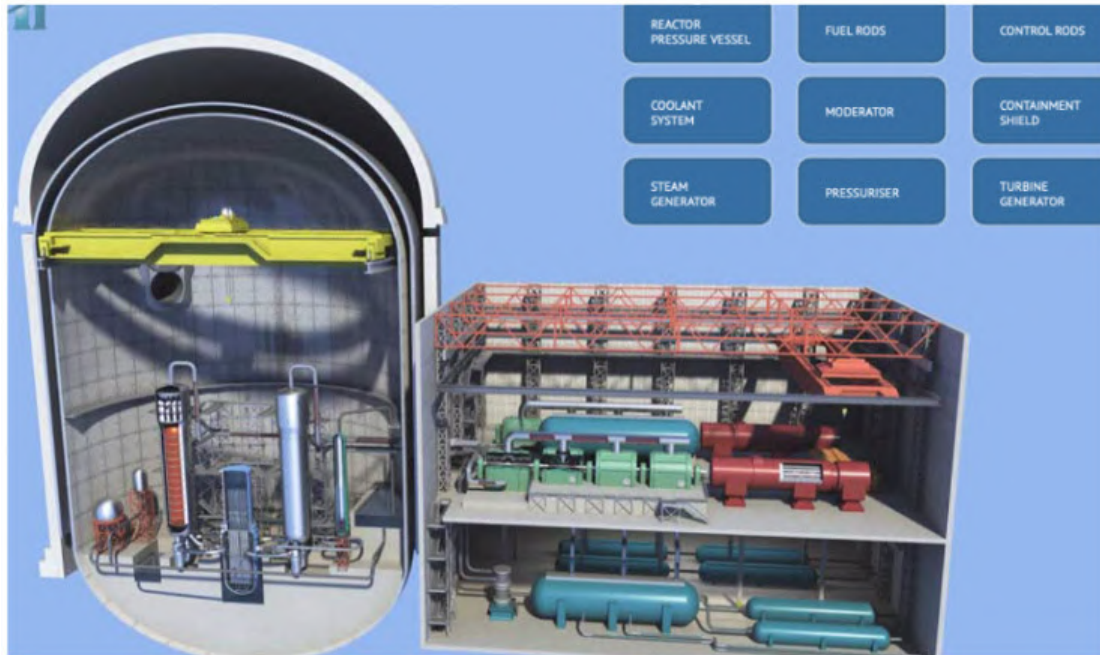

Figure 2: Virtual nuclear power plant [65].

hardware and software) is studied, and the further development of this platform is described [16].

Gabcan et al. [17] described a 3D simulation model of water infiltration for radioactive waste in VR. A virtual environment scenario was created for the radioactive waste infiltration model applied to the Abadia de Goiás repository (Brazil). The study aimed to introduce a three-dimensional 3D simulation model of the repository. With the help of VR technology, they sought to improve water infiltration inside the reservoir by pre-numerical simulations. The underground storage is presented in three different ways. It compares the variation of the amount of radioactive material in the water penetration scenario as a function of color change in the 3D simulation model. Visual modeling, obtained by changing the color shade and opacity, together with the difference in the height of the infiltrated liquid creates a physical perception of the probable scenario of risk. Thus, the virtual reality environment model has the advantage that it allows perceiving the corresponding overall results of penetration [17].

It is essential to use VR and AR technology to model an NPP construction project and a detailed presentation of various aspects of such a project. The study provides a brief overview of the latest technologies VR, AR in the design and construction industry; a summary of various methods and software used to convert the Building Information Model into VR, AR, etc.; a comprehensive review of the application of AR to effectively address multiple issues of construction project management. The roadmap for the introduction of AR technologies for the construction of AEC is presented [18].

The research [66] stated that at the beginning of 2020, the software and hardware complex

“Virtual Digital NPP with WWER reactor” was put into commercial operation. The Virtual Digital NPP’s key features are the following: it is possible to carry out calculations using the compact Russian-manufactured supercomputer. It is possible to model and test any modes of operation of power units with the WWER reactor (water-water energetic reactor) – from regular operation to complex abnormal situations as well as to change the mode of operation and predict changes in the state of the equipment without any consequences, which, in turn, allows to make existing NPPs safer at all stages of the life cycle. The platform of the software and hardware complex of the “Virtual Digital NPP” will be the core of modern simulators development for the NPP’s operational staff, which will positively affect the quality of personnel training and operational safety station. “Virtual Digital NPP” is the primary step towards creating full-featured “digital twins” of NPP power units, as the calculation modules are combined into a single system. On its basis, it is possible to build detailed models of NPP power units. Besides, more than ten calculation modules were developed and verified for modeling a wide range of processes and phenomena occurring in the NPP power unit’s equipment. Practical application should begin in 2020. Based on the complex, the development of the scenario of emergency training at the NPP is organized. It is planned to use the complex to analyze projects for the modernization of existing NPP power units [66].

The software and hardware complex “Virtual Digital NPP” (figure 3) in 2019 passed more than 100 independent and comprehensive tests. Experimental operation of the complex confirmed the possibility of using the complex for emergency drills and extensive emergency exercises, verification of control algorithms for NPP power units, confirmation of emergency instructions, and design decisions of the most reliable equipment. The basis for the creation of “Virtual Digital NPP” was the long-term experience (in the field of creating simulators and modeling of processes at NPP power units) of the All-Russian Research Institute for Nuclear Power Plants Operation [66].



Figure 3: The software and hardware complex “Virtual Digital NPP” [66].

The work [67] states that the software and hardware complex “Virtual Digital NPP” is an essential technology for Belarus because Belarusian NPP is being built within this project’s framework. This “Virtual Digital NPP” differs from foreign counterparts by a deeper degree of detail in the modeling of thermophysical processes that can occur at a real station, as well as relevant systems and equipment. The most crucial task of any nuclear power plant from the point of view of safety is to prevent the initiation and development of the processes that can lead to emergencies. Therefore, the virtual power unit can show how the real object’s security systems will respond with maximum accuracy to regular operation disruptions, emergency processes, including those caused by malfunctions of NPP equipment. Moreover, in contrast to the simulators used for teaching and training personnel, the processes at the virtual NPP are demonstrated with the maximum possible approximation to the natural laws of physics. The virtual station screens show all the devices provided by the design of the entire block control panel of the NPP, so there are many options for situations modeling [67, 68].

Besides, creating a virtual power unit made it possible to conduct experiments in cyberspace, which is not cheap. One of the advantages of a virtual NPP is the ability to model large-scale equipment, with which experiments in real conditions are not possible. However, a complete refusal to conduct field experiments is impossible for the following reasons: 1) running experimental confirmation of newly created equipment and systems are one of the requirements of regulatory documents; 2) experiments should be performed at a high technical level to replenish the verification base, which allows improving the “Virtual Digital NPP”. The use of a wide range of capabilities of “Virtual Digital NPP” allows not only to reduce the number of possible inconsistencies in the NPP design and check the interaction of systems during operation of the plant equipment in different modes before commissioning. As a result, it became possible to avoid expensive alterations and unjustified upgrades. Moreover, possible modernization of NPP power units during operation can now be checked first by a virtual power unit (figure 4), and only after receiving a positive result, implement it on real equipment [67].



Figure 4: Virtual power unit [67].

Currently, creating a virtual copy of a nuclear power plant (“digital twin”) is a difficult task that needs to be addressed in several aspects: creating a virtual 3D model; creating the simulators that will be a basis of a virtual model; introduction of product lifecycle management for centralization and organization of data. For a true digital twin to exist, a virtual model must be very accurate and include even the smallest components. Because NPPs have a life cycle of 60 to 70 years, operators must ensure the digital twin’s long-term reliability and viability. The digital twin combines several simulation tools, often created by different subcontractors. A successful digital twin would mean that all of these tools could be standardized to ensure compatibility [69].

In 2019, the GEMINA program was introduced, promoting research efforts using artificial intelligence and improved modeling tools to provide more flexibility in nuclear reactor systems, greater autonomy in operation, and faster iteration of the project. GEMINA has also set itself the ambitious goal of helping nuclear reactor developers reduce operating costs by ten times, mainly through predictive maintenance and model-based troubleshooting. GEMINA projects will focus on solutions for the reactor core’s care and operation, plant balance, or the entire reactor system [70].

Various projects for the development of “digital NPP twins” are described in [70]. The projects for which funding is allocated envisage: 1) the result of a digital copy of a high-temperature reactor with fluoride salt cooling; 2) the digital copies should provide continuous monitoring, early warning, diagnosis and forecasting of emergencies, etc.; 3) the assessment of potential risks, hazard analysis and safety and maintenance assessment to identify areas for optimizing the operation of NPPs; 4) the development of a multidisciplinary 3D model, which in combination with VR will test methods that optimize service and security; 5) provide a virtual test environment for demonstration/modeling of operations and maintenance strategies of nuclear reactors; 6) the digital copies will simulate a passive cooling system with internal thermal-hydraulic faults and a typical cooling circuit with different operating modes and control states [70].

The French companies operating in the nuclear industry have launched the *Reacteur numérique* project. This project aims to develop a “digital reactor” that can be used starting from design to decommissioning of nuclear power plants. Among the expected results of the project until 2023, there are two innovative products. The first is a digital reactor for instructor training, reflecting the unit’s physical phenomena and simulating various operational strategies. The instructors will use a web interface instead of a full-scale simulator. Instead of describing each system in detail, the model will reflect the installation’s operation as a whole. The second innovation is an improved simulation service platform for educational purposes, covering the entire life cycle: design, commissioning, operation, maintenance, and even deconstruction. The platform will facilitate a range of research, covering everything from routine operations to significant accidents. Training of NPP personnel should become more efficient, and staff training costs will be reduced [71].

The publication [72] concluded that currently, VR and AR technologies for nuclear energy are used in the following areas (figure 5): modeling of various atomic energy processes; operation, repair, and maintenance of NPP equipment, presentation of activities, NPP construction; staff training and education.

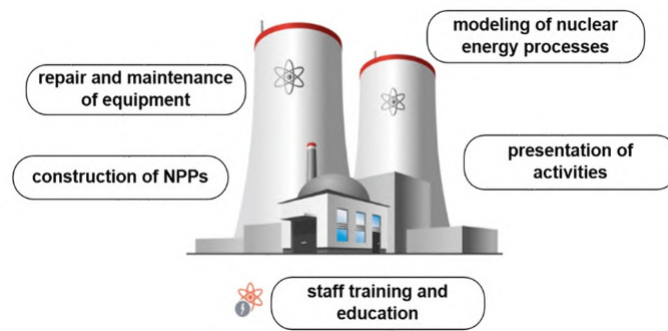

Figure 5: Areas of application of VR and AR technology for nuclear energy.

2.4. Peculiarities of application of VR and AR technologies for training of future specialists and advanced training of NPP personnel

NPPs are the object of critical infrastructure, so their reliability and safety, hence the personnel training, are subject to the highest requirements. VR technologies allow organizing such activity in the conditions close to real, and it is safe for participants and the equipment. VR technologies create the illusion of being inside a virtual environment and are cheaper than traditional learning equipment, and benefit from accessibility and ease of use [64]. VR is a handy tool that allows simulating any situation. With the help of VR, it is possible to test the security system and reproduce any regular processes to train employees and identify weaknesses in the work of individual elements of equipment and the work complex as a whole [63].

Reliable training is essential to ensure the operation of NPPs, which is the key to safe and productive activities. The cost of the slightest mistake in the energy sector can be incredibly high. To minimize such risks, special attention should be paid to training. The theory is essential, but it is nothing without good practice. VR systems are an effective simulator with which you can easily design any situation and work out a procedure to solve all possible problems. With the help of VR technologies, it is possible to 1) work out the procedure in an emergency mode; 2) work out the dismantling/installation of equipment elements; 3) optimize temporary costs for urgent repairs, etc. With the help of VR, you can visualize the project for collective acquaintance, further adjustment, and joint decision-making in the framework of corporate activities [63].

Kutsan et al. [46] substantiates the importance of using modern digital technologies to improve energy professionals' skills, including operational and dispatching personnel. The study justifies the need for the educational and methodological base, structure, and functions of the virtual research and training center for staff training in Ukraine's energy sector, including knowledge control, training, and critical competencies. The advantages of using a distributed environment for the organization of training and coaching of operational personnel with the help of modeling modes of operation of power systems in the virtual center are considered. To improve the skills of personnel in Ukraine's energy sector, virtual research and training center was designed, developed, and implemented, and its scientific support was provided. Besides, a full-featured mode web simulator has been developed and implemented.

One of the main tasks of simulation-based training is to reduce the time spent on competencies, to transfer high-level skills to each employee with maximum efficiency. With VR's help, employees are immersed in the epicenter of events to obtain the necessary equipment management and maintenance. VR technology provides benefits both for the study of a single sample of equipment and for the entire enterprise, especially using highly realistic three-dimensional process simulation. The same 3D models can be used in different scenarios, depending on additional learning requirements [6]. Interactive 3D applications allow you to organize training for remote or dangerous objects. A 3D model of the NPP unit eliminates the need to visit the facility for training: you can train in the office; the staff will not only be able to virtually explore the facility but also together with the instructor to play different scenarios [73].

A realistic and detailed VR learning environment helps to get to know the company and its work well before students appear to live for the first time. 3D graphics and sound give users a complete sense of immersion in the virtual world. Digital simulation devices and VR technology provide a similar gaming experience (this attracts the younger generation) and allow better assimilation of information [6].

The research [6] states that VR technologies are well suited for learning, as they provide immersion, better memory, and are cost-effective. The main advantage of simulation-based education is that the learning process is implemented in a continuous or long-repeated manner with the enterprise and students' security. Industrial enterprises are dangerous environments, and they are under constant exploitation. This fact dramatically complicates the organization of training with real equipment, especially when preparing for emergencies. Better-trained workers help reduce accidents, accident costs, and downtime. Investing in immersion training systems at an early stage of the equipment life cycle can maximize investment return [6].

The Nuclear Maintenance Applications Center, part of the American Electric Power Research Institute, has released an interactive manual with a VR interface for working with the Terry Turbine (figure 6). After wearing the connected VR helmet and running the program, the user enters the learning environment having four modes available [64]:

- 1) instruction – an animated video is launched, which shows the procedure for disassembly and assembly of the turbine line;
- 2) arbitrary – you can pull out and put back in place the nodes of the turbine in any order;
- 3) workshop – a user disassembles and assembles the unit with the help of prompts, the program alternately highlights the nodes;
- 4) test – only text instructions are available.

Besides, a pair of manual manipulators is used to control actions with a virtual turbocharger. Experts from the Electric Power Research Institute first tested the program. The energy company Dominion Energy received this simulator, tested it at three of its NPPs, and gave a high rating. A virtual simulator, which is more straightforward, cheaper, safer, and more interesting than the traditional one, should interest young people in working at nuclear power plants and improve personnel situation [64].

Using VR technologies for NPP construction, it is possible to control (support) the station's structure, perform staff training, present the construction project, and new equipment. For staff training, the VR complex includes a system of interactive interaction (tracking), which monitors



Figure 6: An example of the Terry Turbine simulator (<https://www.youtube.com/watch?v=cCdlrxKHvk4>).

the movement of a person dressed in a particular suit. Special VR-gloves allow users to work out the installation processes on virtual objects, check the level of assembly of structures, and the interchangeability of their parts [64].

Various specialized firms and organizations currently develop training equipment for nuclear power plants and other enterprises in the energy sector. One of them is NPP “Educational Technology” [74] (figure 7), which is a research and production enterprise with extensive experience in the development and production of components of modern high-tech educational environments for various sectors of industry. Educational equipment for nuclear energy, together with digital technologies, is designed to comprehensively support all forms of the educational process in the following specialties “Nuclear power plants: design, operation and engineering”, “Boilers, combustion chambers and steam generators”, “Nuclear energy and thermo-physics”. Atomic energy booths and their information support are designed following curricula, programs, and educational standards. The new generation of interactive educational equipment (emulators) at the expense of a virtual laboratory workshop provides practice-oriented training of nuclear specialists. Simulators, training stands, visual aids, emulators, layouts of conventional equipment and interactive multimedia equipment for the “Thermodynamics and heat transfer”, “Hydraulics”, “Chemistry”, “Power stations”, “Electrical engineering and basics of electronics”, etc. virtual laboratories were developed specifically to provide the educational process for the training of future specialists in nuclear energy [74].

The transition of nuclear energy to a higher technological paradigm prompted the creation of high-tech teaching aids in vocational education: simulators, emulators (NPP simulators), which are the most effective tools for forming professional competencies for the future NPP employees (figure 8). Such interactive teaching aids and visual aids allow for minimal material and resource costs to identify and consolidate students’ causal links in the studied objects, phenomena, and processes [74].

We believe that it is essential to apply an integrated approach in the training and professional development of NPP personnel, namely VR and AR technologies, into distance learning platforms. For students and employees of different NPPs to have the opportunity to plan their study

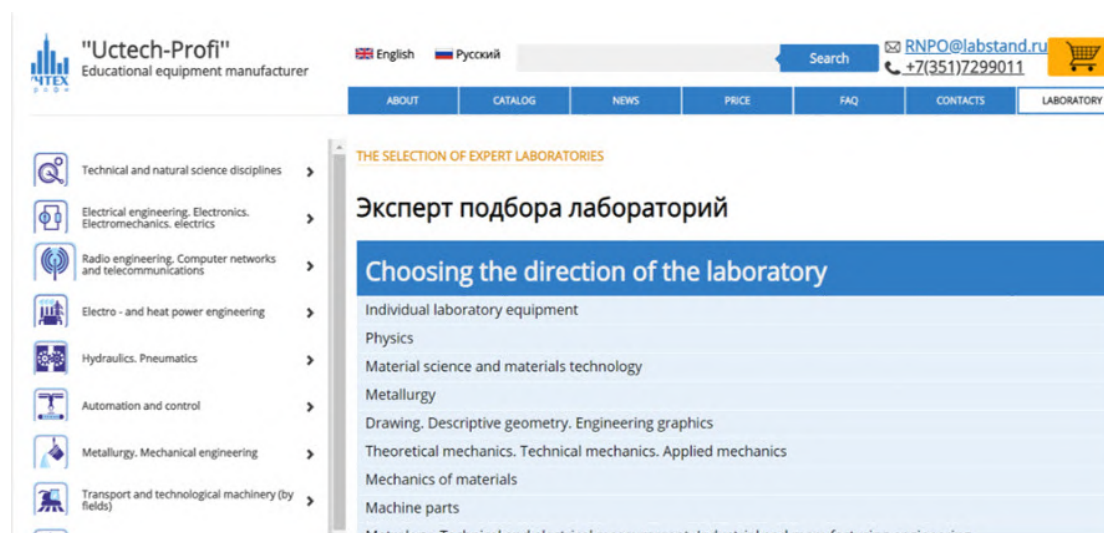

Figure 7: Materials on the site “Educational equipment”.

schedules, select the necessary sections, listen to lectures, and work with VR and AR technologies using various equipment.

2.5. Application of VR and AR technologies for the popularization of professions in the field of nuclear energy among children and youth

The nuclear energy sector is crucial for any developed country, as it is a supplier of electricity. Therefore, this industry needs new professionals and highly qualified specialists. There is a widespread stereotype that NPPs pose a significant threat to the population and the environment. Still, when you get acquainted in detail with the structure and principles of NPPs, it turns out that the routine operation of NPPs in comparison with other energy companies (CHP, TPP, HPP, etc.) have the least impact on the environment. This stereotype is why young people do not want to get an education in power engineering and nuclear power plants. Another reason is that today (in Ukraine) the current curricula “Physics 7-9th grades”, and “Physics and astronomy for 10-11th grades” provide for the study of topics: “Physical foundations of nuclear energy” (section “Physics of the atomic and atomic nucleus”, 9th grade); “Nuclear Energy” (section “Quantum Physics”, 11th grade); “Energy” (section “Technology” of the Integrated Course, 11th grade). These sections discuss the advantages and disadvantages of using nuclear energy, the development of Ukraine’s nuclear energy, ways to ensure the safety of nuclear reactors and nuclear power plants, the Chernobyl problem, the effects of atomic energy on the environment, protection from radiation, etc.

Researching the topic of Nuclear Energy, students should master the knowledge component, i.e., to know the principle of operation of a nuclear reactor, the effects of radioactive radiation on living organisms. They suppose to master the activity component to explain the ionizing impact of radioactive radiation, use a dosage meter, if available; as well as to use the acquired



Figure 8: NPP virtual laboratory [74].

knowledge for life safety); the value component to realize the advantages, disadvantages, and prospects of nuclear energy, the possibility of using fusion, assess the feasibility of its use and nuclear on ecology, the efficiency of methods of protection against the influence of radioactive radiation. We believe that it is necessary to partially acquaint students with the topic of “Nuclear Energy” to expand children’s general outlook about nuclear power plants’ operation in grades 5-7 and carry out a wide range of career guidance activities. As NPPs are closed to a wide range of people, mostly schoolchildren, it is possible to use VR and AR technologies, which will help better understand the various physicochemical processes occurring at NPPs.

Play-based learning of students using VR and AR technologies motivates them to perform certain operations for a long time, receiving specific incentives (for example, to collect trophies or receive particular points). Learning through play, especially serious games that have in-depth content, quickly fascinate students. Games also promote the development of various skills and qualities, require players to solve multiple complex problems and require specific knowledge on a particular topic. Some – simply require general critical thinking. A variety of video games or simulators can currently teach students to study nuclear energy topics. Students can get

acquainted with various aspects of NPP operation in an interactive form. We will describe some video games about the operation of nuclear power plants and other information resources:

1. **Nuclear Power Plant Simulator for Windows PCs** (<http://www.ae4rv.com/store>). In this game, you need to monitor the devices, troubleshoot, and monitor staff.

2. **Nuclear inc 2** (<https://play.google.com>) can be played on a smartphone (figure 9). Advanced functionality has been added to this NPP simulator, making it more challenging to operate a nuclear reactor. The player becomes a real engineer of famous atomic power plants, including the Chernobyl Nuclear Power Plant and Fukushima Daiichi Nuclear Power Plant. Unforeseen situations occur during the game – such as an earthquake, releases of radioactive substances, and fire. The player must monitor generators' temperatures, nuclear reactors, turbines, pressure levels, and the possibility of radiation. Besides, players are trained and told how different processes occur in the simulator and how people get electricity. Twelve levels of difficulty are available. In the first levels, the player monitors a small number of indicators. The next steps are complicated.

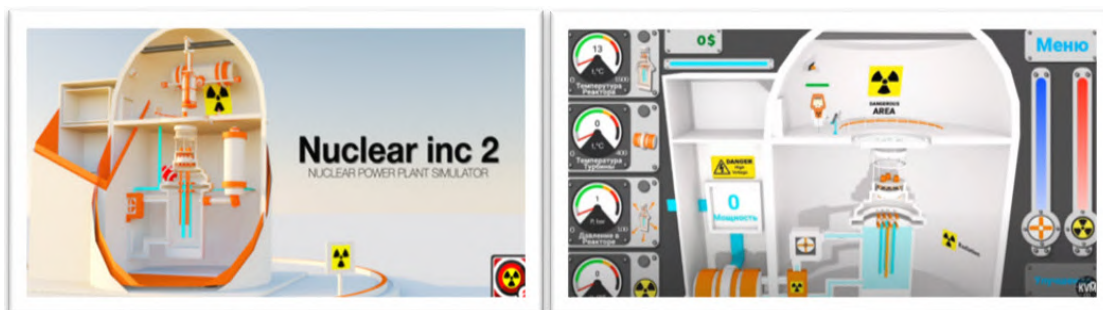

Figure 9: Nuclear inc 2.

3. **NPP before your eyes** (<https://play.google.com>) (figure 10). The game tells about radiation in nature and various areas of modern radiation technologies: medicine and agriculture. The game reveals interesting facts about nuclear energy and alternative energy sources. While playing it, you can learn about the specifics of building a nuclear power plant and test its strength with an intense hurricane. The application is adapted for students and audiences who do not have special education.

4. **Roblox Hyptek Nuclear Power Plant** (<https://www.roblox.com>). This game is a simulator of a nuclear reactor.

5. **Nuclear Power Station Creator** (<https://store.steampowered.com>) (figure 11). The game takes place in Japan to learn from your own experience of how nuclear power plants work. The player can operate the entire national network of NPPs and maintain its operation, monitor safety, and implement new technologies. As cities grow, their electricity needs increase, so nuclear power plants' requirements are continually improving. The player's task is to become a national leader in nuclear energy to prevent bankruptcy and decrease confidence in this industry.

6. **NPP simulator** on the site [74]. This resource contains various simulators designed to study the structure and principles of NPP operation.



Figure 10: “NPP before your eyes” game.

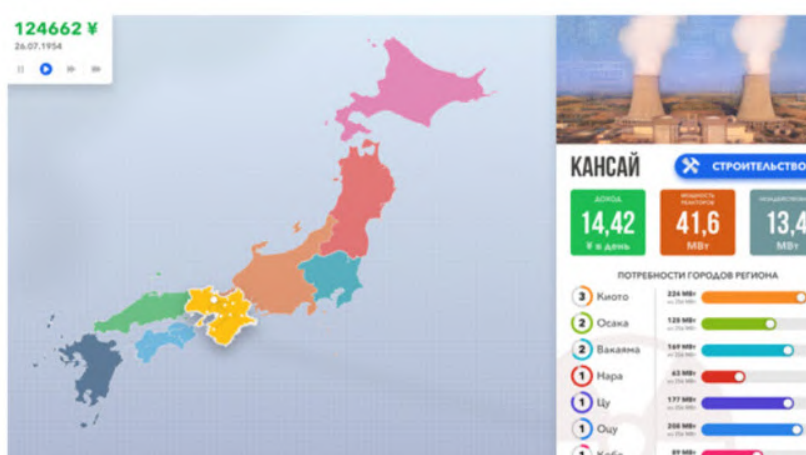

Figure 11: “Nuclear Power Station Creator” game.

7. Various **interactive quizzes and career guidance games** (figure 12) in the field of nuclear energy are posted on the website of the Information Center of the Atomic Industry [75].

Thus, the use of VR and AR technologies for play-based learning for children and youth in nuclear energy will increase interest in educational material through interactive content. It will speed up the formation of various skills and mastering knowledge, increase motivation for independent educational and cognitive activities by introducing the game, and competitive incentives. It will also intensify educational activities and help form a positive attitude to the nuclear energy industry, develop personal qualities (creativity, teamwork, etc.), increase the atomic energy professions’ prestige, and more.



Figure 12: NPP Construction Game.

3. Conclusions

The VR and AR technologies rapid development has expanded the scope of their application and has led to the need for various studies and experiments on their application and effectiveness. In this publication, the authors carried out an analysis of the VR and AR technologies peculiarities for the training and retraining of NPP personnel was carried out and considered the following aspects:

1. *Application of VR and AR technologies for educational purposes.* Educational institutions apply VR and AR technologies for educational purposes. However, they do it mainly for the training of technical specialties. The research is being actively conducted on VR and AR training for specialists' exercise in multiple areas. In a few years, experimental data and results of such investigations will be available.
2. *VR and AR technologies application examples and trends in various industries.* Examples and directions of application of VR and AR technologies for different industries. Analyzing the international experience of using these technologies, we note that powerful companies and large companies have long used VR and AR in the sectors they operate.
3. *VR and AR technologies application examples and trends for NPPs.* The economic efficiency of using VR and AR for NPPs is achieved by eliminating design errors before the start of the construction phase, reducing time and costs for business trips of staff for staff professional development, increasing the level of industrial safety, and increasing management efficiency. Thus, VR and AR technologies for nuclear energy are successfully used in the following areas: modeling of various atomic energy processes, staff training,

and education; operation, repair, and maintenance of NPP equipment; presentation of activities, NPP construction.

4. *Peculiarities of application of VR and AR technologies for training of future specialists and advanced training of NPP personnel.* The highest requirements are set for NPP personnel training, as these stations are objects of critical infrastructure and must operate reliably and safely. The use of VR and AR technologies allows organizing staff training and carrying out advanced training in conditions close to real, safe for participants and equipment. VR and AR technologies are useful for working out the order of actions in the emergency mode; to optimize the temporary cost of urgent repairs; to work out dismantling/installation of equipment elements; to identify weaknesses in the work of individual pieces of equipment and the working complex as a whole. Besides, with the help of VR and AR, you can visualize the project for collective acquaintance, further adjustment, and joint decision-making in the framework of corporate activities. Therefore, it is essential to prepare training materials and develop using VR and AR technologies of various simulators and virtual laboratories for the nuclear power industry based on the best world practices.
5. *Application of VR and AR technologies for the popularization of professions in nuclear energy among children and youth.* Due to VR and AR technologies, the issues of “nuclear energy safety” have gained new importance both for NPP personnel and for the training of future specialists in the field of nuclear energy. It becomes possible to inform about the functioning of the atomic industry and prospects for the development of atomic power, as well as to increase the prestige of industry professions and popularization of science and digital technologies applying VR and AR to acquaint children and young people with nuclear energy in an interactive form.

References

- [1] Cabinet of Ministers of Ukraine, Pro skhvalennya Enerhetychnoyi stratehiyi Ukrayiny na period do 2035 roku “Bezpeka, enerhoefektyvnist’, konkurentospromozhnist’ [On approval of the Energy Strategy of Ukraine for the period up to 2035 “Security, energy efficiency, competitiveness”], 2017. URL: <https://zakon.rada.gov.ua/laws/show/605-2017-%D1%80?lang=en>.
- [2] O. Popov, A. Iatsyshyn, V. Kovach, V. Artemchuk, D. Taraduda, V. Sobyna, D. Sokolov, M. Dement, T. Yatsyshyn, I. Matvieieva, Analysis of possible causes of npp emergencies to minimize risk of their occurrence, Nucl. Radiat. Saf. 81 (2019) 75–80. doi:10.32918/nrs.2019.1(81).13.
- [3] Y. Wu, Development and application of virtual nuclear power plant in digital society environment, International Journal of Energy Research 43 (2019) 1521–1533. URL: <https://onlinelibrary.wiley.com/doi/abs/10.1002/er.4378>. doi:10.1002/er.4378.
- [4] N. V. Morze, O. V. Strutynska, Digital transformation in society: key aspects for model development, Journal of Physics: Conference Series 1946 (2021) 012021. doi:10.1088/1742-6596/1946/1/012021.
- [5] Cabinet of Ministers of Ukraine, Pro skhvalennia Kontseptsii rozvytku tsyfrovoy ekonomiky

- ta suspilstva Ukrainy na 2018-2020 roky ta zatverdzhennia planu zakhodiv shchodo yii realizatsii [On approval of the Concept of the development of the digital economy and society of Ukraine for 2018-2020], 2018. URL: <https://zakon.rada.gov.ua/laws/show/605-2017-%D1%80?lang=en>.
- [6] Virtual'naya real'nost' v promyshlennoy avtomatizatsii [Virtual reality in industrial automation], 2020. URL: <http://ua.automation.com/content/virtualnaja-realnost-v-promyshlennoj-avtomatizacii>.
- [7] V. Gurieiev, O. Sanginova, Simulation and study of modes for full-scale mode simulator for ukrainian energy systems, in: 2016 2nd International Conference on Intelligent Energy and Power Systems (IEPS), 2016, pp. 1–4. doi:10.1109/IEPS.2016.7521848.
- [8] V. Gurieiev, O. Sanginova, Distributed simulation environment of modes for full-scale mode simulator for Ukrainian energy systems, *Tekhnichna elektrodynamika* 5 (2016) 67–69. doi:10.15407/techned2016.05.067.
- [9] Y. Parus, I. Blinov, Imitation modeling of the balancing electricity market functioning taking into account system constraints on the parameters of the IPS of Ukraine mode, *Tekhnichna elektrodynamika* 6 (2017) 72–79. doi:10.15407/publishing2019.53.028.
- [10] O. Kyrylenko, I. Blinov, Y. Parus, H. Ivanov, Simulation model of day ahead market with implicit consideration of power systems network constraints, *Tekhnichna elektrodynamika* 5 (2019) 60–67. doi:10.15407/techned2019.05.060.
- [11] A. Zaporozhets, V. Eremenko, R. Serhiienko, S. Ivanov, Methods and hardware for diagnosing thermal power equipment based on smart grid technology, in: N. Shakhovska, M. O. Medykovskyy (Eds.), *Advances in Intelligent Systems and Computing III*, Springer International Publishing, Cham, 2019, pp. 476–489.
- [12] C. Chauliac, J.-M. Aragonés, D. Bestion, D. G. Cacuci, N. Crouzet, F.-P. Weiss, M. A. Zimmermann, Nuresim – a european simulation platform for nuclear reactor safety: Multi-scale and multi-physics calculations, sensitivity and uncertainty analysis, *Nuclear Engineering and Design* 241 (2011) 3416–3426. doi:10.1016/j.nucengdes.2010.09.040, seventh European Commission conference on Euratom research and training in reactor systems (Fission Safety 2009).
- [13] T. Masood, J. Egger, Adopting augmented reality in the age of industrial digitalisation, *Computers in Industry* 115 (2020) 103112. doi:10.1016/j.compind.2019.07.002.
- [14] G. Fauville, A. C. M. Queiroz, J. N. Bailenson, Chapter 5 - Virtual reality as a promising tool to promote climate change awareness, in: J. Kim, H. Song (Eds.), *Technology and Health*, Academic Press, 2020, pp. 91–108. doi:10.1016/B978-0-12-816958-2.00005-8.
- [15] M. Unal, E. Bostanci, E. Sertalp, Distant augmented reality: Bringing a new dimension to user experience using drones, *Digital Applications in Archaeology and Cultural Heritage* 17 (2020) e00140. doi:10.1016/j.daach.2020.e00140.
- [16] S. Qin, Q. Wang, X. Chen, Application of virtual reality technology in nuclear device design and research, *Fusion Engineering and Design* 161 (2020) 111906. doi:10.1016/j.fusengdes.2020.111906.
- [17] L. Gabcan, A. Alves, P. Frutuoso e Melo, 3D simulation model of water infiltration for radioactive waste on a virtual reality Environment: An application to the Abadia de Goiás repository, *Annals of Nuclear Energy* 140 (2020) 107265. doi:10.1016/j.anucene.2019.107265.

- [18] S. Alizadehsalehi, A. Hadavi, J. C. Huang, From BIM to extended reality in AEC industry, *Automation in Construction* 116 (2020) 103254. doi:10.1016/j.autcon.2020.103254.
- [19] A. Zaporozhets, S. Kovtun, O. Dekusha, System for Monitoring the Technical State of Heating Networks Based on UAVs, in: N. Shakhovska, M. O. Medykovskyy (Eds.), *Advances in Intelligent Systems and Computing IV*, Springer International Publishing, Cham, 2020, pp. 935–950.
- [20] O. Popov, A. Iatsyshyn, V. Kovach, V. Artemchuk, D. Taraduda, V. Sobyna, D. Sokolov, M. Dement, V. Hurkovskyy, K. Nikolaiev, T. Yatsyshyn, D. Dimitriieva, Physical features of pollutants spread in the air during the emergency at NPPs, *Nucl. Radiat. Saf.* 84 (2019) 88–98. doi:10.32918/nrs.2019.4(84).11.
- [21] O. Popov, A. Iatsyshyn, V. Kovach, V. Artemchuk, I. Kameneva, D. Taraduda, V. Sobyna, D. Sokolov, M. Dement, T. Yatsyshyn, Risk assessment for the population of Kyiv, Ukraine as a result of atmospheric air pollution, *J. Health Pollut.* 10 (2020) 200303. doi:10.5696/2156-9614-10.25.200303.
- [22] A. Iatsyshyn, A. Iatsyshyn, V. Artemchuk, I. Kameneva, V. Kovach, O. Popov, Software tools for tasks of sustainable development of environmental problems: peculiarities of programming and implementation in the specialists' preparation, *E3S Web of Conferences* 166 (2020) 01001. doi:10.1051/e3sconf/202016601001.
- [23] V. Mokhor, S. Gonchar, O. Dybach, Methods for the total risk assessment of cybersecurity of critical infrastructure facilities, *Nucl. Radiat. Saf.* 82 (2019) 4–8. doi:10.32918/nrs.2019.2(82).01.
- [24] Y. Kyrylenko, I. Kameneva, O. Popov, A. Iatsyshyn, V. Artemchuk, V. Kovach, Source Term Modelling for Event with Liquid Radioactive Materials Spill, Springer International Publishing, Cham, 2020, pp. 261–279. doi:10.1007/978-3-030-48583-2_17.
- [25] V. Burtniak, Y. Zabulonov, M. Stokolos, L. Bulavin, V. Krasnoholovets, The remote radiation monitoring of highly radioactive sports in the Chernobyl exclusion zone, *Journal of Intelligent & Robotic Systems* 90 (2018) 437–442. doi:10.1007/s10846-017-0682-7.
- [26] Y. Zabulonov, V. Burtniak, L. Odukalets, System for effective remote control and monitoring of radiation situation based on unmanned aerial vehicle, *Science and Innovation* 13 (2017) 40–45. doi:10.15407/scine13.04.040.
- [27] O. Popov, A. Iatsyshyn, V. Kovach, V. Artemchuk, D. Taraduda, V. Sobyna, D. Sokolov, M. Dement, T. Yatsyshyn, Conceptual approaches for development of informational and analytical expert system for assessing the NPP impact on the environment, *Nucl. Radiat. Saf.* 79 (2018) 56–65. doi:10.32918/nrs.2018.3(79).09.
- [28] O. Syrovatskyi, S. Semerikov, Y. Modlo, Y. Yechkalo, S. Zelinska, Augmented reality software design for educational purposes, *CEUR Workshop Proceedings* 2292 (2018) 193–225. URL: <http://ceur-ws.org/Vol-2292/paper20.pdf>.
- [29] M. Popel, M. Shyshkina, The cloud technologies and augmented reality: The prospects of use, *CEUR Workshop Proceedings* 2257 (2018) 232–236. URL: <http://ceur-ws.org/Vol-2257/paper23.pdf>.
- [30] F. Arici, P. Yildirim, Şeyma Caliklar, R. M. Yilmaz, Research trends in the use of augmented reality in science education: Content and bibliometric mapping analysis, *Computers & Education* 142 (2019) 103647. doi:10.1016/j.compedu.2019.103647.
- [31] D. Sahin, R. M. Yilmaz, The effect of Augmented Reality Technology on middle school

- students' achievements and attitudes towards science education, *Computers & Education* 144 (2020) 103710. doi:10.1016/j.compedu.2019.103710.
- [32] D. Scaravetti, D. Doroszewski, Augmented Reality experiment in higher education, for complex system appropriation in mechanical design, *Procedia CIRP* 84 (2019) 197–202. doi:10.1016/j.procir.2019.04.284, 29th CIRP Design Conference 2019, 08-10 May 2019, Póvoa de Varzim, Portugal.
- [33] J. Garzón, J. Acevedo, Meta-analysis of the impact of augmented reality on students' learning gains, *Educational Research Review* 27 (2019) 244–260. doi:10.1016/j.edurev.2019.04.001.
- [34] M. Alahmari, T. Issa, T. Issa, S. Z. Nau, Faculty awareness of the economic and environmental benefits of augmented reality for sustainability in Saudi Arabian universities, *Journal of Cleaner Production* 226 (2019) 259–269. doi:10.1016/j.jclepro.2019.04.090.
- [35] M.-B. Ibáñez, C. Delgado-Kloos, Augmented reality for STEM learning: A systematic review, *Computers & Education* 123 (2018) 109–123. doi:10.1016/j.compedu.2018.05.002.
- [36] S. R. Sorko, M. Brunnhofer, Potentials of augmented reality in training, *Procedia Manufacturing* 31 (2019) 85–90. doi:10.1016/j.promfg.2019.03.014, research. Experience. Education. 9th Conference on Learning Factories 2019 (CLF 2019), Braunschweig, Germany.
- [37] M. Quandt, B. Knoke, C. Gorltdt, M. Freitag, K.-D. Thoben, General requirements for industrial augmented reality applications, *Procedia CIRP* 72 (2018) 1130–1135. doi:10.1016/j.procir.2018.03.061, 51st CIRP Conference on Manufacturing Systems.
- [38] P. Milgram, F. Kishino, A taxonomy of mixed reality visual displays, *IEICE Transactionson Information Systems E77-D(12)* (1994) 1321–1329.
- [39] E. Orlova, I. Karpova, Ispol'zovanie tehnologij dopolnennoj i virtual'noj real'nosti v prepodavanii v tehničeskom vuze [Using augmented and virtual reality technologies in teaching at a technical university], *Metodicheskie voprosy prepodavanija infokommunikacij v vysshej shkole* 7 (2018) 40–43.
- [40] J. Kahtanova, K. Bestybaeva, Tehnologija dopolnennoj real'nosti v obrazovanii [Technology of augmented reality in education], *Pedagogičeskoe masterstvo i pedagogičeskie tehnologii* 28 (2016) 289–291.
- [41] K. Leshko, L. Rykova, Augmented reality as a tool in creative development of future education professionals, *New Computer Technology* 17 (2019) 76–81.
- [42] R. Butov, I. Grigor'ev, Tehnologii virtual'noj i dopolnennoj real'nosti dlja obrazovanija [Virtual and augmented reality technologies for education], *Pro-DOD* 1 (2018) 18–29. URL: <http://prodod.moscow/archives/6428>.
- [43] S. Pochtoviuk, T. Vakaliuk, A. Pikilnyak, Possibilities of application of augmented reality in different branches of education, *CEUR Workshop Proceedings* 2547 (2020) 92–106. URL: <http://www.ceur-ws.org/Vol-2547/paper07.pdf>.
- [44] A. Iatsyshyn, V. Kovach, V. Lyubchak, Y. Zuban, A. Piven, O. Sokolyuk, A. Iatsyshyn, O. Popov, V. Artemchuk, M. Shyshkina, Application of augmented reality technologies for education projects preparation, *CEUR Workshop Proceedings* 2643 (2020) 134–160. URL: <http://ceur-ws.org/Vol-2643/paper07.pdf>.
- [45] A. Iatsyshyn, V. Kovach, Y. Romanenko, I. Deinega, A. Iatsyshyn, O. Popov, Y. Kutsan, V. Artemchuk, O. Burov, S. Lytvynova, Application of augmented reality technologies for preparation of specialists of new technological era, *CEUR Workshop Proceedings* 2547

- (2020) 181–200. URL: <http://ceur-ws.org/Vol-2547/paper14.pdf>.
- [46] Y. Kutsan, V. Gurieiev, A. Iatsyshyn, A. Iatsyshyn, E. Lysenko, Development of a Virtual Scientific and Educational Center for Personnel Advanced Training in the Energy Sector of Ukraine, Springer International Publishing, Cham, 2020, pp. 69–84. doi:10.1007/978-3-030-48583-2_5.
- [47] S. C.-Y. Yuen, G. Yaoyuneyong, E. Johnson, Augmented reality: An overview and five directions for AR in education, *Journal of Educational Technology Development and Exchange* 4 (2011) 119–140. doi:10.18785/jetde.0401.10.
- [48] T. Hruntova, Y. Yechkalo, A. Striuk, A. Pikilnyak, Augmented reality tools in physics training at higher technical educational institutions, *CEUR Workshop Proceedings 2257* (2018) 33–40. URL: <http://ceur-ws.org/Vol-2257/paper04.pdf>.
- [49] C. Uriel, S. Sergio, G. Carolina, G. Mariano, D. Paola, A. Martín, Improving the understanding of basic sciences concepts by using virtual and augmented reality, *Procedia Computer Science* 172 (2020) 389–392. doi:10.1016/j.procs.2020.05.165, 9th World Engineering Education Forum (WEEF 2019) Proceedings : Disruptive Engineering Education for Sustainable Development.
- [50] O. Lavrentieva, I. Arkhypov, O. Kuchma, A. Uchitel, Use of simulators together with virtual and augmented reality in the system of welders’ vocational training: Past, present, and future, *CEUR Workshop Proceedings 2547* (2020) 201–216.
- [51] A. Striuk, M. Rassovytska, S. Shokaliuk, Using Blippar augmented reality browser in the practical training of mechanical engineers, *CEUR Workshop Proceedings 2104* (2018) 412–419.
- [52] P. Nechypurenko, T. Starova, T. Selivanova, A. Tomilina, A. Uchitel, Use of augmented reality in chemistry education, *CEUR Workshop Proceedings 2257* (2018) 15–23.
- [53] S. Zelinska, A. Azaryan, V. Azaryan, Investigation of opportunities of the practical application of the augmented reality technologies in the information and educative environment for mining engineers training in the higher education establishment, *CEUR Workshop Proceedings 2257* (2018) 204–214.
- [54] N. Rashevskaya, V. Soloviev, Augmented reality and the prospects for applying its in the training of future engineers, *CEUR Workshop Proceedings 2257* (2018) 192–197.
- [55] T. Kramarenko, O. Pylypenko, V. Zaselskiy, Prospects of using the augmented reality application in STEM-based Mathematics teaching, *CEUR Workshop Proceedings 2547* (2020) 130–144.
- [56] N. Zinonos, E. Vihrova, A. Pikilnyak, Prospects of using the augmented reality for training foreign students at the preparatory departments of universities in Ukraine, *CEUR Workshop Proceedings 2257* (2018) 87–92.
- [57] Y. Modlo, S. Semerikov, S. Bondarevskiy, S. Tolmachev, O. Markova, P. Nechypurenko, Methods of using mobile Internet devices in the formation of the general scientific component of bachelor in electromechanics competency in modeling of technical objects, *CEUR Workshop Proceedings 2547* (2020) 217–240.
- [58] V. Tkachuk, Y. Yechkalo, S. Semerikov, M. Kislova, Y. Hladyr, Using Mobile ICT for Online Learning During COVID-19 Lockdown, in: A. Bollin, V. Ermolayev, H. C. Mayr, M. Nikitchenko, A. Spivakovskiy, M. Tkachuk, V. Yakovyna, G. Zholtkevych (Eds.), *Information and Communication Technologies in Education, Research, and Industrial Applications*,

- Springer International Publishing, Cham, 2021, pp. 46–67.
- [59] S. O. Semerikov, M. M. Mintii, I. S. Mintii, Review of the course “Development of Virtual and Augmented Reality Software” for STEM teachers: implementation results and improvement potentials, CEUR Workshop Proceedings (2021).
 - [60] T. A. Vakaliuk, S. I. Pochtoviuk, Analysis of tools for the development of augmented reality technologies, CEUR Workshop Proceedings (2021).
 - [61] V. V. Babkin, V. V. Sharavara, V. V. Sharavara, V. V. Bilous, A. V. Voznyak, S. Y. Kharchenko, Using augmented reality in university education for future IT specialists: educational process and student research work, CEUR Workshop Proceedings (2021).
 - [62] O. Lavrentieva, I. Arkhypov, O. Krupskiy, D. Velykodnyi, S. Filatov, Methodology of using mobile apps with augmented reality in students’ vocational preparation process for transport industry, CEUR Workshop Proceedings 2731 (2020) 143–162.
 - [63] Kitayskiye uchonyye razrabotali VR-simulyator atomnoy elektrostantsii [Chinese scientists have developed a VR simulator of a nuclear power plant], 2019. URL: <https://holographica.space/news/virtual4ds-20583>.
 - [64] Kak VR-tehnologiyu ispol’zuyut v energetike [How VR technology is used in energy], 2019. URL: <https://cutt.ly/KgpPPOy>.
 - [65] Tekhnologii virtual’noy i dopolnennoy real’nosti nakhodyat primeneniye v energetike [Virtual and augmented reality technologies find application in energy], 2019. URL: <https://gisprofi.com/gd/documents/tehnologii-virtualnoj-i-dopolnennoj-realnosti-nahodyat-primenenie-v.html>.
 - [66] Virtual’no-tsifrovaya AES prinyata v ekspluatatsiyu [Virtual digital nuclear power plant accepted for operation], 2020. URL: <https://energybase.ru/news/companies/virtual-digital-nuclear-power-plant-accepted-for-operation-2020-02-26>.
 - [67] Tekhnologiya ”Virtual’naya AES” - unikal’naya razrabotka rossiyskikh uchenykh, pozvolyayushchaya yeshche do puska energobloka proverit’ tekhnicheskiye resheniya i obosnovat’ bezopasnost’ proyekta ”AES-2006” [The ”Virtual NPP” technology is a unique development of Russian scientists, which allows checking technical solutions and justifying the safety of the ”NPP-2006”], 2014. URL: <https://www.sb.by/articles/energetika-budushchego-22.html>.
 - [68] Virtual’naya AES - tekhnologiya bezopasnosti [Virtual NPP - safety technology], 2014. URL: https://atom.belta.by/ru/analytics_ru/view/analytics_ru/view/virtualnaja-aes-texnologija-bezopasnosti-3824/t_id/1/.
 - [69] STEPS, Digital Twin: the Challenge of Nuclear Power Plants, 2017. URL: <https://www.corys.com/en/steps/article/digital-twin-challenge-nuclear-power-plants>.
 - [70] POWER, Advanced Nuclear Reactor Designs to Get Digital Twins, 2020. URL: <https://www.powermag.com/advanced-nuclear-reactor-designs-to-get-digital-twins>.
 - [71] STEPS, Digital reactor project: the practical stage, 2020. URL: <https://www.corys.com/en/steps/article/digital-reactor-project-practical-stage>.
 - [72] O. Popov, A. Iatsyshyn, D. Sokolov, M. Dement, I. Neklonskyi, A. Yelizarov, Application of Virtual and Augmented Reality at Nuclear Power Plants, Springer International Publishing, Cham, 2021, pp. 243–260. doi:10.1007/978-3-030-69189-9_14.
 - [73] Trimetari Consulting, Sozdaniye interaktivnykh 3D-prilozheniy i sistem virtual’noy real’nosti [Creation of interactive 3D applications

- and virtual reality systems], 2020. URL: <http://trimetari.com/ru/uslugi/sozdanie-interaktivnyh-3d-prilozhenij-i-sistem-virtualnoj-realnosti>.
- [74] LLC NPP "Uchteh-Profi", Virtual'nyye stendy po atomnoy energetike [Nuclear energy virtual stands], 2020. URL: http://labstand.ru/catalog/atomnaya_energetika.
- [75] Informatsionnyy Tsentr Atomnoy Otrastli [Nuclear Industry Information Center], 2020. URL: <https://myatom.ru/>.

Using augmented reality in university education for future IT specialists: educational process and student research work

Vladyslav V. Babkin¹, Viktor V. Sharavara¹, Volodymyr V. Sharavara¹,
Vladyslav V. Bilous², Andrei V. Voznyak³ and Serhiy Ya. Kharchenko⁴

¹Alfred Nobel University, 18 Sichslavska Naberezhna, Dnipro, 49000, Ukraine

²Borys Grinchenko Kyiv University, 18/2, Bulvarno-Kudriavska Str., Kyiv, 04053, Ukraine

³Kryvyi Rih State Pedagogical University, 54 Gagarin Ave., Kryvyi Rih, 50086, Ukraine

⁴Luhansk Taras Shevchenko National University, 1 Gogol Sq., Starobilsk, 92703, Ukraine

Abstract

The article substantiates the feature of using augmented reality (AR) in university training of future IT specialists in the learning process and in the research work of students. The survey of university teachers analyzed the most popular AR applications for training future IT specialists (AR Ruler, AR Physics, Nicola Tesla, Arloon Geometry, AR Geometry, GeoGebra 3D Graphing Calculator, etc.), disclose the main advantages of the applications. The methodological basis for the implementation of future IT specialists research activities towards the development and use of AR applications is substantiated. The content of the activities of the student's scientific club "Informatics studios" of Borys Grinchenko Kyiv University is developed. Students as part of the scientific club activity updated the mobile application, and the model bank corresponding to the topics: "Polyhedrons" for 11th grade, as well as "Functions, their properties and graphs" for 10th grade. The expediency of using software tools to develop a mobile application (Android Studio, SDK, NDK, QR Generator, FTDS Dev, Google Sceneform, Poly) is substantiated. The content of the stages of development of a mobile application is presented. As a result of a survey of students and pupils the positive impact of AR on the learning process is established.

Keywords

augmented reality, mobile application, university training of students, IT specialists

AREdu 2021: 4th International Workshop on Augmented Reality in Education, May 11, 2021, Kryvyi Rih, Ukraine

✉ vladiksonic@gmail.com (V. V. Babkin); victor.sharavara@gmail.com (V. V. Sharavara);

vovasharavara@gmail.com (V. V. Sharavara); v.bilous@kubg.edu.ua (V. V. Bilous); avvoznyak76@gmail.com

(A. V. Voznyak); hk.sergey2014@ukr.net (S. Ya. Kharchenko); (S. Ya. Kharchenko)

🌐 https://duan.edu.ua/science-ukr/rada-molodykh-vchenykh.html#babkin_v (V. V. Babkin);

https://duan.edu.ua/science-ukr/rada-molodykh-vchenykh.html#sharavara_v (V. V. Sharavara);

<http://eportfolio.kubg.edu.ua/teacher/1308> (V. V. Bilous); <https://kdpu.edu.ua/personal/avvoznyak.html>

(A. V. Voznyak); <http://irbis-nbu.gov.ua/ASUA/1260520> (S. Ya. Kharchenko)

🆔 0000-0003-0912-3237 (V. V. Babkin); 0000-0001-6777-6581 (V. V. Sharavara); 0000-0002-4551-262X

(V. V. Sharavara); 0000-0001-6915-433X (V. V. Bilous); 0000-0003-4683-1136 (A. V. Voznyak); 0000-0002-0310-6287

(S. Ya. Kharchenko)



© 2021 Copyright for this paper by its authors.
Use permitted under Creative Commons License Attribution 4.0 International (CC BY 4.0).

CEUR Workshop Proceedings (CEUR-WS.org)

1. Introduction

The introduction of modern virtual learning tools into the university training of students is the most important condition for enhancing the learning effect, which lies in the interactivity of 3D modeling and using the effect of augmented reality. Having a set of paper markers, it is possible to represent a learning object not only in volume, but also to do a number of manipulations with it, to look at it from different angles. The use of augmented reality is an important condition for the implementation of the modern educational process for students of any specialty. But AR becomes especially important for future IT specialists, who have not only to use, but also to develop AR tools in future professional activities. The relevance of implementing augmented reality technology in the educational process lies in the fact that the use of this innovative teaching tool increases students' motivation, increases the level of information assimilation by synthesizing different forms of its presentation [1].

The use of AR seems to be especially significant in distance learning conditions, which is confirmed by numerous feedback from university teachers during the year 2020 [2, 3, 4, 5, 6]. According to researches [7, 8, 9, 10, 11, 12, 13, 14, 15, 16, 17, 18, 19, 20, 21, 22, 23], the advantages of AR are visualization, information completeness, interactivity, which allows to develop students' imaginative thinking and spatial imagination, maintain interest in the learning process. At the same time, there are still insufficiently developed methods for building the learning process using AR, which opens the way to further scientific research.

Theoretical and practical aspects of using AR in the educational process are covered in numerous studies. Akçayır and Akçayır [24] submitted advantages and challenges associated with augmented reality for education. In particular, it has been established that the most reported advantage of AR is that it promotes enhanced learning achievement. Some noted challenges imposed by AR are usability issues and frequent technical problems. We found several other challenges and numerous advantages of AR usage, which are discussed in detail. In addition, current gaps in AR research and needs in the field are identified, and suggestions are offered for future research. Martín-Gutiérrez et al. [25] disclose virtual technologies trends in education. Among them are the following: educational institutions will benefit from better accessibility to virtual technologies; this will make it possible to teach in virtual environments that are impossible to visualize in physical classrooms, like accessing into virtual laboratories, visualizing machines, industrial plants, or even medical scenarios. The huge possibilities of accessible virtual technologies will make it possible to break the boundaries of formal education. Ibáñez and Delgado-Kloos [26] presented a systematic review of the literature on the use of augmented reality technology to support science, technology, engineering and mathematics (STEM) learning.

We consider the perspectives of AR methodological research to be interesting, as researchers need to design features that allow students to acquire basic competences related with STEM disciplines, and future applications need to include metacognitive scaffolding and experimental support for inquiry-based learning activities. Finally, it would be useful to explore how augmented reality learning activities can be part of blended instructional strategies such as the flipped classroom. Syrovatskyi et al. [27] presented the software for the design of augmented reality tools for educational purposes is characterized and the technological requirements for the optional course "Development of virtual and augmented reality software" are defined .

The papers [28, 29, 30] present some theoretical and practical aspects of using augmented reality in the process of professional training of future IT specialists as well as future computer science teachers at the level of leading trends, approaches, principles, conditions, and technologies. Besides, our previous work proves that in the field of physical processes modeling, the Proteus physics lab serves as a popular example of augmented reality. Using Proteus environment allows to visualize the work of functional units of computational system on microlevel. This is especially important for programming resource-limited systems, such as microcontrollers in the process of training future IT professionals [31].

Noteworthy are scientific studies on the use of various aspects of AR in the process of learning mathematics, considering that it is the mathematical training that is basic to the training of future IT specialists: Sollervall and Milrad [32] – implementation of mobile learning in mathematics, Chang et al. [33] – the use of game techniques in teaching mathematics, Bhagat and Chang [34], Kramarenko et al. [35] – application of GeoGebra for teaching geometry, etc. It's worth noting that in many scientific papers the authors analyze the possibilities of both VR and AR for the educational process. We believe that such a comprehensive analysis makes sense, because many modern methods of teaching students combine these technologies.

The *aim of the study* is to reveal the possibilities of AR for the implementation of training and research work of future IT specialists in the university.

In the process of research methods were used: analysis of scientific and pedagogical literature on the selection of theoretical and methodological foundations for the use of augmented reality in the learning process at the university, development of the content of scientific student circle activity; study and synthesis of teaching experience on the use of AR in the educational process; pedagogical experiment to bring the effectiveness of the AR mobile application in the learning process, highlighting by teachers the most popular AR applications, their advantages; methods of mathematical statistics.

2. Results and discussion

Augmented reality is a relatively new technology, gaining popularity in the educational process primarily because of its accessibility and inexpensiveness. To see augmented reality, you need a computer webcam or mobile device camera (smartphone, tablet, AR glasses) and a special application that superimposes digital information (3D models, video, audio, texts) on the real world image from the camera and displays the result on the screen. Using AR you can “animate” almost any educational materials – illustrations in books, diagrams, maps, drawings, create educational projects, explaining the phenomena, the demonstration of which for various reasons is difficult to organize in the classroom (due to lack of equipment, the inability to show in real life, the danger to health, etc.). Different visualization tools are used for different smartphones, for example, for Android – sfb, mtl, obj, fbx fsa extensions, for iOS – sfb, mtl, obj. Today, the technology has four basic techniques:

1. Marker-based – binding to a given element.
2. Markerless – free positioning.
3. Location-based – reading markers and geopositioning.
4. Based on the layer overlay – selecting a model from the device to display [36].

Technologically, the introduction of augmented reality into the learning process is uncomplicated. For example, when pointing the cameras of mobile devices at various objects, corresponding text explanations, photos, video files or a complex of text information and video series appear on the screen. Learning applications with augmented reality are proposed to be built according to the following scheme:

- the use of special tags;
- reading tags by computer or mobile device;
- playback the layer with additional information on the screen.

Our own experience in using augmented reality in the professional training of students allows us to highlight requirements for the use of AR through a mobile device:

- AR mode should be able to be switched off, with the option to switch to normal mode, where any “blank” background or a static 3D scene replaces the environment, and the content is positioned so that it is more convenient to view from the device.
- The text should be displayed on a backing that provides a contrasting and easy-to-read output. Long text should be scrollable.
- The photo gallery should be displayed on a substrate that provides an easy-to-view output and have transition elements to the next/previous photo.
- The audio recording should play through the audio system of the device and visually display the playback control panel with the ability to pause/resume audio playback as well as navigate to an arbitrary recording location.
- The video should play back with sound (if any) on a backing that provides its easy-to-view output and have a playback control panel with the ability to pause/resume the video as well as navigate to an arbitrary recording location.
- The 3D scene is initially prepared by the performer for correct display in AR mode and may have its own individual controls depending on the scenario.

There are different directions of AR research. The first direction is associated with the study of virtual (VR) and augmented reality (AR) technologies as a trend in the information technology industry, the basics of creating applications. The second direction is the pedagogical design of learning tools based on virtual and augmented reality technologies. The third is the definition and experimental verification of organizational and pedagogical conditions and techniques for the effective use of AR in the educational process [36].

Today, augmented reality technology is still developing, but it already has a number of applications, including for education. In October, November 2020 we conducted a survey among teachers at the Boris Grinchenko Kyiv University, the Sumy State Pedagogical University named after A. S. Makarenko, the Alfred Nobel University (Dnipro) and the Pavlo Tychyna Uman State Pedagogical University. A total of 48 teachers were interviewed, they are from physics and mathematics and computer science disciplines and have experience using AR in the educational process. As a result of the survey, the most popular AR applications were highlighted, which allowed to present their main advantages for the educational process.

1. *AR Ruler*. One of the easiest ideas to use augmented reality technology is measurement. Using AR’s ability to determine where three-dimensional objects begin and end, you can

measure the distance and easily display it. However, we are not just talking about simple direct measurements - the AR Ruler (aka AR ruler) also measures angles, volume, area, perimeter, etc. AR Ruler is a useful enough application to get approximate measurements when they are needed. According to the teachers, the add-on is most often used in the lessons of Analytical Geometry, Projective Geometry, and Image Methods.

2. *AR Physics (CG)*. The educational complex gives you the opportunity to learn about physical processes and phenomena. It includes more than 50 visual experiments on 9 sections of general physics. The complex allows: to conduct visual 3D demonstrations of physical processes and phenomena without the use of regular laboratory equipment; to organize students' independent work, etc. In the opinion of teachers, the addition has the following advantages: high detail structure and properties of the studied objects; deep immersion of students in the environment of the experiments; the possibility of experiments without laboratory equipment; the possibility of dangerous experiments without risk to life and health; direct user interaction with the virtual objects by augmented reality.
3. *AR Physics*. This app has a game style and full interaction with the learner. In the app it is possible to add various elements, conduct experiments, and monitor real processes. The app is available in different languages with introductory text, voiceover and animated models. It is used in the study of general physics. The application makes it possible to implement inquiry-based learning, provides interaction between teachers and students.
4. *Nicola Tesla*. The app provides access to products with embedded interactive content that comes to life when viewed through a mobile device. Features of the Nikola Tesla AR app include: virtual simulations, including a demonstration of how electricity flows through a Tesla winding, etc. The program promotes a better understanding of the subject and develops imagination and abstract thinking.
5. *Arloon Geometry*. Augmented reality app for learning geometry. Available 3D models with formulas for calculations, unfolding of figures, textual theoretical information. The add-on allows you to calculate the density of shapes, the volume of bodies (cube, cylinder, sphere, pyramid, cone, etc.). The program gives a sense of reality and practical experience, visualizes complex relationships, and concretizes abstract concepts.
6. *AR Geometry*. App with the use of augmented reality technology to the geometry textbook for grades 10-11. Used in classes on methods of teaching mathematics.
7. *GeoGebra 3D Graphing Calculator*. The application allows you to solve mathematical problems in 3D, build graphs of 3D functions and surfaces, create geometric constructions (bodies, spheres) in 3D, find their sections, store and distribute the results. Use when organizing classes in algebra, mathematical analysis, and analytic geometry.
8. *AR applications for elementary mathematics (AR MATH, Math Worlds AR, Math-O-Matic AR, Math Jumps: Math Games, Math Wiki - Learn Math)* for use in mathematics teaching methods classes.

There are still a significant number of well-known applications: *ModumLab*, *PhysicsPlayground*, *Algorithms: comprehensible and animated*, etc. At the same time, they were not recalled by the experts, opens the possibility of systematization and classification of available AR applications for use in the process of professional training of students.

As a result of the survey of respondents, we highlight the advantages of using AR in the educational process. These advantages are basic in the implementation of professional training of future IT specialists:

1. **Better explanation of complex and abstract concepts.** Practice shows that students understand theoretical concepts better when they can visualize them. This is especially true for complex topics with the use of visual three-dimensional models.
2. **Increased student engagement.** AR provides a playful approach to learning, which makes the class more emotional than a traditional class.
3. **No additional tools are required,** as most modern students have smartphones.
4. **Practice-oriented classes.** Students can perform practical exercises without the need for laboratory equipment.
5. **Accessible learning.** With AR applications, users can learn anytime and anywhere, which is important in a distance learning environment.

In our previous work [36] we solved the problem – the development of an AR application in mathematics in the process of research activities of the students of the specialty “Computer Science” of the Borys Grinchenko Kyiv University. The following methodological foundations were the key to the realization of such a task:

- augmented reality in the process of learning mathematics, first of all, helps to visualize mathematical objects (geometric shapes, bodies of function graphs, etc.). It should also be noted that augmented reality in the process of learning mathematics provides such opportunities as moving, rotating, scaling 3D-models, viewing them at any angles, connecting and disconnecting virtual objects and studying the obtained results, and so on;
- students’ research work is an obligatory, integral part of professional training at the university. The development of the system of students’ research work is the most important function of the educational system and an important statutory activity of the university as an educational institution.

To further ensure the involvement of students in the development of AR applications as part of the research work, we developed the content of the activities of the student’s research group (scientific club) “Informatics studios” of the Borys Grinchenko Kyiv University:

Classes 1–4. Technologies of Virtual (VR) and Augmented (AR) Reality in the Educational Process. The essence of virtual and augmented reality technologies, methods of their implementation and areas of application. Operating principles and functionality of AR and VR applications. Classification and comparison of virtual and augmented reality systems. Analysis of practical experience in the use of virtual and augmented reality systems in the educational process. Mixed reality technology.

Classes 5–8. Design technology of educational VR- and AR-applications. Approaches to the design of applications using virtual and augmented reality technologies. Review and analysis of tools for designing the structure of VR- and AR- applications. Comparative characteristics of VR and AR content development tools in browsers.

Classes 9–10. The use of mobile technologies in digital education. The concept of “mobile learning”, opportunities and goals for mobile learning. Characteristics and features of mobile learning. Didactic principles of mobile learning.

Classes 11–12. Application of educational VR and AR applications in mobile education. Mobile applications in the work of the modern teacher. The main problems and limitations of mobile learning technology. Analysis of mobile applications used in the educational process. The use of educational VR and AR applications.

The work of the “Informatics studios” group includes the following tasks:

- Assignment 1. An introduction to the technical devices of virtual and augmented reality.
- Assignment 2. Ways to design the structure of an AR or VR application.
- Assignment 3. Functionality of VR application design tools.
- Assignment 4. Software tools for designing AR applications.
- Assignment 5. Development of educational AR applications and their use in the learning process.
- Assignment 6. Designing educational VR content for use in digital education.
- Assignment 7. Development of surveys and quizzes by means of mobile applications.
- Assignment 8. Creating interactive learning games by means of mobile applications.
- Assignment 9. Development of QR code and its use in the educational process.
- Assignment 10. Methodological peculiarities of the use of educational VR and AR applications in mobile learning.

As the practice of using AR in the educational process, there are still not sufficiently developed methods of using AR. There is a lack of methodological and didactic literature on the implementation of training with the help of AR technology. In addition, requires the development of AR applications to ensure the objectives of the educational process. We solved the problem of limited didactic means by involving students in the development of their own augmented reality objects using specialized programs. It should be noted that such activity has a pronounced interdisciplinary character, because it contributes to the effective integration of such branches as information technology and mathematics. We developed a mobile application and a bank of models corresponding to the school mathematics course. Two topics were chosen: “Polyhedrons” for 11th grade, as well as “Functions, their properties and graphs” for 10th grade. These programs were tested in classes on the methodology of teaching mathematics. After testing the materials at the 3rd International Workshop on Augmented Reality in Education (AREdu 2020 workshop, <https://aredu.ccjournals.eu/aredu2020/>), we decided to update the software toolkit in the context of expanding the visual 3D model base and transferring the standard platform to the game engine based on the suggestions made.

To develop the program, we used the following tools:

- Android Studio (integrated development environment for the Android platform), SDK (a set of development tools, utilities and documentation that allows you to create applications using a particular technology or for a particular platform) and NDK (a set of tools that allow you to implement part of the application using languages such as C/C++/C# to port the application to different devices and code optimization);
- QR Generator is an online tool that allows you to generate tags;
- FTDS Dev is a program that allows you to generate a database and 3D models with labels;
- Google Sceneform (ARCore, Sceneform) is a library and framework for rendering 3D models to devices with control;

- Poly is a library of ready-made 3D models from Google integrated for Daydream. The first step was to load the augmented reality library into Android Studio. After that, import the model with a mathematical description into a specially prepared asset folder.

The first step was to load the augmented reality library into Android Studio. After that, import the model with a mathematical description into a specially prepared asset folder (figure 1).

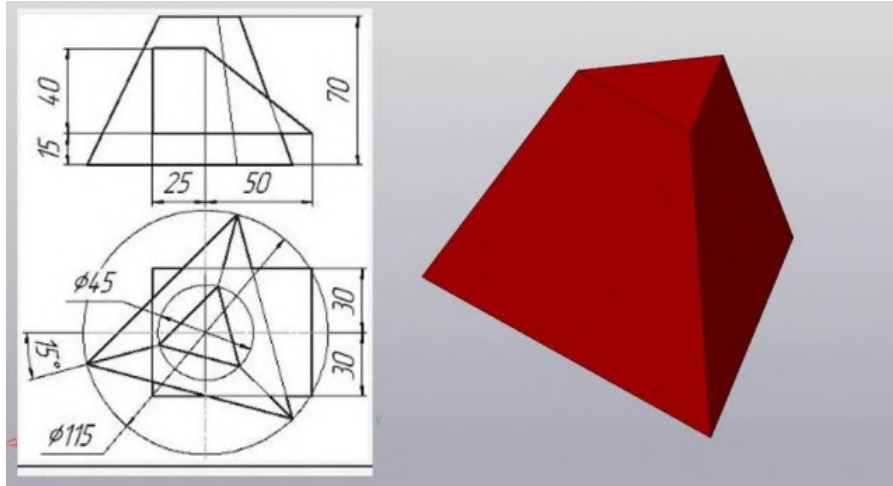

Figure 1: 3D model with parameters.

After generating the processing code, we created a bank of 3D models (figure 2).

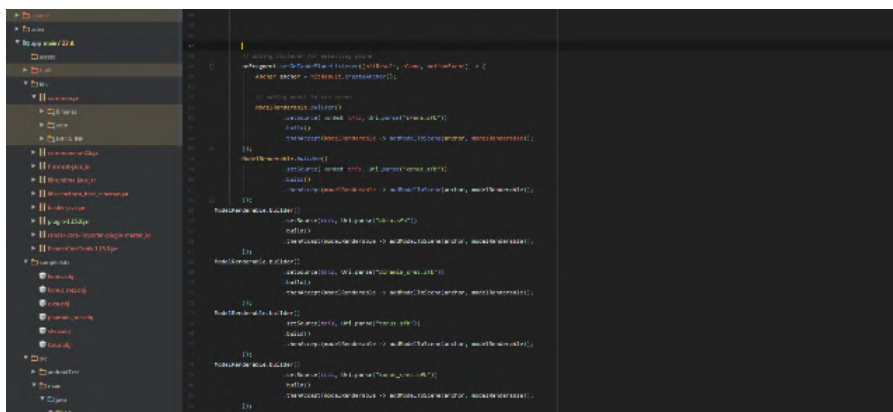

Figure 2: Bank of 3D models with connection without code processing.

The next step was to process the modeling code and render the 3D model. At this stage we created positioning and anchoring to the marker (figure 3).

After compiling the project, we tested it on different devices. Total for 145 Android devices on different OS versions (figure 4).

Smartphone emulation of cone model with parameters in 2D perspective mode without using OpenGL is shown in figure 5.

```

@Override
protected void onCreate(Bundle savedInstanceState) {
    super.onCreate(savedInstanceState);
    setContentView(R.layout.main_activity);
    mFragmentManager = (FragmentManager) getSupportFragmentManager().findFragmentById(R.id.fragment);

    //adding listener for detecting plane
    mFragmentManager.registerFragmentLifecycleCallbacks(new LifecycleCallbacks() {
        @Override public void onFragmentCreated(@NonNull Fragment fragment, @NonNull Bundle savedInstanceState) {
            //adding model to the scene
            ModelRenderable.Builder()
                .setSource(this, Uri.parse("file:///android_asset/models/teapot.glb"))
                .build()
                .loadModel(this, new ModelRenderableOptions.Builder()
                    .setLoadInBackground(true)
                    .build())
                .addListener(new ModelRenderableListener() {
                    @Override public void onLoadComplete(@NonNull Uri uri, @NonNull ModelRenderable modelRenderable) {
                        //adding model to the scene
                        mScene.add(modelRenderable);
                    }
                });
        }
    });

    ModelRenderable.Builder()
        .setSource(this, Uri.parse("file:///android_asset/models/teapot.glb"))
        .build()
        .loadModel(this, new ModelRenderableOptions.Builder()
            .setLoadInBackground(true)
            .build())
        .addListener(new ModelRenderableListener() {
            @Override public void onLoadComplete(@NonNull Uri uri, @NonNull ModelRenderable modelRenderable) {
                //adding model to the scene
                mScene.add(modelRenderable);
            }
        });

    ModelRenderable.Builder()
        .setSource(this, Uri.parse("file:///android_asset/models/teapot.glb"))
        .build()
        .loadModel(this, new ModelRenderableOptions.Builder()
            .setLoadInBackground(true)
            .build())
        .addListener(new ModelRenderableListener() {
            @Override public void onLoadComplete(@NonNull Uri uri, @NonNull ModelRenderable modelRenderable) {
                //adding model to the scene
                mScene.add(modelRenderable);
            }
        });
}

```

Figure 3: 3D model processing code.

In the February 2021 update, we offered the app to 137 individuals for testing: 50 – 10th grade students, 52 – 11th grade students, and 35 university students. All respondents are students of different schools and programming courses in Kyiv. The results of the survey compared to the results of a similar survey for 2020 (table 1).

Table 1
Results of the survey of AR supplement users

Year	Number of respondents	Convenient to work with the application, the number, (%)	Willingness to learn with AR number, (%)
2020	104	94 (90.4%)	48 (46.2%)
2021	137	126 (90.2%)	71 (50.8%)

As a result of the survey, it was found that 126 people found it convenient to use this addendum, which is 90.2%, this is at the level of last year's figure (in 2020 it was 90.4%). In 2020, we noted that only 46.2% of people were convinced that they would like to do teaching assignments with supplemented reality. This was due to the fact that the vast majority of respondents still do not have experience of using AR in the educational process. This clearly indicates that the problem of organizing the educational process with the help of AR requires scientific and methodological solutions. In 2021, the indicator has increased and will be 50.8%. This increase is due to the fact that in the conditions of distance education teachers began to use AR in the educational process more often.

3. Conclusions

1. The analysis of the main AR techniques (marker-based, markerless, projection based on the overlay layer) and requirements for the use of AR revealed the possibilities of AR for the implementation of training and research work of future IT specialists in the university.

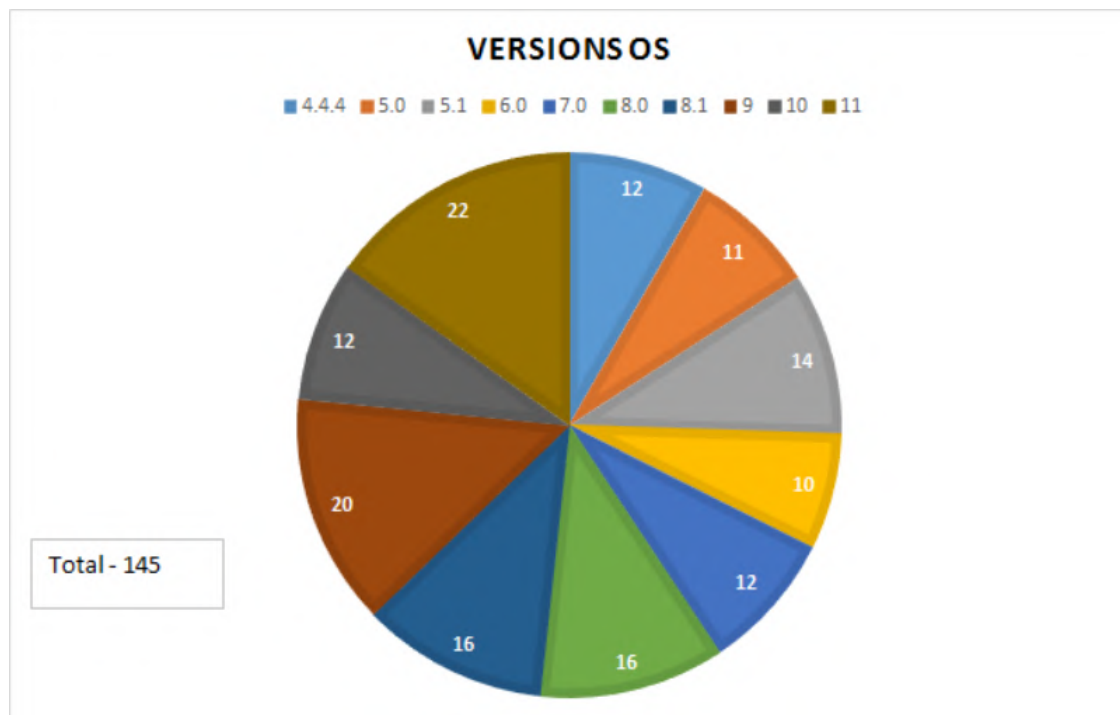

Figure 4: Diagram of the number of tests on the Android OS versions.

Surveys of university teachers allowed to analyze the most popular AR applications for training future IT specialists (AR Ruler, AR Physics, Nicola Tesla, Arloon Geometry, AR Geometry, GeoGebra 3D Graphing Calculator, etc.) And reveal their main advantages (illustration of complex and abstract concepts, accessibility, practice-oriented, increasing student motivation for learning, etc.).

2. To effectively involve future IT specialists in the development of AR applications, the content of the activities of the scientific club “Informatics studios” of the Borys Grinchenko Kyiv University was developed. According to the results of approbation of the previous materials at the the 3rd International Workshop on Augmented Reality in Education (AREdu 2020) within the activity of the scientific circle the students updated the mobile application and model bank corresponding to the topics: “Polyhedrons” for 11th grade, as well as “Functions, their properties and graphs” for 10th grade school mathematics course.
3. The choice of software tools for developing a mobile application (Android Studio, SDK, NDK, QR Generator, FTDS Dev, Google Sceneform, Poly) is justified. The stages of mobile application development (loading the library AR in Android Studio; import models; generation of the processing code; created bank 3D models; processing code modeling and rendering 3D models; positioning and linking to the marker; compilation of the project; testing). As a result of the survey of students and students identified the benefits

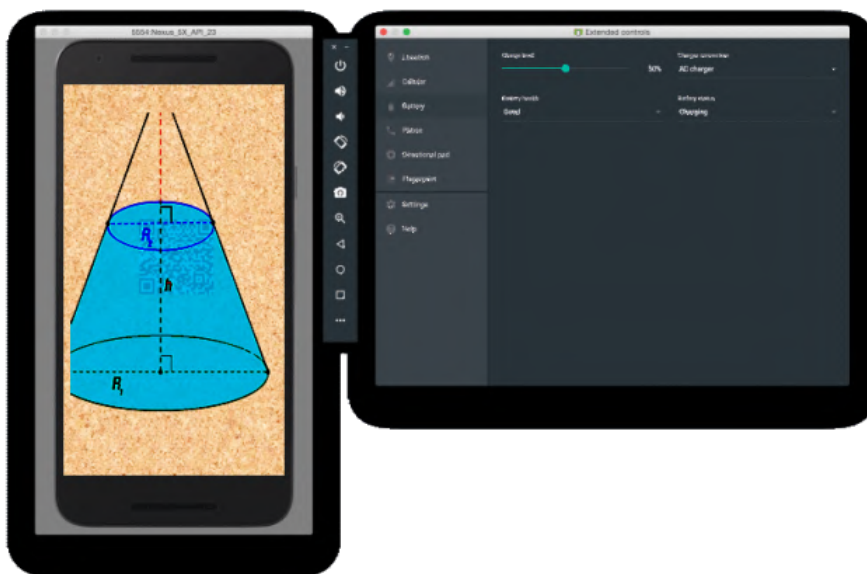

Figure 5: Smartphone emulation.

of using the AR application.

4. Prospects for further research we see in improving the methods of teaching mathematics and computer science disciplines using AR in the process of professional training of future IT specialists.

Acknowledgments

This research was carried out within the scientific theme of the Department of Computer Science and Mathematics of Borys Grinchenko Kyiv University “Theoretical and practical aspects of the use of mathematical methods and information technology in education and science” (state registration number 0116U0046250), as well as within the research laboratory of innovative teaching methods and the department of innovative technologies in pedagogy, also within the themes of scientific research laboratory of innovative methods of teaching and department of innovative technologies in pedagogy and psychology and social work of the Alfred Nobel University “Modernization of professional-pedagogical education in Ukraine in terms of integration into the global educational space” (state registration number 0112U002287) and “Theoretical and methodological principles of competence-based professional education in the context of Eurointegration” (state registration number 0717U004331). The topic of the study corresponds to the directions of scientific research of Luhansk Taras Shevchenko National University.

References

- [1] O. Lavrentieva, I. Arkhypov, O. Kuchma, A. Uchitel, Use of simulators together with virtual and augmented reality in the system of welders' vocational training: Past, present, and future, *CEUR Workshop Proceedings 2547* (2020) 201–216.
- [2] S. Shokaliuk, Y. Bohunencko, I. Lovianova, M. Shyshkina, Technologies of distance learning for programming basics on the principles of integrated development of key competences, *CEUR Workshop Proceedings 2643* (2020) 548–562.
- [3] M. Syvyi, O. Mazbayev, O. Varakuta, N. Panteleeva, O. Bondarenko, Distance learning as innovation technology of school geographical education, *CEUR Workshop Proceedings 2731* (2020) 369–382.
- [4] D. Y. Bobyliev, E. V. Vihrova, Problems and prospects of distance learning in teaching fundamental subjects to future mathematics teachers, *Journal of Physics: Conference Series 1840* (2021) 012002. doi:10.1088/1742-6596/1840/1/012002.
- [5] K. Polhun, T. Kramarenko, M. Maloivan, A. Tomilina, Shift from blended learning to distance one during the lockdown period using Moodle: test control of students' academic achievement and analysis of its results, *Journal of Physics: Conference Series 1840* (2021) 012053. doi:10.1088/1742-6596/1840/1/012053.
- [6] I. S. Mintii, T. A. Vakaliuk, S. M. Ivanova, O. A. Chernysh, S. M. Hryshchenko, S. O. Semerikov, Current state and prospects of distance learning development in Ukraine, *CEUR Workshop Proceedings* (2021).
- [7] A. Striuk, M. Rassovytska, S. Shokaliuk, Using Blippar augmented reality browser in the practical training of mechanical engineers, *CEUR Workshop Proceedings 2104* (2018) 412–419.
- [8] P. Nechypurenko, T. Starova, T. Selivanova, A. Tomilina, A. Uchitel, Use of augmented reality in chemistry education, *CEUR Workshop Proceedings 2257* (2018) 15–23.
- [9] S. Zelinska, A. Azaryan, V. Azaryan, Investigation of opportunities of the practical application of the augmented reality technologies in the information and educative environment for mining engineers training in the higher education establishment, *CEUR Workshop Proceedings 2257* (2018) 204–214.
- [10] T. Kolomoiets, D. Kassim, Using the augmented reality to teach of global reading of preschoolers with autism spectrum disorders, *CEUR Workshop Proceedings 2257* (2018) 237–246.
- [11] T. Kramarenko, O. Pylypenko, V. Zaselskiy, Prospects of using the augmented reality application in STEM-based Mathematics teaching, *CEUR Workshop Proceedings 2547* (2020) 130–144.
- [12] O. Lavrentieva, I. Arkhypov, O. Krupskyi, D. Velykodnyi, S. Filatov, Methodology of using mobile apps with augmented reality in students' vocational preparation process for transport industry, *CEUR Workshop Proceedings 2731* (2020) 143–162.
- [13] I. Mintii, V. Soloviev, Augmented reality: Ukrainian present business and future education, *CEUR Workshop Proceedings 2257* (2018) 227–231.
- [14] P. Nechypurenko, V. Stoliarenko, T. Starova, T. Selivanova, O. Markova, Y. Modlo, E. Shmeltser, Development and implementation of educational resources in chemistry with elements of augmented reality, *CEUR Workshop Proceedings 2547* (2020) 156–167.

- [15] S. P. Palamar, G. V. Bieliienka, T. O. Ponomarenko, L. V. Kozak, L. L. Nezhyva, A. V. Voznyak, Formation of readiness of future teachers to use augmented reality in the educational process of preschool and primary education, *CEUR Workshop Proceedings* (2021).
- [16] O. B. Petrovych, A. P. Vinnichuk, V. P. Krupka, I. A. Zelenenka, A. V. Voznyak, The usage of augmented reality technologies in professional training of future teachers of Ukrainian language and literature, *CEUR Workshop Proceedings* (2021).
- [17] N. Rashevskaya, V. Soloviev, Augmented reality and the prospects for applying its in the training of future engineers, *CEUR Workshop Proceedings* 2257 (2018) 192–197.
- [18] N. Rashevskaya, S. Semerikov, N. Zinonos, V. Tkachuk, M. Shyshkina, Using augmented reality tools in the teaching of two-dimensional plane geometry, *CEUR Workshop Proceedings* 2731 (2020) 79–90.
- [19] S. O. Semerikov, M. M. Mintii, I. S. Mintii, Review of the course “Development of Virtual and Augmented Reality Software” for STEM teachers: implementation results and improvement potentials, *CEUR Workshop Proceedings* (2021).
- [20] D. S. Shepiliev, S. O. Semerikov, Y. V. Yechkalo, V. V. Tkachuk, O. M. Markova, Y. O. Modlo, I. S. Mintii, M. M. Mintii, T. V. Selivanova, N. K. Maksyshko, T. A. Vakaliuk, V. V. Osadchyi, R. O. Tarasenko, S. M. Amelina, A. E. Kiv, Development of career guidance quests using WebAR, *Journal of Physics: Conference Series* 1840 (2021) 012028. doi:10.1088/1742-6596/1840/1/012028.
- [21] R. O. Tarasenko, S. M. Amelina, S. O. Semerikov, V. D. Shynkaruk, Using interactive semantic networks as an augmented reality element in autonomous learning, *Journal of Physics: Conference Series* 1946 (2021) 012023. doi:10.1088/1742-6596/1946/1/012023.
- [22] T. A. Vakaliuk, S. I. Pochtoviuk, Analysis of tools for the development of augmented reality technologies, *CEUR Workshop Proceedings* (2021).
- [23] N. Zinonos, E. Vihrova, A. Pikilnyak, Prospects of using the augmented reality for training foreign students at the preparatory departments of universities in Ukraine, *CEUR Workshop Proceedings* 2257 (2018) 87–92.
- [24] M. Akçayır, G. Akçayır, Advantages and challenges associated with augmented reality for education: A systematic review of the literature, *Educational Research Review* 20 (2017) 1–11. doi:10.1016/j.edurev.2016.11.002.
- [25] J. Martín-Gutiérrez, C. E. Mora, B. Añorbe-Díaz, A. González-Marrero, Virtual technologies trends in education, *Eurasia Journal of Mathematics, Science and Technology Education* 13 (2017) 469–486. URL: <https://www.ejmste.com/article/virtual-technologies-trends-in-education-4674>. doi:10.12973/eurasia.2017.00626a.
- [26] M.-B. Ibáñez, C. Delgado-Kloos, Augmented reality for STEM learning: A systematic review, *Computers & Education* 123 (2018) 109–123. doi:10.1016/j.compedu.2018.05.002.
- [27] O. Syrovatskyi, S. Semerikov, Y. Modlo, Y. Yechkalo, S. Zelinska, Augmented reality software design for educational purposes, *CEUR Workshop Proceedings* 2292 (2018) 193–225. URL: <http://ceur-ws.org/Vol-2292/paper20.pdf>.
- [28] V. V. Osadchyi, K. P. Osadcha, H. B. Varina, S. V. Shevchenko, I. S. Bulakh, Specific features of the use of augmented reality technologies in the process of the development of cognitive component of future professionals’ mental capacity, *Journal of Physics: Conference Series* 1946 (2021) 012022. doi:10.1088/1742-6596/1946/1/012022.
- [29] V. Tkachuk, Y. Yechkalo, S. Semerikov, M. Kislova, Y. Hladyr, Using Mobile ICT for On-

- line Learning During COVID-19 Lockdown, in: A. Bollin, V. Ermolayev, H. C. Mayr, M. Nikitchenko, A. Spivakovsky, M. Tkachuk, V. Yakovyna, G. Zholtkevych (Eds.), *Information and Communication Technologies in Education, Research, and Industrial Applications*, Springer International Publishing, Cham, 2021, pp. 46–67.
- [30] V. Oleksiuk, O. Oleksiuk, Exploring the potential of augmented reality for teaching school computer science, *CEUR Workshop Proceedings 2731* (2020) 91–107.
- [31] V. Shamonina, O. Semenikhina, V. Proshkin, O. Lebid, S. Kharchenko, O. Lytvyn, Using the Proteus virtual environment to train future IT professionals, *CEUR Workshop Proceedings 2547* (2020) 24–36.
- [32] H. Sollervall, M. Milrad, Theoretical and methodological considerations regarding the design of innovative mathematical learning activities with mobile technologies, *International Journal of Mobile Learning and Organisation* 6 (2012) 172–187. URL: <https://www.inderscienceonline.com/doi/abs/10.1504/IJMLO.2012.047595>. doi:10.1504/IJMLO.2012.047595.
- [33] K.-E. Chang, L.-J. Wu, S.-E. Weng, Y.-T. Sung, Embedding game-based problem-solving phase into problem-posing system for mathematics learning, *Computers & Education* 58 (2012) 775–786. doi:10.1016/j.compedu.2011.10.002.
- [34] K. K. Bhagat, C.-Y. Chang, Incorporating GeoGebra into geometry learning – A lesson from India, *Eurasia Journal of Mathematics, Science and Technology Education* 11 (2011) 77–86. URL: <https://www.ejmste.com/article/incorporating-geogebra-into-geometry-learning-a-lesson-from-india-4356>. doi:10.12973/eurasia.2015.1307a.
- [35] T. Kramarenko, O. Pylypenko, I. Muzyka, Application of GeoGebra in Stereometry teaching, *CEUR Workshop Proceedings 2643* (2020) 705–718.
- [36] V. Bilous, V. Proshkin, O. Lytvyn, Development of ar-applications as a promising area of research for students, *CEUR Workshop Proceedings 2731* (2020) 205–216.

The use of augmented reality technologies in the development of emotional intelligence of future specialists of socio-economic professions under the conditions of adaptive learning

Viacheslav V. Osadchyi¹, Hanna B. Varina¹, Kateryna P. Osadcha¹, Olha V. Kovalova¹, Valentyna V. Voloshyna², Oleksii V. Sysoiev³ and Mariya P. Shyshkina⁴

¹*Bogdan Khmelnytsky Melitopol State Pedagogical University, 20 Hetmanska Str., Melitopol, 72300, Ukraine*

²*National Pedagogical Dragomanov University, 9 Pyrohova Str., Kyiv, 01601, Ukraine*

³*Kyiv International University, 49 Lvivska Str., Kyiv, 03179, Ukraine*

⁴*Institute of Information Technologies and Learning Tools of the NAES of Ukraine, 9 M. Berlynskoho Str., Kyiv, 04060, Ukraine*

Abstract

In modern conditions, innovative augmented reality technologies are actively developing, which are widespread in many areas of human activity. Introduction of advanced developments in the process of professional training of future specialists of socio-economic professions in the conditions of adaptive training, contributes to the implementation of the principles of a personalized approach and increase the overall level of competitiveness. The relevant scientific article is devoted to the theoretical and empirical analysis of the features of the implementation of augmented reality technologies in the construct of traditional psychological and pedagogical support aimed at the development of emotional intelligence of the future specialist. The interdisciplinary approach was used while carrying out the research work at the expense of the general fund of the state budget: "Adaptive system for individualization and personalization of professional training of future specialists in the conditions of blended learning". A comprehensive study of the implementation of traditional psychological-pedagogical and innovative augmented reality technologies was conducted in the framework of scientific cooperation of STEAM-Laboratory, Laboratory of Psychophysiological Research and Laboratory of Psychology of Health in Bogdan Khmelnytsky Melitopol State Pedagogical University. The theoretical analysis considers the structural model of emotional intelligence of the future specialist of socio-economic professions, which is represented by two structural components: intrapersonal construct of emotional intelligence and interpersonal construct of emotional intelligence. Each component mediates the inherent emotional intelligence of interpretive, regulatory, adaptive, stress-protective and activating functions. The algorithm of the empirical block of research is presented by two stages: ascertaining and forming research. According to the results of the statement, low indicators were found on most scales, reflecting the general level of emotional intelligence development of future specialists, actualizing the need to find and implement effective measures for the development of emotional intelligence components in modern higher education and taking into account information development and digitalization. As part of the formative stage of the research implementation, a comprehensive program "Development of emotional intelligence of future professionals" was tested, which integrated traditional psychological and pedagogical technologies and innovative augmented reality technologies. This program is designed for 24 hours, 6 thematic classes of 4 hours. According to the results of a comprehensive ascertaining and shaping research, the effectiveness of the influence of augmented reality technologies on the general index of emotional intelligence is proved. The step-by-step model of integration of augmented reality components influencing the ability to analyze, understand and regulate emotional states into a complex program of emotional intelligence development is demonstrated. According to the results of the formative study, there is a dominance of high indicators of the following components: intrapersonal (50%), interpersonal (53.3%). Thus, we can say that intrapersonal and interpersonal emotional intelligence together involve the actualization of various cognitive processes and skills, and are related to each other. Empirical data were obtained as a

result of conducting a psychodiagnostic study on an innovative computer complex HC-psychotest.

Keywords

AR technologies, emotional intelligence, adaptive learning, future specialists of socioeconomic professions

1. Introduction

1.1. The problem statement

New requirements of the society to the level of education, intelligence and development of professionally important personality's traits at different stages of professional genesis necessarily require changes in already developed educational technologies and, accordingly, training technologies for future specialists of socioeconomic professions. There exist current trends in the growth of social demand for an increase of the number of specialists of supporting professions. Under unstable pandemic conditions of the world community's existence, these specialists should be able to provide qualified assistance, demonstrate skills of the use of innovative interactive technologies and have developed IT competencies. At present, technologies, that bring the individual closer to their future professional environment, are significant. The fact of joining the European educational environment and expanding the value-semantic sphere of public consciousness oriented educational content for the value determination of domestic political, legal, socioeconomic, educational and scientific processes and actualized the introduction of innovative information technologies into the process of "new format" specialist's training. Under the revolutionary conditions of the development of modern augmented reality technologies, which allow modeling various professional tasks, the key objective of higher education and science is the actualization of support of youth in the process of their professional development in the renewed value-semantic space of information life. In recent decades, there has been a significant interest of scientists in the issue of emotional intelligence as a factor which influences the quality of person's life, their social status, success and competitiveness. In the comparative table of skills necessary for a successful career, proposed by analysts at the World Economic Forum in Davos at 2016, emotional intelligence is ranked as the sixth issue. Thus, emotionality

AREdu 2021: 4th International Workshop on Augmented Reality in Education, May 11, 2021, Kryvyi Rih, Ukraine

✉ osadchy@mdpu.org.ua (V. V. Osadchy); okp@mdpu.org.ua (K. P. Osadcha); kovalova.ov.mdpu@gmail.com

(O. V. Kovalova); voloshyna.v28@gmail.com (V. V. Voloshyna); 4998858@gmail.com (O. V. Sysoiev);

shyshkina@iitlt.gov.ua (M. P. Shyshkina)

🌐 <https://mdpu.org.ua/new/uk/kafedra-nformatiki-kbernetiki/2990.html> (V. V. Osadchy); <https://inst.mdpu.org.ua/navchalno-naukovij-institut-sotsial/kafedra-psihologiyi/sklad-kafedry-psyhologiyi/varina-ganna-borysivna/>

(H. B. Varina); <http://osadcha.mdpu.org.ua/> (K. P. Osadcha);

<https://inst.mdpu.org.ua/navchalno-naukovij-institut-sotsial/kafedra-psihologiyi/sklad-kafedry-psyhologiyi/kov/>

(O. V. Kovalova); <https://fp.npu.edu.ua/kafedry/56-pro-fakultet/spivrobotnyky/89-voloshyna-valentyina-vitaliivna/>

(V. V. Voloshyna); <http://irbis-nbuv.gov.ua/ASUA/1464945> (O. V. Sysoiev);

<https://iitlt.gov.ua/eng/structure/departments/cloud/detail.php?ID=269> (M. P. Shyshkina)

🆔 0000-0001-5659-4774 (V. V. Osadchy); 0000-0002-0087-4264 (H. B. Varina); 0000-0003-0653-6423 (K. P. Osadcha);

0000-0001-5061-6506 (O. V. Kovalova); 0000-0002-4372-5824 (V. V. Voloshyna); 0000-0001-5899-0244 (O. V. Sysoiev);

0000-0001-5569-2700 (M. P. Shyshkina)

© 2021 Copyright for this paper by its authors.

Use permitted under Creative Commons License Attribution 4.0 International (CC BY 4.0).

 CEUR Workshop Proceedings (CEUR-WS.org)

becomes a more significant factor in a person's success. Emotional intelligence is one of the indicators of the development of professional qualities, as it provides the ability to understand the person's attitudes which are represented by the emotions, to manage their own emotional sphere, which is an important and necessary issue for a modern specialist of socioeconomic professions. In this case, the main objective of future professionals' training is the integration of traditional and innovative training technologies which are aimed at the development of emotional intelligence, individual understanding of socio-normative, personal, professional values and the development of professional self-awareness in general. The achievement of this goal within the framework of higher education, in particular in the field of future specialists' professional training, requires the development and implementation of innovative technologies into the process of the development of specialists' emotional intelligence as a component of sustainable and integrated personal and professional competencies.

The purpose of the article is to comprehensively analyze the features of the implementation of augmented reality components in the development of emotional intelligence of future professionals, taking into account the level of technological progress and the possibilities of modern higher education.

1.2. Literature review

The issue of emotional intelligence is relatively new for the scientific theory (the first studies on this subject appeared in the early 1990s), but nowadays it is a promising and popular research field. Most scholars view emotional intelligence as an integrative formation that includes cognitive, emotional, and personal qualities, and it is an acquired trait, ability/skill that can be developed. The term "emotional intelligence" was introduced into the scientific discourse with the works of Peter Salovey and John D. Mayer (theory of emotional and intellectual abilities), who interpreted it as the ability to track your own emotions and feelings of others, distinguish them and use this information to control thinking and actions [1]; as a complex construct consisting of abilities of three types: identification and expression of emotions, regulation of emotions, use of emotional information in thinking and activity. According to the authors, the structure of emotional intelligence includes 4 components: accuracy of evaluation and expression of emotions, use of emotions in mental activity, understanding of emotions and their management. Goleman [2] interprets emotional intelligence as "people's ability to interpret their own emotions and the emotions of others in order to use this information for the achievement of their own goals" [2]. Lioussine [3] views emotional intelligence as the ability to understand your own emotions and emotions of others and manage them. According to the author, "the ability to understand emotions" means that a person can: recognize emotion, i.e. establish the very fact of having both your own emotional experience or emotional experience of another person; identify an emotion, i.e. realize what kind of emotion he or she feels, and find a verbal expression for it; understand the reasons that caused this emotion and the consequences it will lead to. Lioussine [3] interprets the "ability to manage emotions" as an opportunity/ability to: control the intensity of emotions, first of all, to suppress excessively strong emotions; control the external expression of emotions; arbitrarily evoke one or another emotion. Modern scientific research is reflected in the following studies of foreign and domestic scientists:

- analysis of the relationship between the individual components of IQ and EQ taking into

- account the subjective factor (Gignac [4]);
- analysis of the impact of the leader's emotional intelligence and the productivity and effectiveness of professional activities of his or her subordinates (Ivcevic et al. [5]);
 - diagnostics and development of psychological patterns of emotional intelligence as a condition of mental health (Ihnatovych and Liashch [6]);
 - emotional intelligence as a component of professional suitability and self-realization of preschool educators (Sabol et al. [7]);
 - readiness of future teachers for the development of students' emotional intelligence (Dubovyk et al. [8]).

In modern conditions of robotics development and modernization of the system of relations between artificial systems and the user, Yan et al. [9] presented the results of a comprehensive analysis of the progress of modeling emotional space in HRI. In the context of the information technology introduction into the process of diagnostics and development of emotional intelligence the study of the multimodal mood analysis is also a relevant one [10]. Lawson et al. [11] research the effectiveness of using the Hierarchical Attention – LSTM model based on Cognitive Brain limbic system (HALCB) in the context of neuroprogramming in order to analyze the effectiveness of identifying people's emotional states and reactions. In order to analyze the impact of augmented and virtual reality on the development of emotional intelligence and on the quality of recognition and transmission of relevant emotions by students, scientists have empirically proven the effectiveness of the use of animated virtual pedagogical agents, which demonstrate different range of emotions. In the pandemic conditions, according to Sturgill et al. [12], there exists an increased risk of anxiety, depression and other negative emotional states among students. At the same time, the authors state that with the development of emotional intelligence, as a construct of the body's self-regulatory system, it is possible to reduce the risk of negative emotional states. The researchers analyzed the effectiveness of Ajivar, an application that uses artificial intelligence and machine learning, in order to provide personalized assessment and development of emotional intelligence. Moreover, Dovbysh et al. [13] have proposed to use the information synthesis of the adaptive system in the diagnostics of emotional intelligence and mental state of a person, as this system is based on images of different faces and demonstrates a wide range of emotional states. Elor and Song [14] offer to use the author's ISAM development in the immersive virtual reality, in which the user evaluates the emotions of images using an immersive self-assessment mannequin, thus it will stimulate the development of cognitive structure of emotional intelligence, i.e. the ability to identify and constructively express their own emotions.

Theoretical analysis of the results of the study of the augmented reality technologies impact on various components of human emotional intelligence is presented in table 1.

Summarizing the analysis of the study of various aspects of emotional intelligence, most scientists claim that it is emotional intelligence that provides stress resistance and emotional stability and a balanced, objective and rational decision-making in the field of professional activity. A person with a high EQ skillfully finds a way out of difficult situations, easily and constructively solves problems; such person is friendly and pleasant to communicate with, he or she tries to avoid conflict situations, is self-sufficient and independent, realistically assesses his or her own abilities, such person is a proactive member of the society. Emotional intelligence

as a level of person's emotional awareness, as well as the ability to understand the emotions of other people, are important things for effective communication, which is a very vital quality for representatives of socioeconomic professions.

Table 1: Information on tools for exploring pervasive development

Authors	Study	Concept of study
Anna Ståhl, Kristina Höök, Martin Svensson, Alex S. Taylor, Marco Combetto (2009)	Experiencing the Affective Diary	The authors demonstrate the experience of developing and implementing a digital diary called "Affective Diary", which provides users with an opportunity to write down their notes, but it also allows the users to record data from body sensors and mobile devices regarding certain physiological and emotional states of the users [15].
Diana MacLean, Asta Roseway and Mary Czerwinski (2013)	MoodWings: A Wearable Biofeedback Device for RealTime Stress Intervention	Despite the increasing availability of sensors and methods for detecting stress, little attention has been paid to automated stress interventions and their actions. The authors introduced MoodWings: a wearable butterfly that displays the user's tense state in real time by means of activated wing movement. Researchers have developed MoodWings as a stress alert system and there is also a physical interface that allows users to manipulate their affective state. Accordingly, they have found out that MoodWings helps users to calm down and work better while fulfilling stressful tasks [16].
Daniel McDuff, Amy Karlson, Ashish Kapoor, Asta Roseway, Mary Czerwinski (2012)	AffectAura: An Intelligent System for Emotional Memory	AffectAura allows users to reflect on their emotional states for an extended period of time. Researchers have developed a multimodal sensor setup for continuous recording of audio, visual, physiological and contextual data, a classification scheme for predicting the affective state of the user, and an interface for displaying the user. The system constantly predicts the valence, excitement and activation of the user and associates it with event information, communication and data interaction [17].

Continued on next page

Table 1 – Continued from previous page

Authors	Study	Concept of study
Pablo Paredes, Matthew K. Chan (2011)	CalmMeNow: Exploratory Research and Design of Stress Mitigating Mobile Interventions	The researchers have created four prototypes to study the usability and effectiveness of mobile interventions for stress management: <i>social networks</i> (a text interface using SMS to deliver alarm messages is created), <i>playing games</i> (commercially available mobile games with simple tasks such as mazes and basic interaction games (slopes, moves, rotations) as stimulation of the distraction factor are used), <i>managed acupressure</i> (uses two vibration tactile motors in the bracelet, which stimulate acupressure points in the wrists and chest; these points are known to reduce stress – the researchers used the Wizard of Oz technique to monitor the time of this stimulus), <i>controlled breathing</i> (using the same bracelet, participants are trained to breathe according to known methods of deep breathing; proper breathing rhythm is one of the key elements of achieving a calming effect). Authors researched the effectiveness of this comprehensive approach [18].
Akane Sano, Andrew J. Phillips, Amy Z. Yu, Andrew W. McHill, Sara Taylor, Natasha Jaques, Charles A. Czeisler, Elizabeth B. Klerman, Rosalind W. Picard (2015)	Recognizing Academic Performance, Sleep Quality, Stress Level, and Mental Health using Personality Traits, Wearable Sensors and Mobile Phones	The researchers have collected extensive subjective and objective data through mobile phones, surveys and sensors. The authors have analyzed daily and monthly behavioral and physiological patterns and identified factors that affect performance (GPA), Pittsburgh Sleep Index (PSQI), stress scale (PSS), and overall mental health score (MCS) with SF-12, using the data obtained [19].

In terms of student-centered approach, it is important to take into account the person's individual characteristics at different stages of professional genesis as it serves as a basis in the process of updating adaptive learning systems and building a personalized trajectory of the future specialist. Modern achievements in the development of technology allow expanding the functionality of supporting individual learning trajectories at different stages of professional genesis of students. Scientifically substantiated and pedagogically expedient introduction of modern adaptive systems into the educational environment promotes, according to scientists, the acquisition by this environment of signs of openness, personalization, which will allow access to quality educational content for all subjects, taking into account individual psychological characteristics. Adaptive learning systems are specialized software or services that adapt to the individual needs of individual students in the training process [20, 21]. These tools

are able to synchronize with the learning process, adapt to the progress of each student, and independently adjust educational and developmental content in real time. Adaptive learning systems in comparison with the developments of previous generations, better and faster to configure in the process, have the properties of flexibility, openness to modifications, which ultimately allows for individualization, personalization, personality-oriented approach in the professional development of a competitive specialist [22, 23]. Algorithms embedded in adaptive learning systems evaluate the results of individual progress of each student in real time and, depending on this, adjust the content, pace, etc. The functioning of such systems is based on a competency approach, focus on individual progress. This distinguishes them from traditional learning management systems designed for mass learning, linear courses. The main advantage of adaptive learning systems is their ability to determine how the student, taking into account individual typological features, cognitive, psycho-emotional capabilities, learns, how “progresses” in performing professionally oriented tasks, as well as providing accurate and timely feedback [24]. Given this, we consider relevant and promising to study the theoretical and practical principles of adaptive learning with an innovative component of the combination of traditional psychological and pedagogical technologies and innovative technologies of augmented reality in the development of professionally important qualities of the future specialist. According to the analysis of existing scientific and practical trends and developments on the introduction of modern AR technologies into a comprehensive system of future specialists’ training under the conditions of adaptive learning, nowadays the issue of finding vectors of combining traditional psychological and pedagogical approaches and modern information technologies in the process of competence approach realization and development of emotional intelligence of future specialists of socio-economic professions remains quite branched and understudied issue.

2. Research methods

The interdisciplinary approach was used while carrying out the research work at the expense of the general fund of the state budget: “Adaptive system for individualization and personalization of professional training of future specialists in the conditions of blended learning”, state registration number: 0120U101970. A comprehensive study of the implementation of traditional psychological-pedagogical and innovative augmented reality technologies was conducted in the framework of scientific cooperation of STEAM-Laboratory, Laboratory of Psychophysiological Research and Laboratory of Psychology of Health in Bogdan Khmelnytsky Melitopol State Pedagogical University.

The methods used in the process of research are the following:

- 1) theoretical – analysis, synthesis, comparison, generalization, systematization of theoretical and research data (identification of the research problem and selection of the approaches to the analysis of emotional intelligence of future specialists of socio-economic professions, general principles and advantages of augmented reality technologies in the development of emotional intelligence as a factor of effective professional self-realization, definition of basic research concepts);
- 2) the experiment was conducted in four stages:

- A. organizational stage – formation of a representative sample, development of a program of ascertaining and formative experiment, choice of methods of qualitative and quantitative analysis of empirical data.
- B. ascertaining stage – psychological diagnostics with the help of computer psychodiagnostic complex HC-psychotest and Google Forms:
 - 1. Questionnaire “EmIn” by D. Lioussine. This technique includes four scales (interpersonal and intrapersonal emotional intelligence, emotion recognition and emotion management), five subscales (understanding other people’s emotions, managing other people’s emotions, understanding your own emotions, managing your own emotions, control over expression) and an integrated indicator of overall emotional intelligence, which is a sum of the subscales.
 - 2. Reflexive survey (compiled by the authors using Google Forms) provided an opportunity to summarize the subjective assessment of personal and behavioral changes of respondents after the experimental impact. In our study, we used both qualitative and quantitative approaches to the study of the issue, in order to supplement the results and cross-validate the data obtained.
- C. Formative stage. At the formative stage of the study, a comprehensive program “Development of emotional intelligence of future professionals”, which integrated traditional psychological and pedagogical technologies and innovative augmented reality technologies, was implemented. This program was carried out within the framework of the certification program for future specialists of socio-economic professions “Self-management: development of sanogenic potential of the personality”, which was implemented using Moodle. At the formative stage we integrated traditional psychological training on the use of cognitive-behavioral, relaxation, art-therapy and case-study techniques and the innovative opportunities of gamification with AR technologies. The formative stage was carried out on the basis of STEAM-Laboratory.
- D. Statistical processing of experimental data. The SPSS for Windows 12.0 was used for statistical processing of the data.

3. Research results

The theoretical construct of our study is the analysis of priority opportunities and mechanisms for the use of AR technologies in the development of future specialist’s emotional intelligence in the sphere of higher education under the conditions of adaptive learning. The development of emotional intelligence is one of the areas of psychological and pedagogical support of the professional development of students of the socio-economic type of professions. Taking into account the activity approach, we analyze the model of emotional intelligence of the future specialist of socio-economic professions, which is presented in figure 1.

In the context of the presented structural model, future specialist’s emotional intelligence is represented by two constructs:

- 1. Intrapersonal construct of emotional intelligence:
 - a) Understanding and analysis of emotions:

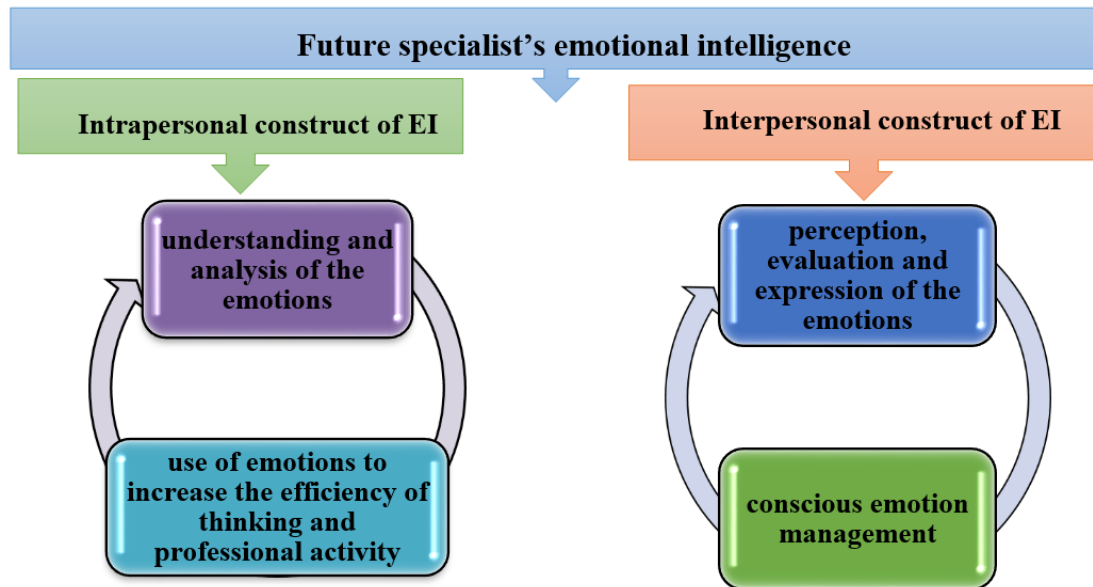

Figure 1: Structural model of emotional intelligence of the future specialist of socioeconomic professions.

- ability to label emotions and verbalize them; understanding the difference between different in name but similar in content emotions (e.g. like and love);
 - ability to interpret the meaning of changes in emotions, understanding of causal relationships (e.g. the emergence of grief after loss);
 - ability to understand a set of feelings, for example: simultaneous love and hate, or such a mixture of feelings as reverent fear (which consists of fear and astonishment);
 - ability to recognize unexpected changes in emotions (e.g. a change in anger for pleasure, or a change in anger for embarrassment).
- b) The use of emotions to improve the effectiveness of thinking and activities:
- use of emotions to focus on priority things which should be thought over, focus on important information;
 - use of bright and accessible emotions as additional aspects of thinking and memory;
 - use of emotional mood swings to change the perspective of individuals (from optimistic to pessimistic) and to expand the diversity of possible views on certain events;
 - actualization of those emotions that contribute to the solution of certain tasks (e.g. a good mood facilitates the solution of creative and practice-oriented tasks).
2. Interpersonal construct of emotional intelligence:
- a) Perception, evaluation and expression of emotions:
- ability to identify emotion in physical states, feelings and thoughts;

- ability to identify the emotions of others reflected in paintings, works of art etc., through language, sound; manifestations and behavior;
 - ability to accurately express emotions and needs associated with these feelings;
 - ability to distinguish exact / inaccurate, real / invalid expressions of feelings.
- b) Conscious management of emotions:
- ability to remain open to feelings both pleasant and unpleasant;
 - ability to consciously pay attention or distract your attention from emotions, depending on the assessment of their informativeness or usefulness;
 - ability to consciously control your own emotions and emotions of others (e.g. to recognize the typicality, influence, clarity of emotions);
 - ability to control your own emotions and emotions of others (e.g. to reduce negative emotions and increase pleasant ones without reducing or enhancing the information they can convey).

Each of these groups of abilities mediates the fact that emotional intelligence has interpretive, regulatory, adaptive, stress-protective and activating functions. The interpretive function of emotional intelligence allows a person to productively decipher emotional information (emotional facial expressions, voice, intonation, etc.), which contributes to the accumulation and systematization of knowledge, as well as to the formation of person's own emotional experience. The regulatory function of emotional intelligence facilitates the state of emotional comfort and ensures the adequacy of the external expression of human emotions. Adaptive and stress-protective functions of emotional intelligence are used to update and stimulate the mental reserves of future professionals in difficult life situations. The activating function of emotional intelligence provides a flexible ability for congruence in communication. Taking into account the rapid process of information modernization of higher education, it is important to analyze the possibility of the impact of augmented reality technologies on the psycho-physiological characteristics of future professionals and develop a procedural model for implementing traditional psychotechnologies and augmented reality technologies into the process of emotional intelligence development.

Augmented reality (AR) is a technology that allows computer programs to create and identify a virtual layer of information with any marker or object in the real physical world [25]. AR technology opens new opportunities for emotional inclusion into the educational process and development of practical skills [26]. The practical combination of virtual and real experience enriches the personality-oriented activities of students, affects their sensory system in terms of educational materials perception [27]. Computer platforms such as Google Glass, MS HoloLens, Google ARCore, Apple ARKit, etc. are used when working with augmented reality technology [28]. The main feature of these technologies is the direct connection to the real world, while virtual reality, which is being gradually introduced into the education system, lacks this feature [29]. Augmented reality technology allows you to simultaneously see and use virtual and real objects in the human world [30]. The research, conducted by Layered together with Neuro-Insight, states that stimulation of the brain's cognitive functions development becomes more effective through the introduction of augmented reality technologies. Thus, impact on the person can be carried out only through the computer screen (sight), with impact on other sense

organs (hearing, sense of smell, position in space, tactile sensations, sensations of temperature, feeling of acceleration), or in various combinations. An example of such technologies is a virtual reality environment in which a person can manipulate virtual objects as real ones: for example, by moving their hands or when you can “add” a real object to a virtual environment, and it will interact with virtual objects. The graphic image is close to reality and it influences the sensory system of the organism, centers of emotional pleasure and promotes the inclusion in the right hemisphere of the brain. Accordingly, the reflection of the simulated space and the effect of personal participation in virtual events make AR technology a relevant psychological and pedagogical tool, which is universal in the training process due to the feeling of real inclusion in a particular situation. In addition, AR technology has the potential to make the training process more effective as it helps to integrate knowledge into reality through emotional engagement [31]. In this regard, when developing a procedural model for the development of future specialist’s emotional intelligence a number of aspects were taken into account. In particular, the development of emotional intelligence through augmented reality technology, as it:

- gives the opportunity to evaluate themselves objectively, respond to life and professional situations adequately, maintain emotional comfort;
- is an effective means of optimizing professional development of students of socioeconomic professions through the development of their emotional readiness for the professional activity;
- has a purposeful impact on the development of individual components.

During the development of this model, three blocks were identified: target, content-operational and analytical (figure 2).

The aim of the proposed model is the development of emotional intelligence of future specialists of socioeconomic professions, which is a way of optimizing their professional development at the stage of professional training under the conditions of adaptive learning.

The relevant program “Development of emotional intelligence of future professionals”, which integrated traditional psychological and pedagogical technologies and innovative technologies of augmented reality, was implemented into the context of empirical research conducted on the basis of STEAM-Laboratory, Laboratory of Psychophysiological Research and Laboratory of Psychology of Health in Bogdan Khmelnytsky Melitopol State Pedagogical University. This study was conducted from September to December 2020 as a part of a certification program for future professionals of socioeconomic professions “Self-management: the development of sanogenic potential of the individual”, which was implemented using the Moodle system. Future psychologists and social workers (the fourth-year students) took part in the ascertaining and formative stages of the experiment.

The sample was randomized, the total number of respondents in the experimental and control groups was 60 people. The sample was formed using a stratometric method with representative modeling. In the framework of our study, by general population, we mean a group of future socioeconomic specialists with certain characteristics. These characteristics are due to the requirements and specifics of future professional activity, age, level of professional integration and the research hypothesis. In our study, we suggested that the use of augmented reality technologies

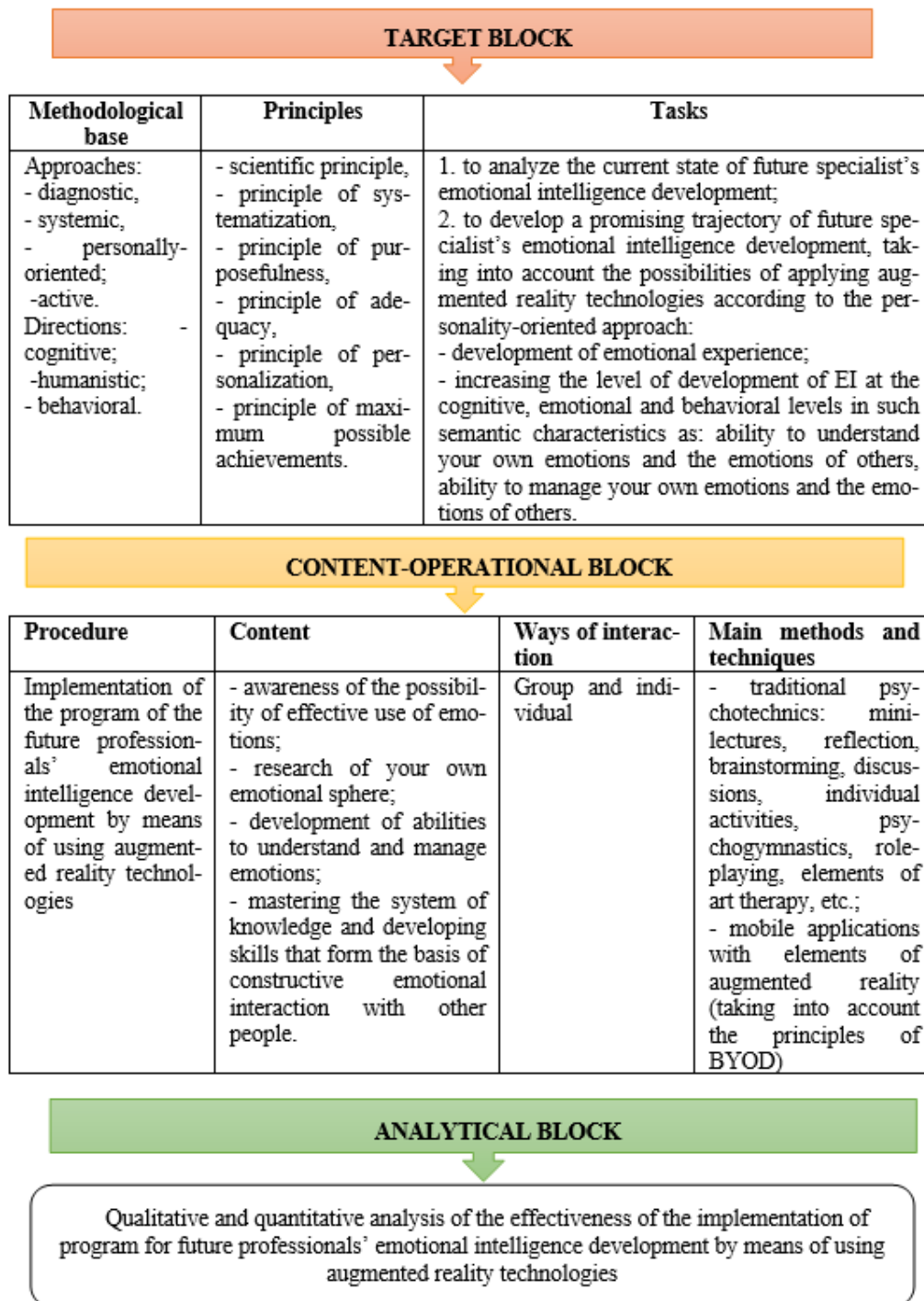

Figure 2: Model of introduction of augmented reality technologies in the process of development of emotional intelligence of future specialists.

in the process of professional training at the stage of initial integration into the profession has a positive effect on the development of emotional intelligence of future professionals of socio-economic professions. Also, in the process of forming a randomized sample, the possibility of the influence of an additional parameter – the individual psychological characteristics of the respondent, which were recorded in the protocols and forms of the study, was not excluded.

The diagnostic unit of the research was implemented on the basis of the Laboratory of Psychophysiological Research using the hardware-software complex (APC) “HC-Psychotest”, which includes many different psychological and psychophysiological techniques that allow researchers to implement a multilevel approach to solving practical diagnostic problems. As a result of the use of this complex in the field of psychodiagnostics, the Laboratory of Psychophysiological Research uses models that interpret test results through various psychodiagnostic techniques, computer versions of psychodiagnostic techniques with automated psychodiagnostic output in the form of coherent, consistent text. In the framework of our study, the complete set “Candidate” was used (figure 3). It is an effective and easy-to-use tool for career guidance and professional selection of candidates for the vacancies regardless of their work experience. “Candidate” provides an opportunity to assess the level of professionally important psycho-physiological qualities and professional competencies, as well as to predict the further development of the specialist and to conduct in-depth professional psychodiagnostics.

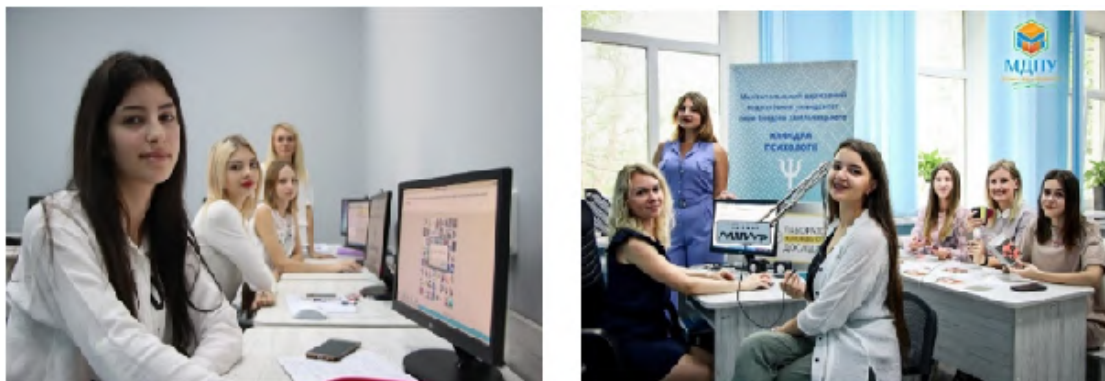

Figure 3: Carrying out diagnostic procedures with the help of the computer complex HC-psychotest.

The psychodiagnostic procedures were conducted in two stages (primary diagnosis – September 2020, secondary diagnosis – December 2020). In order to identify the dominant level of emotional intelligence of future specialists of socio-economic professions, we chose the questionnaire of emotional intelligence “EmIn” by D. Lioussine. One of its advantages is that in addition to five subscales and four general scales, it also has a general scale of results. According to this method, we obtained the following average scores on the sample, which are shown in table 2.

According to the results of the ascertaining experiment, the dominance of the low level of development of the general index of future specialists’ emotional intelligence (50%) was identified. When analyzing the components of emotional intelligence of the individual we found out the following indicators:

Table 2

Diagnostic quantitative indicators according to the questionnaire “Emln” by D. Lioussine

Scales	Very low	Low	Medium	High	Very high
InterEI (interpersonal emotional intelligence):	13.3% (8)	58.3 % (35)	21.7% (13)	6.7% (4)	0% (0)
InterU (understanding of other people’s emotions)	8.3% (5)	61.7% (37)	25% (15)	5% (3)	0% (0)
InterM (management of other people’s emotions)	18.3% (11)	53.3% (32)	16.7% (10)	11.7% (7)	0% (0)
IntraEI (intrapersonal emotional intelligence):	10% (6)	43.3% (26)	35% (21)	6.7% (4)	5% (3)
IntraU (understanding of your own emotions)	10% (6)	30% (18)	48.3%(29)	8.3% (5)	3.4% (2)
IntraM (management of your own emotions)	15% (9)	55% (33)	25% (15)	5% (3)	0% (0)
IntraE (control over expression)	6.7% (4)	46.7% (28)	33.3% (20)	8.3% (5)	5% (3)
UE (understanding of emotions)	8.3% (5)	46.7% (28)	36.6% (22)	6.7% (4)	1.7% (1)
ME (management of emotions)	13.3% (8)	51.7% (31)	25% (15)	8.3% (5)	1.7% (1)
General emotional intelligence	11.7% (7)	50% (30)	30% (18)	6.7% (4)	1.7% (1)

- dominance of low level of development of interpersonal emotional intelligence (58.3%). Within the framework of this component, a low level of development was found on the scales of InterU (understanding of other people’s emotions) – 61.7% and InterM (management of other people’s emotions) – 53.3%. Accordingly, respondents experience difficulties in analyzing and interpreting other people’s emotional states based on external manifestations of emotions (facial expressions, gestures, sound of the voice) and/or intuitively; have difficulties in showing sensitivity and empathy for other people’s inner states;
- dominance of low level of development of intrapersonal emotional intelligence (58.3%). The corresponding result is reflected in a low level of development on such scales as ME (management of the emotions) – 55%, IntraE (control over expression) – 46.7%. At the same time, the ability to understand your own emotions: recognition and identification, understanding of the causes, ability for verbal description, which is reflected in the scale of UE (understanding of emotions) is at the medium level of the development – 48.3% (29).

Thus, low indicators on most scales, which reflect the overall level of future professionals’ emotional intelligence development, prove the need to search for and implement effective measures for the development of components of emotional intelligence in modern establishments of higher education. The trends in information development and digitalization should be also taken into account.

In the process of planning, development and implementation of the formative stage of the empirical study, the total sample of respondents was divided into a control group ($n = 30$) and an experimental group ($n = 30$). The experimental group included students who have low rates of emotional intelligence on five scales. During October-November 2020, the experimental group took part in a comprehensive program “Development of emotional intelligence of future professionals”, which integrated traditional psychological and pedagogical technologies and innovative augmented reality technologies (table 3). This program is designed for 24 hours, 6 thematic classes of 4 hours. Students of the experimental group participated in the program twice a week. The corresponding program was implemented on the basis of the Laboratory of Psychology of Health and STEAM-Laboratory.

Table 3: The structure of the complex program “Development of emotional intelligence of future professionals” with the elements of augmented reality

Thematic planning	Aim	Traditional psychotechnics	AR technologies
Block I. Development of intrapersonal emotional intelligence			
1. Getting to know each other. Emotions and their role in professional and personal life	<ul style="list-style-type: none"> • participants’ acquaintance with the ground rules and opportunities this training provides; • brainstorming ideas about emotions, emotional intelligence; • acquaintance with the main mistakes and prejudices in the world of emotions and “mistakes of thinking”. 	exercises: “Poem”, “Guess the emotion”, “Write down the emotions”; goal-setting: “Drawing of the palm”; brainstorming: “Positive and negative sides of emotions”; mini-lecture: “The concept of emotions and EI”, discussion: “Why do we need different emotions?”	Aryzon AR Studio AR Study

Continued on next page

Table 3 – Continued from previous page

Thematic planning	Aim	Traditional psychotechnics	AR technologies
2. Understanding your own emotions	<ul style="list-style-type: none"> • research of your own emotional sphere; • development of abilities to understand your own emotions; • improvement of the ability to accept your own emotions. 	exercises: “Stereotypes of emotions understanding”, “Words”, “Irrational thoughts”, “Emotion-Event-Thought”, “10 situations”; projective drawing: “Magic world of emotions”; mini-lecture: “Understanding emotions”.	Moment AR Emotions
3. Ways of managing your own emotions. Work with negative emotions	<ul style="list-style-type: none"> • development of abilities to manage your own emotions; • awareness of the causes of negative emotions; • acquaintance with the basic techniques of reducing psycho-emotional stress. 	exercises: “Draw the mood”, “My negative emotions”; “Causes of negative emotions”, “Scale of emotions”, “Path of emotions”, “Me-statement”; visualization “Temple of Silence”; mini-lecture: “Algorithm for working off negative emotions”	Paint Draw AR Interactive sandpit
Block II. Development of interpersonal emotional intelligence			
4. Understanding other people’s emotions. Verbal and nonverbal indicators of emotions	<ul style="list-style-type: none"> • development of the ability to empathize; • development of the ability to understand other people’s emotions; • understanding emotional messages and corresponding reactions of the interlocutor. 	exercises: “Pass the emotion”, “Unexpected guest”, “Headbands”, “Story with three emotions”, “Verbalization of emotions of others”, “Phone conversation”, “Epithets”, mini-lecture “Expression of emotions”	AR effect AR Camera Virtual Hologram Photo Editor App Body Language Psychology Secrets

Continued on next page

Table 3 – Continued from previous page

Thematic planning	Aim	Traditional psychotechnics	AR technologies
5. Establishing constructive relationships with other people: emotional aspect	<ul style="list-style-type: none"> • development of other people's emotions management skills; • study of barriers to emotional interaction; • mastery of knowledge and development of skills that form the basis of constructive emotional interaction. 	<p>exercises: "Manipulation warm-up", "Depreciation", "Acceptance of emotions of others", "Reflection on emotions", "Constructive relations"; discussion "Influence of emotional states of others"; mini-lecture "Algorithm for managing the emotions of others"</p>	<p>How Are You Feeling? Clay + Augmented Reality Alyssa - Virtual & AR Talking Girl Simulator</p>
6. Round-up. reflection	Self- <ul style="list-style-type: none"> • evaluation of your own achievements and analysis of development prospects 	<p>exercises: "My achievements (collage)", feedback techniques</p>	<p>Universe of Emotions</p>

Analysis of the impact of AR technology elements (from the Google Play library) on the development of person's emotional intelligence components:

- *AR effect.* Using the application to create AR effects, you can add virtual characters to photos and videos, as well as entire virtual scenes in order to analyze and interpret the emotional world of a person. Available ready-made themes allow you to insert various elements into the image, control emotional expressions, wear "emotional" face masks. Your video search engine can show stunning augmented reality scenes based on the world around you and scenes of interpersonal interaction. Face recognition technology, provided by Sony and SmartAR mechanism, allow you to automatically recognize faces and 3D objects and add elements of augmented reality to them. And the palm recognition mechanism allows you to identify the palms of people in shot, provides even more opportunities to insert interesting additions to people's emotional reactions.
- *Paint Draw AR.* In Paint Draw AR, the respondent has the opportunity to create three-dimensional drawings. The use of appropriate art technology reduces internal psycho-emotional stress, gives a chance to analyze your own emotional state from the point of view "here and now" and actualizes the manifestation of positive emotions.
- *Aryzon AR Studio.* The corresponding application brings augmented reality into a completely new dimension, provides the chance to view 3D models from Sketchfab and Google

Poly, save them in your library and model them. As part of the program, respondents are invited to compile their own catalog of emotional images from various spheres of personal and professional life.

- *Moment AR*. This app requires a MERGE Cube and a smartphone or tablet. The corresponding application was installed on tablets in the Laboratory of Psychology of Health and used within the theme “Understanding your own emotions”. Moment works with Merge Cube to provide an interactive audiovisual experience based on the real world, and uses the latest augmented reality technologies. You need to bring the camera of the mobile device to the Merge Cube, and the interactive and exciting characters of the Moment application come to life. The characters represent different emotions and depict a wide range of emotional situations and social interactions. The respondent chooses from many different emotional situations by simply tapping on different characters on the screen.
- *Emotions*. The corresponding application allows you to visualize, accumulate and interpret the relationship of personal emotional state and certain life events, which is an important component in the process of developing a constructive coping strategy of behavior in various stressful situations.
- *How Are You Feeling? Clay + Augmented Reality*. With the help of playing cards “I’m Clay Feelings Kit” in augmented reality students have the opportunity to explore the features of the main emotions, change them, analyze situations that contribute to the manifestation of certain emotions, develop a strategy to overcome negative emotional states.
- *AR Camera Virtual Hologram Photo Editor App*. With the help of this application, program participants can create their own library of holographic images of different emotional states of people, it develops the ability to recognize and analyze the emotional world of the individual.
- *Alyssa - Virtual & AR Talking Girl Simulator*. The application presents a realistic girl with natural facial expressions, emotions and movements. It provides an opportunity to analyze different situations and your own emotional states and finally it leads to building a communicative process.
- *Universe of Emotions*. The application is used for the analysis of your own emotions and significantly develops emotional intelligence. The application library presents a range of more than 2000 emotions. The user can label his or her emotional state.
- *Body Language Psychology Secrets*. The application is focused on the development of non-verbal communication skills and the ability to recognize the semantic context of certain gestures, poses, pantomime.
- *AR Study*. This application is used by students to analyze the psychophysiological mechanisms of the person’s emotional-volitional sphere and to identify certain disorders.

An integrative combination of traditional psychotechnologies, based on art therapy, psychodrama, gestalt therapy and coaching technologies, is an innovative component in the structure of the program “Development of emotional intelligence of future professionals”. The program was piloted on the basis of the Laboratory of Psychology of Health (figure 4 (a)) and

used augmented reality technologies, provided due to the material and technical support of the STEAM-Laboratory (figure 4 (b))

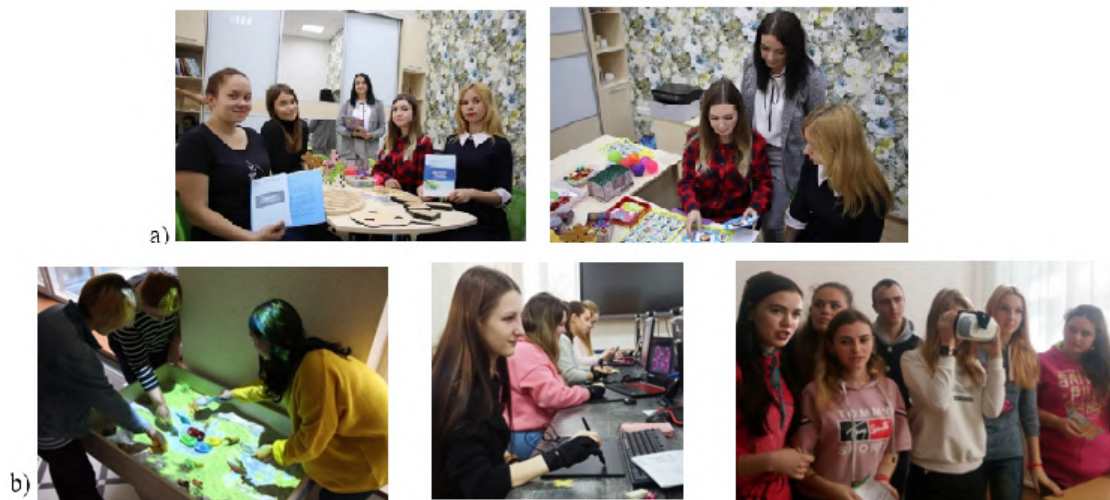

Figure 4: Practical implementation of the program “Development of emotional intelligence of future professionals” with the introduction of elements of augmented reality.

In the context of the analysis of the formative experiment effectiveness a secondary diagnostic study was conducted with the control and experimental groups’ respondents in December 2020. Psychodiagnostic research was also done using the computer complex HC-psychotest. According to the results of the formative research, a certain dynamics in the process of development of emotional intelligence of future specialists of socioeconomic professions was revealed (figure 5).

Accordingly, the results of the analysis of the effectiveness of “Development of emotional intelligence of future professionals” program with components of AR technologies, the following issues were found out:

- an increase in the general level of emotional intelligence development, dominance of a high level – 53.3%. Such results demonstrate the dynamic development of future professionals’ ability to understand their own emotions and emotions of other people and manage them;
- an increase in the level of understanding of emotional states, dominance of high indicators on the corresponding scale (46.7%). High scores on the scale of “ability to understand emotions” show that future professionals have significantly developed the ability to recognize emotion, i.e. to establish the very fact of the presence of their own emotional experience as well as the emotional experience of other people; these respondents have the ability to identify the emotion, or to identify what kind of emotion is felt by the future specialist or another person; they also have demonstrated the ability to verbalize emotional states. It was found out that by the end of this program, future professionals have learnt to establish causal links between emotional states, to understand the peculiarities of

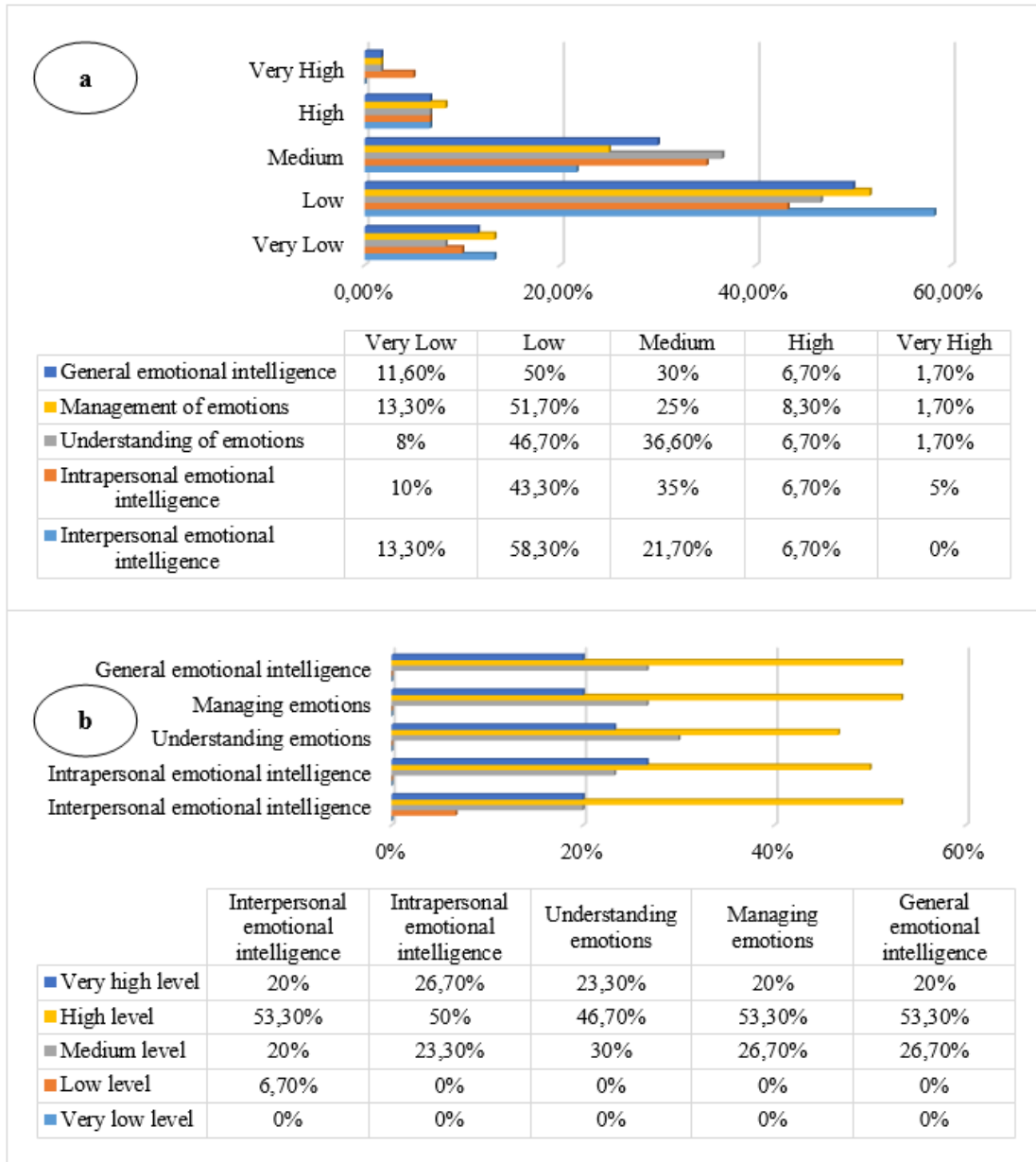

Figure 5: Dynamics of development of emotional intelligence of future specialists in the conditions of introduction of augmented reality technologies: a) the results of the control group of respondents; b) the results of the experimental group of respondents.

- different emotions, to analyze the cause of their occurrence and the impact of emotional state on the effectiveness of tasks fulfillment in the process of professional activity;
- according to the results of the comprehensive program piloting an increase in the level of

self-control over emotional states and the overall level of emotional management (53.3%) was revealed. The ability to manage emotions means that the future specialist can control the intensity of emotions, first of all, suppress excessively strong emotions; he or she is able to control the external expression of emotions, if necessary, arbitrarily evoke a particular emotion. These respondents have the ability to understand and control both their own emotions and the emotions of others.

General emotional intelligence consists of two components: interpersonal and intrapersonal emotional intelligence. According to the results of the formative research an increase in the level of these components development was identified. Thus, there is a dominance of high indicators of these components: intrapersonal (50%), interpersonal (53.3%). So, we can say that the combination of intrapersonal and interpersonal emotional intelligence stimulates the actualization of various cognitive processes and skills, and types of emotional intelligence are related to each other. In order to statistically analyze the effectiveness of the implementation of emotional intelligence development program, we used Wilcoxon's T-criterion, which is aimed at the assessment of the difference between two conditions using experimental data with repeated measurements. The study with repeated measurements includes only one sample, and each respondent in the sample is measured twice. The difference between two dimensions for each person is recorded as an estimate for that person. The Wilcoxon criterion requires that the differences should be ranked from smallest to largest in terms of their absolute value, regardless of sign or direction. In the context of using this criterion, the following hypotheses were stated:

H_0 : There is no difference between two methods. Thus, in the general population there is no tendency for differences to be systematically positive or systematically negative. In the conditions of our research it is the presence of no statistically significant changes in the indicators of emotional intelligence before and after the experimental impact.

H_1 : there is a difference between two methods. Thus, in the general population, differences in indicators are systematically positive or systematically negative. In the conditions of our research it is the presence of significant positive changes – an increase in the level of the components of emotional intelligence development and an increase in the overall index of emotional intelligence as a result of experimental impact. After the statistical data processing in the control group, no significant changes in the level of development of emotional intelligence were identified.

According to the results of statistical processing of empirical data Wilcoxon criterion, we found statistically significant variables in the indicators of the general level of development of emotional intelligence among the respondents of the experimental group. Thus, at $T_{emp} = 82$

$$T_{contr} = \begin{cases} 151 & (p \leq 0.05) \\ 120 & (p \leq 0.01) \end{cases}$$

Accordingly, $T_{emp} < T_{contr}$, building an axis of significance:

Analysis of the axis of significance shows that the relevant rates fall into the zone of significance. Thus, we accept hypothesis H_1 and can claim that the variables recorded in the experiment are not random, but are significant at the 1% level. Accordingly, a comprehensive program for the development of emotional resilience with components of augmented reality, implemented in the certification program for future professionals of socio-economic professions

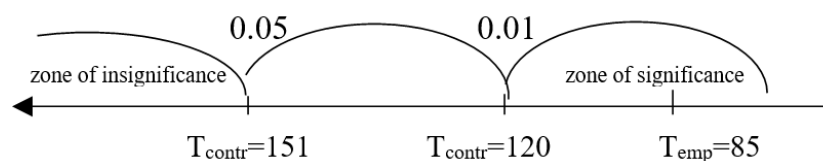

“Self-management: development of sanogenic potential of the individual”, implemented through Moodle, contributed to the development of emotional intelligence of future professionals socio-economic professions and is an effective tool in the development of professionally important qualities in terms of adaptive learning.

4. Conclusions and recommendations for future research

In the process of professional development of future specialists of socio-economic professions affiliative needs, the desire for a sense of self-worth are especially pronounced. However, these aspirations do not always coincide with the real possibilities. Increased emotional sensitivity can both promote and complicate the processes of interpersonal interaction, integration into the profession, stimulating in the latter case the emergence of uncomfortable emotional states. It is the ability of the future specialist to effectively manage emotional states determines a positive mood in communication and allows the choice of attractive behavior in relation to the environment and stimulates the desire for active social interaction in the process of solving professional problems. Reflection of one’s own emotional experiences in relation to problematic or stressful situations of professional interaction encourages a rational correlation of the desired communicative behavior and real communicative opportunities, which also contributes to the conscious choice of status positions in communication and professional self-realization. Analysis of the phenomenology of emotional intelligence in the implementation of a comprehensive program with elements of augmented reality in the context of adaptive learning showed the positive dynamics of intrapersonal transformations (from awareness of emotional experiences to awareness of communicative choices and coping strategies, which in some way affects conscious choice tasks). The “training effects” identified during the correctional and developmental work confirm the importance of reflection emotional experiences in the process of interaction and the specifics of the application of augmented reality technologies in integration emotional and intellectual processes. According to the results of implementation and testing of the development program with elements of augmented reality, it was found that increasing the ability to understand and manage emotions by specially organized means promotes the development of components and general level of emotional intelligence, optimization of sociopsychological adaptation – involvement in integration processes and professional activities. The determined efficiency of integration of augmented reality technologies and traditional psychological and pedagogical techniques becomes a priority direction of reforming the system of adaptive learning in the context of professional training, which, in turn, actualizes the prospects of further research on relevant issues.

References

- [1] P. Salovey, J. D. Mayer, Emotional intelligence, *Imagination, Cognition and Personality* 9 (1990) 185–211. doi:10.2190/DUGG-P24E-52WK-6CDG.
- [2] D. Goleman, *Emotional Intelligence: Why It Can Matter More Than IQ*, 10th anniversary edition ed., Random House Publishing Group, 2005.
- [3] D. Lioussine, Components of emotional intelligence and their relations with personality traits and gender, in: *Psychology in dialogue with related disciplines*. 8th European Congress of Psychology, European Federation of Psychologists' Associations, Wien, 2003, p. 196.
- [4] G. E. Gignac, People who consider themselves smart do not consider themselves interpersonally challenged: Convergent validity evidence for subjectively measured IQ and EI, *Personality and Individual Differences* 174 (2021) 110664. doi:10.1016/j.paid.2021.110664.
- [5] Z. Ivcevic, J. Moeller, J. Menges, M. Brackett, Supervisor emotionally intelligent behavior and employee creativity, *Journal of Creative Behavior* 55 (2021) 79–91. doi:10.1002/jocb.436.
- [6] E. Ihnatovych, O. Liashch, The psychological patterns of emotional intelligence development in adolescence as a condition of personal mental health, *Psychiatry, Psychotherapy and Clinical Psychology* 11 (2020) 802–811.
- [7] D. M. Sabol, L. I. Melenets, O. P. Tretyak, V. M. Shcherbyna, A. Y. Kulbediuk, Research of the level of emotional intelligence of preschool teachers-methodologists, *Journal of Intellectual Disability - Diagnosis and Treatment* 8 (2020) 76–86. doi:10.6000/2292-2598.2020.08.01.10.
- [8] S. H. Dubovyk, A. Y. Mytnyk, N. O. Mykhalchuk, E. E. Ivashkevych, N. O. Hupavtseva, Preparing future teachers for the development of students' emotional intelligence, *Journal of Intellectual Disability - Diagnosis and Treatment* 8 (2020) 430–436. doi:10.6000/2292-2598.2020.08.03.20.
- [9] F. Yan, A. M. Iliyasu, K. Hirota, Emotion space modelling for social robots, *Engineering Applications of Artificial Intelligence* 100 (2021) 104178. doi:10.1016/j.engappai.2021.104178.
- [10] Y. Li, K. Zhang, J. Wang, X. Gao, A cognitive brain model for multimodal sentiment analysis based on attention neural networks, *Neurocomputing* 430 (2021) 159–173. doi:10.1016/j.neucom.2020.10.021.
- [11] A. P. Lawson, R. E. Mayer, N. Adamo-Villani, B. Benes, X. Lei, J. Cheng, Do learners recognize and relate to the emotions displayed by virtual instructors?, *International Journal of Artificial Intelligence in Education* 31 (2021) 134–153. doi:10.1007/s40593-021-00238-2.
- [12] R. Sturgill, M. Martinasek, T. Schmidt, R. Goyal, A novel artificial intelligence-powered emotional intelligence and mindfulness app (Ajivar) for the college student population during the COVID-19 pandemic: Quantitative questionnaire study, *JMIR Form Res* 5 (2021) e25372. URL: <http://formative.jmir.org/2021/1/e25372/>. doi:10.2196/25372.
- [13] A. Dovbysh, I. Shelehov, D. Prylepa, I. Golub, Information synthesis of adaptive system for visual diagnostics of emotional and mental state of a person, *Eastern-European Journal of Enterprise Technologies* 4 (2016) 11–17. URL: <http://journals.uran.ua/eejet/article/view/75683>. doi:10.15587/1729-4061.2016.75683.

- [14] A. Elor, A. Song, iSAM: Personalizing an artificial intelligence model for emotion with pleasure-arousal-dominance in immersive virtual reality, in: 2020 15th IEEE International Conference on Automatic Face and Gesture Recognition (FG 2020), 2020, pp. 572–576. doi:10.1109/FG47880.2020.00091.
- [15] A. Ståhl, K. Höök, M. Svensson, A. S. Taylor, M. Combetto, Experiencing the Affective Diary, *Personal and Ubiquitous Computing* 13 (2009) 365–378. doi:10.1007/s00779-008-0202-7.
- [16] D. MacLean, A. Roseway, M. Czerwinski, MoodWings: A wearable biofeedback device for real-time stress intervention, in: Proceedings of the 6th International Conference on Pervasive Technologies Related to Assistive Environments, PETRA '13, Association for Computing Machinery, New York, NY, USA, 2013. doi:10.1145/2504335.2504406.
- [17] D. McDuff, A. Karlson, A. Kapoor, A. Roseway, M. Czerwinski, AffectAura: An intelligent system for emotional memory, in: Proceedings of the SIGCHI Conference on Human Factors in Computing Systems, CHI '12, Association for Computing Machinery, New York, NY, USA, 2012, p. 849–858. doi:10.1145/2207676.2208525.
- [18] P. Paredes, M. Chan, CalmMeNow: Exploratory research and design of stress mitigating mobile interventions, in: CHI '11 Extended Abstracts on Human Factors in Computing Systems, CHI EA '11, Association for Computing Machinery, New York, NY, USA, 2011, p. 1699–1704. doi:10.1145/1979742.1979831.
- [19] A. Sano, A. J. Phillips, A. Z. Yu, A. W. McHill, S. Taylor, N. Jaques, C. A. Czeisler, E. B. Klerman, R. W. Picard, Recognizing academic performance, sleep quality, stress level, and mental health using personality traits, wearable sensors and mobile phones, in: 2015 IEEE 12th International Conference on Wearable and Implantable Body Sensor Networks (BSN), 2015, pp. 1–6. doi:10.1109/BSN.2015.7299420.
- [20] O. Haranin, N. Moiseienko, Adaptive artificial intelligence in RPG-game on the Unity game engine, *CEUR Workshop Proceedings* 2292 (2018) 143–150.
- [21] M. Marienko, Y. Nosenko, A. Sukhikh, V. Tataurov, M. Shyshkina, Personalization of learning through adaptive technologies in the context of sustainable development of teachers' education, *E3S Web of Conferences* 166 (2020) 10015. doi:10.1051/e3sconf/202016610015.
- [22] M. Petrova, M. Mintii, S. Semerikov, N. Volkova, Development of adaptive educational software on the topic of “Fractional Numbers” for students in grade 5, *CEUR Workshop Proceedings* 2292 (2018) 162–192.
- [23] V. Osadchyi, I. Krashenninik, O. Spirin, S. Koniukhov, T. Diuzhykova, Personalized and adaptive ICT-enhanced learning: A brief review of research from 2010 to 2019, *CEUR Workshop Proceedings* 2732 (2020) 559–571.
- [24] K. Osadcha, V. Osadchyi, S. Semerikov, H. Chemerys, A. Chorna, The review of the adaptive learning systems for the formation of individual educational trajectory, *CEUR Workshop Proceedings* 2732 (2020) 547–558.
- [25] S. Zelinska, A. Azaryan, V. Azaryan, Investigation of opportunities of the practical application of the augmented reality technologies in the information and educative environment for mining engineers training in the higher education establishment, *CEUR Workshop Proceedings* 2257 (2018) 204–214.
- [26] P. Nechypurenko, V. Stoliarenko, T. Starova, T. Selivanova, O. Markova, Y. Modlo,

- E. Shmeltser, Development and implementation of educational resources in chemistry with elements of augmented reality, *CEUR Workshop Proceedings 2547* (2020) 156–167.
- [27] N. Rashevskaya, V. Soloviev, Augmented reality and the prospects for applying it in the training of future engineers, *CEUR Workshop Proceedings 2257* (2018) 192–197.
- [28] T. Kramarenko, O. Pylypenko, V. Zaselskiy, Prospects of using the augmented reality application in STEM-based Mathematics teaching, *CEUR Workshop Proceedings 2547* (2020) 130–144.
- [29] N. Zinonos, E. Vihrova, A. Pikilnyak, Prospects of using the augmented reality for training foreign students at the preparatory departments of universities in Ukraine, *CEUR Workshop Proceedings 2257* (2018) 87–92.
- [30] I. Mintii, V. Soloviev, Augmented reality: Ukrainian present business and future education, *CEUR Workshop Proceedings 2257* (2018) 227–231.
- [31] T. Kolomoiets, D. Kassim, Using the augmented reality to teach of global reading of preschoolers with autism spectrum disorders, *CEUR Workshop Proceedings 2257* (2018) 237–246.

Development of the health-preserving competence of a physical education teacher on the basis of N. Bernstein's theory of movements construction using virtual reality technologies

Mykola B. Yevtuch¹, Vasyl M. Fedorets², Oksana V. Klochko³, Mariya P. Shyshkina⁴ and Alla V. Dobryden⁵

¹*Institute of Pedagogy of the NAES of Ukraine, 52-D Sychvykh Striltsiv, Kyiv, 04053, Ukraine*

²*Vinnitsia Academy of Continuing Education, 13 Hrushevskoho Str., Vinnitsia, 21050, Ukraine*

³*Vinnitsia Mykhailo Kotsiubynskyi State Pedagogical University, 32 Ostrozhskego Str., Vinnitsia, 21100, Ukraine*

⁴*Institute of Information Technologies and Learning Tools of the NAES of Ukraine, 9 M. Berlynskoho Str., Kyiv, 04060, Ukraine*

⁵*Pavlo Tychyna Uman State Pedagogical University, 2 Sadova Str., Uman, 20300, Ukraine*

Abstract

The article studies the results of the research aimed at the improvement of the methodology of development of the health-preserving competence of a Physical Education teacher in conditions of post-graduate education on the basis of Nikolai Bernstein's theory of movement construction using virtual reality technologies. Based on the use of AR/VR technologies a software application "Virtual Model Illustrating Nikolai Bernstein's Theory of Movement Construction" was developed. The stated model is one of the tools of the "Methodology of development of the health preserving competence of a Physical Education teacher on the basis of Nikolai Bernstein's theory of the levels of movement construction". The experimental study determines that the application of the virtual model within the stated methodology is an effective tool for the development of the health preserving competence of a Physical Education teacher. The application of the virtual model allows the actualization of the health preserving, conceptual, gnoseological, biomechanical, inclusive, corrective potentials of Nikolai Bernstein's theory of movement construction. The use of the virtual model presents the ways of targeted and meaningful use of Nikolai Bernstein's theory of the levels of movement construction by a Physical Education teacher and the improvement of physical and recreational technologies and concrete physical exercises and movement modes. Due to the application of virtual reality tools, health-preserving, preventative, corrective and developmental strategies are being formed among which the significant ones are: "Application of synergistic movements to adaptation to movement activity, and recreation", "Application of spatial movements for actualization of the orientation and search activities and development of spatial thinking", "Use of movements with a complicated algorithm for intellect development".

Keywords

health-preserving competence, Physical Education teacher, post-graduate education, virtual reality, N. Bernstein, biomechanics, methodology, pedagogy of health

1. Introduction

The application of digital technologies in education is a priority vector of innovative development, which gives the chance to disclose the potential of a personality and education [1, 2]. Burov et al. [1], Semerikov et al. [2] speak of the significance of digital technologies for education, "...integration of virtual reality technologies into the educational process would facilitate the increase of the quality of education". These scientists note that this would facilitate the achievement of the "flexibility of the educational process". The stated scientists emphasize that the use of modern digital technologies in the field of education can be viewed as an opportunity for improving education accessibility for children with disabilities as well as children with special educational needs [3, 4, 5]. An important idea of these authors is that "the described technologies will allow to minimize the link of the educational process to a certain place or time as well as enable the access to educational resources in a form that would suit the learner..." [1].

The stated digital technologies are significant for the development of a health preserving competence of a Physical Education teacher in conditions of post-graduate education [6, 7]. This is caused by the need of an educator to perceive a person in conditions of movement activity at a qualitatively new level. The demand for such a perception, apart from health preservation, is the importance for prevention of various disorders as well as the need in the improvement of the skills of a Physical Education teacher related to working with the movement sphere of a person [8]. We actualize the need to use digital technologies, particularly, of virtual reality technologies, to increase the qualification level of a Physical Education teacher in conditions of post-graduate education, first of all, for the study of complicated movements spatial and anthropological phenomena and theories, which they disclose.

Movement as a manifestation of human nature and a way of existence, personality formation and development and its corporality in the professional activity of a Physical Education teacher is a central phenomenon that he or she works with. Therefore, a person's health is also perceived and interpreted in the format of movement activity [8]. At the same time, the nature of movement activity, which includes the knowledge and the practically oriented perception of its in-depth, neurological and systemic mechanisms is currently not fully understood by a Physical Education teacher. Consequently, the knowledge about movement as the essence of human existence is not fully used in the professional activity, primarily, within the health preserving aspect. The insufficient understanding of the in-depth and systemic physiological, neuro-physiological and psychophysiological mechanisms of movement activity by a Physical

AREdu 2021: 4th International Workshop on Augmented Reality in Education, May 11, 2021, Kryvyi Rih, Ukraine

✉ bruney333@yahoo.com (V.M. Fedorets); klochkoob@gmail.com (O.V. Klochko); shyshkina@iitlt.gov.ua

(M.P. Shyshkina); alladobruden@gmail.com (A.V. Dobryden)

🌐 http://esu.com.ua/search_articles.php?id=17432 (M.B. Yevtuch);

<https://scholar.google.com/citations?user=sfjR5w0AAAAJ> (V.M. Fedorets);

<https://sites.google.com/view/klochko-oksana-v> (O.V. Klochko);

<https://iitlt.gov.ua/eng/structure/departments/cloud/detail.php?ID=269> (M.P. Shyshkina);

<http://irbis-nbuv.gov.ua/ASUA/0038843> (A.V. Dobryden)

🆔 0000-0001-6116-4760 (M.B. Yevtuch); 0000-0001-9936-3458 (V.M. Fedorets); 0000-0002-6505-9455 (O.V. Klochko);

0000-0001-5569-2700 (M.P. Shyshkina); 0000-0002-6505-9455 (A.V. Dobryden)

© 2021 Copyright for this paper by its authors.

Use permitted under Creative Commons License Attribution 4.0 International (CC BY 4.0).

 CEUR Workshop Proceedings (CEUR-WS.org)

Education teacher is caused by a number of factors. Among the above mentioned factors, the following main ones can be singled out: the complexity and specificity of the issue; the insufficient understanding of its practical and technological significance; the need to study the neurological foundation of movement; domination of practical and technological training without proper consideration of the knowledge about the nature of movement; underestimation of the importance of the theoretical knowledge about the nature of movement for a professional and thus its insufficient operationalization (in the sense of transformation of theoretical concepts into practices and technologies) as well as targeted use in health preserving technologies and practices of physical education. The stated vector, which discloses the nature of movement activity, is primarily, even though incompletely, studied within the framework of formation and development of the professional competence.

In Ukraine, an important factor of insufficient actualization of knowledge about the nature of movement activity, were the limitations to studying biomechanics, which existed in the former Soviet Union. In the former Soviet Union, the foundations of biomechanics as a science that discloses the nature of movement were made by an outstanding scientist Nikolai Bernstein [8, 9, 10, 11, 12, 13, 14, 15] at the end of 1940-s. One of the focal points of biomechanics is the theory of the levels of movement construction developed by Nikolai Bernstein. In the 1950-s, Nikolai Bernstein and his movement theory were severely criticized and essentially forbidden, and the scientist was persecuted [8, 13, 15] because of the fact that sociocultural processes, including the educational ones, are somewhat inert, biomechanics as a science that discloses the nature of movement and is even currently insufficiently used in the training a Physical Education teacher and development of his health preserving competence. Accordingly, this also applies to the issues of insufficient application of biomechanics, namely, Nikolai Bernstein's classic theory of movement construction in the course of post graduate training of Physical Education teachers.

The current processes of European orientation and humanization of the Ukrainian education as well as the active use of the child-centric, inclusive [16, 17], competence based and innovative approaches, determine the new intellectualized and humane format of Physical Education [8, 18, 19, 20, 21, 22] as a diverse creative anthropological practice and as a variant of a "technology of self", improvement of both the movement sphere and corporality as well as self-realization and personal development and creativity. In this aspect the application of a personality-oriented approach is relevant as it includes the need to consider the personal and age biomechanical peculiarities of a child. One of the main aspects in setting this problem is the introduction of inclusive education. The inclusive paradigm determines the need for a Physical Education teacher to develop intellectual skills of taking into consideration the sensor and motor capabilities of children with special educational needs. Accordingly, in this aspect it is important that an educator gains knowledge and skills that make it possible to correct the sensor and motor disorders with Physical Education [16, 17].

The above mentioned tendencies determine professionalization and a central vector in post-graduate training of a teacher. This creates a need for a practice oriented disclosure of the nature of movement, both in the state of norm and pathology caused by certain motor disorders. An important aspect of actualization of the stated problem is also the issue of primary diagnostics of the state of the motor system, which includes the teacher's understanding of the peculiarities of its neurological foundations in order to personalize and optimize the motion activity at Physical

Education lessons [8]. Diagnosing of the peculiarities and the state of the motor system, based on the knowledge about its nature is significant for health preservation as it allows the teacher to design and organize movement activities of the pupils using a targeted, conceptual and nature corresponding approach as well as correct those activities in the course of the classes. In conditions of commercialization and competition it is important for a Physical Education teacher from the point of their professional and social adaptation and self-realization.

The peculiarity of Nikolai Bernstein's theory of the levels of movement construction [8, 9, 10, 11, 12, 14] is its systemic nature and the fact that it is rather difficult for perception as well as practical application. That is why, effective representation tools are needed in order to present this theory in conditions of post-graduate education and with the focus on its practical implementation. The possibility of using the augmented reality technologies is one of such effective tools. Apart from general tendencies towards digitalization of education, the determining reasons for choosing technologies of virtual and augmented reality include the possibility to work with spatial objects, which is important for biomechanics, which studies mostly spatial changes and movement of a human body; another important factor is the time factor – the need to cover complex scientific theories in the context of their practical application within a short period of time, which is always the case in conditions of post-graduate training; another significant factor is the representative and sense-forming potential of augmented and virtual reality.

The scientific pedagogical literature does not sufficiently cover the issue of strengthening the health-preserving competence of a Physical Education teacher in conditions of post-graduate training, using the knowledge about the nature of movement, which is disclosed in Nikolai Bernstein's theory of the levels of movement construction. The studies do not highlight the ways and methods of using virtual reality for a practically oriented representation of the stated theory in the course of post-graduate training of a Physical Education teacher. Together with the health preserving significance of Nikolai Bernstein's theory of the levels of movement construction, which is being disclosed using augmented reality, it is relevant for the development of the professional competence of a Physical Education teacher as well as for working with children with special educational needs. All these factors put together prove this study to be relevant.

Purpose. Improvement of the methodology of development of the health-preserving competence of a Physical Education teacher in conditions of post-graduate training on the basis of Nikolai Bernstein's theory of movement construction using technologies of virtual reality.

2. Selection of methods and diagnostics

The following approaches were used in the study: analysis of the scientific literature; competence based; systemic; morphological-functional; anthropological [23]; biomechanical [8, 9, 10, 12, 14, 20, 21, 22]; ontological, neurophysiological, pathopedagogical (Fedorets et al. [24], Yevtuch et al. [25]); hermeneutic, inclusive [8, 16, 17].

The following concepts were applied: knowledge transfer (Takeuchi and Nonaka [26]) and anthropologization (Ushinskii [27]).

Digital technologies. Digital technologies were used [1, 2, 3, 6, 7]. The study worked with the Internet resources of the technology of virtual reality, namely the software application

“Virtual Model Illustrating Nikolai Bernstein’s Theory of Movement Construction” [28, 29]. The CoSpaces Edu software was used to develop and view the virtual reality software application [29].

Methods of mathematical statistics. Wilcoxon’s T-test [30]. In order to confirm the statistical significance of the difference in the results of solving the control problems of physical education teachers before and after the experiment, we used Wilcoxon’s T-test. The criterion is used to compare the indicators of the same sample in two different conditions. In this case, the “typical” shift is considered to be a shift in the direction of increasing the values of the studied feature.

We formulate hypotheses:

H_0 : The values of the indicators after the experiment exceeds the values of the indicators before the experiment at the level of significance $p < \psi$.

H_1 : The values of indicators after the experiment are less than the values of indicators before the experiment at the level of significance $p < \psi$.

The calculation of the sum of the ranks of “atypical” shifts T_{emp} is carried out according to the formula

$$T_{emp} = \sum_{i=1}^k r_i, \quad (1)$$

where k is a number of atypical shifts, r_i is the ranks of atypical shifts ($i = 1..k$).

T_{cr} is found in the table for a given n (number of indicators) according to the level of significance ψ . ψ is determined in accordance with the problem 0.05 or 0.01, i.e. $p < 0.05$ or $p < 0.01$.

If $T_{emp} \leq T_{cr}$ at the level of significance $p < \psi$, the shift in the “typical” direction in intensity with high probability prevails, we accept hypothesis H_0 . If $T_{emp} > T_{cr}$, with an intensity with high probability is dominated by a shift in the “atypical” direction, we accept hypothesis H_1 at the level of significance $p < \psi$.

Our own methodological concepts. The developed “Virtual Model Illustrating Nikolai Bernstein’s Theory of Movement Construction” is the determining, conceptualizing and system organizing part of the study. The stated virtual model is a part of the “Methodology of development of the health preserving competence of a Physical Education teacher on the basis of Nikolai Bernstein’s theory of the levels of movement construction”. This methodology is formed on the basis of using pedagogical tasks, analysis of movements and movement modes as well as on the study of practically all significant situations, issues and biomechanical and anthropological phenomena in the normal and pathological states. A significant component of the methodology is the implementation of tasks aimed at the development and correlation analysis of physical exercises and movement modes based on the application of N. Bernstein’s theory of movement construction [8, 9, 10, 12, 14, 20, 21, 22]. The important approaches used within the framework of this methodology include problem based learning and flipped learning as well as game-based teaching methods and Socratic (maieutic) methods. The analysis and study of pedagogical, movement and sport experiences and practices of Physical Education teachers seems important.

Within the stated methodology, we use our own methodological technique “Wheels of problems and senses”. This technique represents a broadened and adapted to practical use

“version” of the hermeneutic circle. In the course of its development we used the holistic and systemic approaches as well as ideas of contextual learning. The developed “Virtual Model Illustrating Nikolai Bernstein’s Theory of Movement Construction” [28, 29] was used throughout the stated methodology and represents its “central” and sense-forming component.

Methodology of control over the efficiency of application “Virtual Model Illustrating Nikolai Bernstein’s Theory of Movement Construction” as a part of the methodology. The basis of the control methodology is presented by 10 interrelated questions. The questions are given in the form of a test. A Physical Education teacher needs to choose one correct answer of the four suggested options. This is done to form a systemic and practically oriented understanding of this issue in a teacher as well as to develop his skill of conceptualizing relevant issues of motor activity in a practical way with the focus on health-preservation. Here is the list of the question.

Question:

1. From the list of movements select those in which level A is the leading one.
2. From the list of movements select those in which level B is the leading one.
3. From the list of movements select those in which level C is the leading one.
4. From the list of movements select those in which level D is the leading one.
5. From the list of movements select those in which level E is the leading one.
6. Which movement level (choose from A, B, C, D, E) dominates in dancing or physical exercises that have a relatively complex algorithm or scenario? How can this be used at the lessons of Physical Education from the point of health-preservation and personality development?
7. At which level of movements (choose from A, B, C, D, E) the movements are implemented with minimal energy losses? How can this be used from the point of health-preservation in organization of workout process at Physical Education lessons?
8. Development of which level of movements (choose from A, B, C, D, E) is the basis of praxis? How can this be used at the lessons of Physical Education from the point of health-preservation and personality development?
9. At which movement level (choose from A, B, C, D, E) basic motor disorders are formed in conditions of infantile cerebral paralysis? Is it possible to consciously and arbitrarily influence this level?
10. Which of the levels of movements (choose from A, B, C, D, E) is associated with orientation and search activity, and can be fully realized thanks to the visual analyzer. The formation of which thinking is facilitated by the actualization of this level of movements? How can this be used at the lessons of Physical Education from the point of health-preservation and personality development?

3. Results and discussion

Improving the health-preserving competence of a physical education teacher in the conditions of postgraduate education is a defining and system-organizing educational precondition for the effective preservation of the health and life of children in the conditions of the educational process. Guided by the paradigm of competence approach and the ideas of inclusion, creativity,

child-centeredness and humanization, we define the *health-preserving competence of a physical education teacher* as an integrative professional and personal ability of a teacher aimed at preserving the life and health of students with typical development and special educational needs in the educational process by forming a healthy lifestyle, prevention and correction of disorders; by promoting the formation of children's competence in personal health-preserving, physical activity, corporeality, physical image, personal freedom, as well as the development of socially adapted, harmonious, ecophilic and life-creating personality through the use of physical culture means. A relevant component of improving the health-preserving competence of physical education teachers in postgraduate education is the use of virtual and augmented reality technologies to deepen and expand practical knowledge about motor activity as a manifestation of human nature and as a way to his or her health.

Let us consider the ways and peculiarities of using the virtual model ("Virtual Model Illustrating Nikolai Bernstein's Theory of Movement Construction") as a system organizing model within the "Methodology of development of the health preserving competence of a Physical Education teacher on the basis of Nikolai Bernstein's theory of the levels of movement construction". In this methodology, the virtual model is the central and sense-forming element, representing a spatial image-semiotic system. We formed the stated methodology on the basis of methodological idea of cyclic, repetitive, rhythmic, step-by-step development of knowledge and senses as well as on the "panoramic" and holistic perception of reality. Together with knowledge development, we actualize the formation of corresponding senses, values, intentions, reflections, interpretations and professional health preserving attitudes. Cyclicity and repetitiveness, being the determining structural and didactic ideas of knowledge representation and sense shaping, are initially defined by systemic nature and a "multi-dimensional" and diverse specifics of N. Bernstein's theory of movement construction [9, 12, 14]. Within the framework of this theory five levels of movements are defined – A, B, C, D, E. Being interrelated and interdependent, these levels represent a complex hierarchic system. It is relevant that every level of motor activity is relatively autonomous and specific and may be considered as a determining and defining for movements that are characterized by common features. At the same time, a certain level is presented as a necessary component or the basis for the next, "higher" level of movements. According to the above described understanding, movements activity may be presented either by all levels or by one, two (e.g. balancing movements), three (e.g. walking) or more (up to five) levels.

Highlighting the essence of N. Bernstein's theory, we characterize each level of movements in the relation to other levels and thus disclose the phenomenology of movements activity as a whole. At the same time, we highlight one key determining aspect (vector) and a few additional ones. These additional aspects facilitate a deeper, widened and interpretation oriented disclosure of the key aspect by supplementing its senses. In this pedagogical system the key aspects (vectors) are presented as *problem-conceptual lines*. These lines differ from the aspects (in a narrow sense) as they are clearly directed, aimed at problem setting, interpretation and constructing of new knowledge. The orientation towards knowledge and sense construction, transfer and transformation includes the actualization of an individual problem as well as the formation of complex and general understandings about movement perceiving the peculiarities of all five levels. Thus, the consideration of the issue of movements activity is being actualized through its consideration within the "individual-general" system, which is one of the central

correlations in hermeneutics [31]. The stated “individual-general” correlation is reflected in the concept of a hermeneutic circle. In our pedagogical system of didactic positions, the central and main differences between the problem-conceptual line and aspect lie in the fact that it is primarily viewed and formed as a certain epistemological, hermeneutic, value-conceptual and practically and technologically oriented subsystem with the corresponding orientations. The consideration of a certain problem-conceptual line (aspect) discloses the nature of all five levels of movement as a complex system and accentuates each of these levels as a particular “movement ontology”. By actualizing each next aspect as the previous one we “take it through” all A, B, C, D, E levels.

For instance, while disclosing the nature of movement through the representation of “Key manifestations of movement” and “Movement characteristics”, we analyze and illustrate it with the help of a virtual model. The movement is structured into subsystems represented by a certain level: A (tonic movements) – ensures muscle tonus, mimic movements, trembling from cold and stress, etc. (see figure 1); B (synergistic movements) – synergistic, economic, balancing, reciprocal (movements in which antagonist muscles contract and relax in turn), smooth, “round” movements etc. (e.g. body movements when a person stands, balances or does physical exercises without lifting the legs from the surface or changing his or her position) (see figure 2); C (level of spatial movements) – movements that ensure active spatial movements: jumps, walking, running, thrusts (see figure 3); D (level of concrete actions) – movements that ensure an effective and targeted work with objects, tools – praxis (see figure 4); E – intellectual movements: language movements and dances and “motion scenarios”, which have a complicated structure (see figure 5).

We briefly represent another important problem-conceptual line, which is a group of inter-related aspects – “Movement as a manifestation of existence, movement as a body scheme, movement as a spatial and orientation phenomenon”. Level A – level of tone – is a manifestation of existence as a given; is “discloses” the space of the body as a self-sufficient, self-referential and self-reflective system; the level of tone (A) essentially “forms” the “vital body” as a self-referential phenomenon both in the consciousness and in reality; this level ensures the formation of a “primary” scheme of the body; discloses the corporal “self” as the one that is in the body in general, actualizes it; existential of corporality; forms a certain orientation within one’s body, which is relatively independent from the environment. Level B – level of synergy – swaying, synergistic movements form: movement as such, which is characteristic of a body and the movement of body parts relatively to the body as well as swaying shifts (sways, bends etc.) of a body in space; discloses the corporal “self” as such exists in the body through synergistic movements; actualized the existential of space [32], the existential of corporality as the existential of movement [8] by shifting parts of the body (limbs and the body itself) relatively to it; discloses the existential of temporality through movements, which are repetitive and periodical, forming a “temporal-biochemical-swaying” process, which facilitates the perception of time; forms orientation within one’s body with regard to and depending on the movement of parts of the body (arms, legs) relatively to it and while making swaying movements, also taking gravitation into consideration; balancing movements give the realization of gravitation and thus form a close connection with the Earth as a planet and the foundation of life; these movements are a precondition for forming spatial metaphors, which represent the basis of the sensor-motoric thinking. Level of spatial movements – C: represents and “unveils” the space, landscape and the

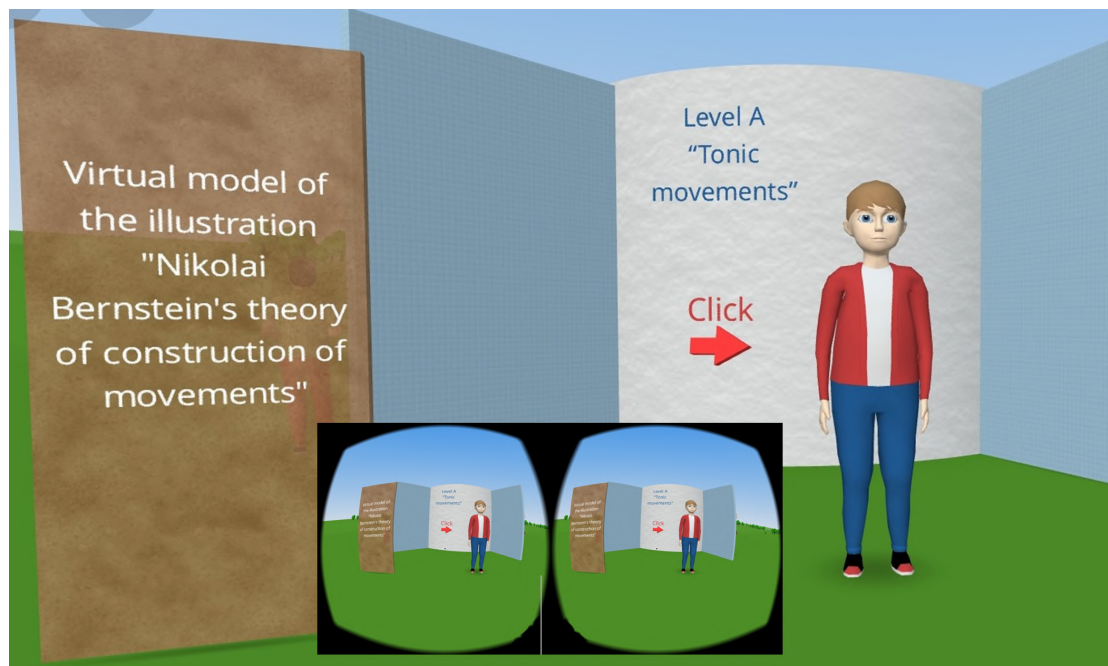

Figure 1: Level A – Tonic movements [28]. The figure shows a man standing. This is provided by the tonic level (A). A person can jump sharply. This is an example of changes in the tonic level – ballism. Movement: muscle tone, statotonic, coordination-tonic, facial expressions, trembling in the cold, grouping when falling. Level basis (is the “background level”) – B, C, D, E. Characteristic of movement: unconscious (automatic), the involvement of all muscles of the body, basic and background for all levels, associated with the subconscious. Attitude to space and orientation: own body.

Earth with the existing objects and perspectives; presents movement as a “spatial” existence through spatial movement; discloses the existential of spatiality and temporality; actualizes the existential of corporality and the existential of locomotion [8] through movement of the body in space; forms an orientation and goal setting in space; is a precondition of forming spatial metaphors as the basis of thinking and values [33]. Level of concrete actions – D; “forms” a “world of things” in the consciousness (the object domain); discloses the orientation within the objects and actions; “creates” praxis as an ability for targeted, creative and “transformational” work with objects, tools and the environment and to a certain extent as a “specific” interaction with people and animate objects (plants, animals). Level of intellectual movements – E: forms mental and corporal activity as a semiotic-conceptual and intentionally-targeted, in the formats of language and communication; discloses the language and dialogue as existence and a mental-communicative way of existing in it; determines the spaces and fields of concepts, senses and values; discloses intellectual activity as a human way of being; actualizes the existentials of love and health as a manifestation of human nature.

The presented brief overview of the three problem-conceptual lines (aspects) in the learning process discloses with the help of the “Virtual Model Illustrating Nikolai Bernstein’s Theory of Movement Construction” the essence of movements activity in a consecutive, “layer-by-layer”,



Figure 2: Level B – Synergistic movements [28]. Movement: base walking and dancing (rhythmic), maintaining balance and balancing, facial expressions. Level basis (is the “background level”) – C, D, E; rhythm of speech and intonation. Characteristic of movement: movements without taking into account the spatial structure of the environment, economical, balancing, stereotic, equilibrium, “pulsating”, rhythmic, repetitive, smooth and precise, partially automatic, the basis of walking, may be partially automatic and unconscious. Attitude to space and orientation: own body and the immediate surrounding space.

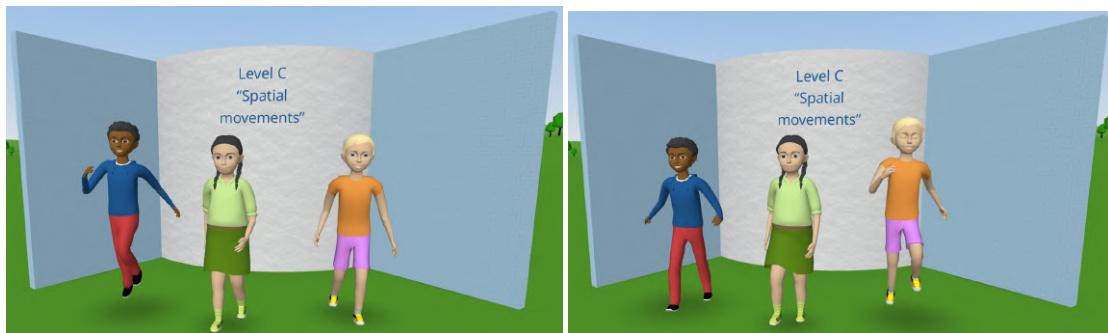

Figure 3: Level C – Spatial movements [28]. Movement: movement based on orientation in space, walking, running, throwing, jumping. Level basis (is the “background level”) – level D, E. Characteristic of movement: spatially oriented, differentiated, precise, conscious, conscious movements. Attitude to space and orientation: three-dimensional space.

cyclic way. In the course of this process the knowledge from various fields (knowledge transfer) is used, which is then naturally integrates into a certain epistemological system. Such a variety of knowledge facilitates the actualization of the hermeneutic potential of N. Bernstein’s theory, which accordingly launches the active formation of interpretations, reflections, understandings and senses. From the didactic point of view, the stated methodology of knowledge representation and perception allows to present the knowledge in various ways, not being limited to a fixed hierarchic model. Problem-conceptual lines may be represented in any order and combination. This creates a corresponding learning diversity, facilitates spontaneous manifestations and is a precondition for creativity and active dialogue-based interaction. Physical Education teachers can independently choose the aspect that needs to be analyzed in the context of N. Bernstein’s theory. This may further be used for a formal description of the methodology for

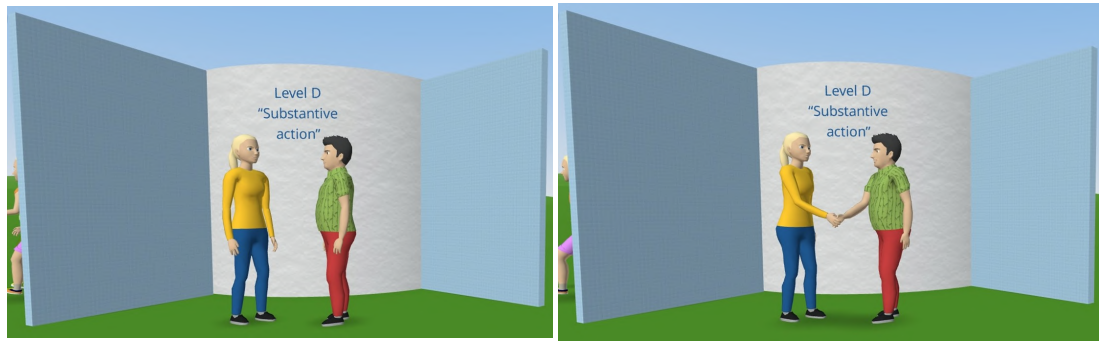

Figure 4: Level D – Substantive action [28]. The figure shows the idea of movement of level D – Substantive action. It is primarily formed through contact in the “man–man” system as a contact. In this case, the participation of level A (tonic movements) is relevant – which forms the possibility of contact with another person, and later (in the process of human development) with the object (tool). Movement: actions and work with objects, praxis. Level basis (is the “background level”) – level E. Characteristic of movement: has a complex algorithm, is targeted, subject-manipulative and meaningful, system-forming and meaning-forming factor is the goal and the result is focused on the action with the objects, this level is semantic and objective, conscious movements. Attitude to space and orientation: “space” of objects and tools that are in three-dimensional space.

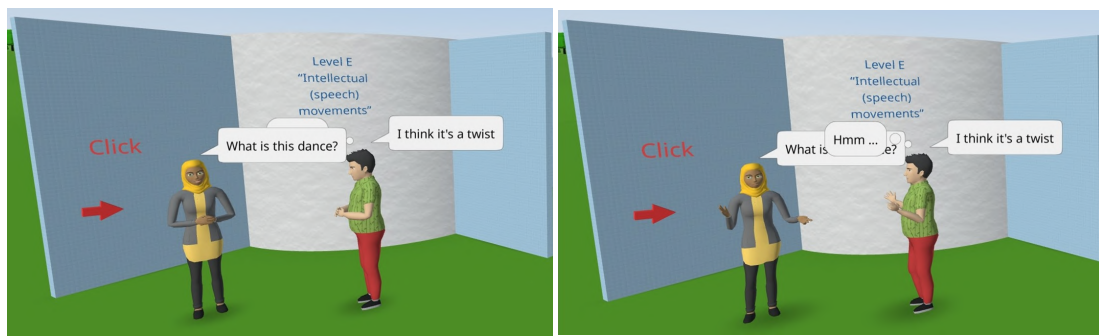

Figure 5: Level E – Intellectual (speech) movements [28]. Movement: intellectualized movements – sign language and partly body language and dance (understood as complex choreographic actions), reading, spoken and written language and reading. Characteristic of movement: characteristics related to speech, physical communication, complex dances and motor scenarios, conscious. Attitude to space and orientation: for language – space of objects and ideas, ideal (virtual) spaces of values, values; for dances and complex motor scenarios – three-dimensional space, space of speech, “space” of tools and objects, space of ideas, values and meanings.

the improvement this virtual reality model of the stated issue and creation of a corresponding interactive model.

Within this pedagogical system we present the repeated and multi-dimensional highlighting of the nature of movement, together with the actualization of its various aspects and with a corresponding subsequent formation of complex understanding of the movements field and a human being, as a methodology (methodological technique) of cyclic and layer-by-layer shaping of knowledge, values and senses, calling it the “Wheel of problems and senses”. The axis idea of

this methodology is the cyclic and repetitive knowledge formation, reproduction, transfer and transformation in various aspects, contexts, formats and in correlation with various problems and aims of movements activity and corporality. This, in turn, determines the hermeneutic and sense forming potentials of the methodology as well as the existence of knowledge in the form of a problem. Accordingly, in the course consideration of various aspects and their analysis in correlation with the nature of various levels of motor activity organization, knowledge is being constantly updated. The very existence of knowledge in the form of problematization, as a problem and as interpretations, facilitates its preservation, development, growth and widens the opportunities for a value based and practical orientation of creativity. Using the ideas expressed by S. Frank, we may characterize such knowledge as “living knowledge” [34]. Thus, thanks to its multi-dimensional, systemic, representative nature, N. Bernstein’s theory allows to disclose the phenomenology of movement using the “Wheel of problems and senses” methodology, which is a practical and targeted application of the idea of a hermeneutic circle and which, speaking metaphorically, forms new knowledge and senses in the course of its “movement” within the “knowledge space”.

The “Virtual Model Illustrating Nikolai Bernstein’s Theory of Movement Construction” forms the foundation of the above presented practical implementation of the ideas of a layer-by-layer and cyclic shaping of knowledge and senses about movement with the help of the “Wheel of problems and senses” methodology (methodological technique). The stated model contains anthropic images, typical situation (e.g. a person is running – level C, or talking – level E) and “motion spaces” in which the peculiarities of every level of movements is being disclosed. The virtual spaces of the stated model as well as the corresponding anthropic images are used to study the peculiarities of various levels of movements and are also subsequently used as sense-forming contexts to highlight and particularize the relevant issues of the motion sphere, health preservation and disclosure of the human phenomenon as a whole.

Thanks to the use of the “Virtual Model Illustrating Nikolai Bernstein’s Theory of Movement Construction”, the “Wheel of problems and senses” and the problem-conceptual lines, which form it to a great extent, motor activity is disclosed as a manifestation of the poly-ontological human nature [35]. Accordingly, the motor activity is represented as a particular “existential-vital-movements-activity-intellectual ontology”, and is not reduced (simplified) to mechanic movements. Motion is viewed as a continuum of anthropological phenomena – from purely “biological-corporal” ones (levels A, B) and “corporal-spatial” (level C) and “corporal-praxeological” to “gnoseological-linguistic” and spiritual ones (level E).

For a “dialogue-based” “immersion” of course participants into the “biomechanical essence of movement”, the initial demonstration of the virtual model includes the actualization of maieutic and interactive practices. The idea of this aspect is to disclose movement as a complex, multi-level anthropic system. In the virtual model, the five levels are demonstrated in the form of anthropic images and are a spatial formation. Such a presentation is essentially a “spatial” as well as “anthropic” metaphorization. It creates the effects and levels of movements are presented using real examples and in real situations, which are considered with the relation to and together with the use of the virtual model.

While focusing the attention of course participants on the phenomena of complexity and consistency as the determining ones in movement construction, we analyze when the stated complexity is distorted by considering the virtual model. Therefore, the fine interaction between

the levels of movements is also distorted. The fact that probable distortions really exist, can be modelled and thus “extracted” from N. Bernstein’s level theory poses a special methodological interest [8, 9, 10, 11, 9, 14]. We suggest that the course participants model probable distortions on the basis of knowledge about the nature of movement disclosed with the help of the virtual model. The stated aspect of decomposition with the subsequent “construction” of movement is possible even after the basic familiarization with N. Bernstein’s theory.

Using the virtual model and, consequently, the “layer-by-layer and periodic consideration”, we present various aspects of movement, each time quickly analyzing the peculiarity of all five levels. In the course of this process, the movements, sport, life and professional experiences of Physical Education teachers are being actualized. As an example, we will consider the problem of sense as a significant component of organizing movements activity by analyzing three levels (A, B, C) of N. Bernstein’s theory.

A – “The level of tone” – reflects the sense of corporal existence. In this aspect we focus on the existentiality of corporality, remembering classical ideas of L. Binswanger [32]. We consider the stated aspect in the spirit of existential pedagogics (Bollnow [36]). Thus, it is significant for the humanization of the educational process and the formation of a kind attitude of a teacher towards a child, which corresponds to the child-centric ideas of the “New Ukrainian School”. While analyzing the “A” level, we indicate that the main “purpose” of a child is the existential perception of self as a possibility and a reality – “I AM” and “BE”.

Senses of the next level B (“Synergistic movements”), which is well represented in the virtual model, is also characterized by human corporality. At the same time, relevant senses of human existence in the environment are added. This level is directly linked with the Earth, namely with gravity. Balancing movements are also included into this level. Thanks to this level, the essential initial contact with the Earth is created. In this aspect, we actualize the ideas of Embodied Cognitive Science within the framework of which the relevant aspect of intellectual activity is the body and human corporality, which are “inscribed” and interact with the environment.

Senses of level C (“Spatial movements”) are primarily disclosed through a possibility to shift the position in space, which is effectively presented in the model. Thus, through the realization of this level, the orientation and search activity, which is one of the preconditions of the intellect and a manifestation of the vitality and spatial nature of a person, is manifested and developed.

The main reason for actualizing the idea of senses of motor activity is for the teacher to understand the ways and possibilities for motivating the pupils to work out and lead a healthy lifestyle. For instance, at level A (tonic movements) the educator works with the senses of corporal being and being as such. This includes beauty, health, the sense of life [8, 32]. This is the “source” of motivation and not the fact that a child “must” workout.

Level B (“Synergistic movements”), just as the previous one, allows a person to understand himself in relation with “himself” and the “environment”, with the Earth. At this level, in order to form senses and influence a pupil, it is necessary to be congruent. In our opinion, this level is linked with a person’s perception of his/her body. To a certain extent, it may be called “corporal reflective”. It discloses the corporality dynamically, in synergistic movements and through rhythms (it is the basis of dances).

At level C (“Spatial movements”), it is important to use the informative-value and vital potential of the “Earth space” in order to form senses and motivations for motor activity and healthy lifestyle. A relevant point is the environmentally friendly application of landscape

pedagogics, spatial metaphors etc.

In the course of implementation of this virtual model, we consider the issue of inclusion (as one of the central problem-conceptual lines) in order to give the teacher an understanding of the ways of improving pedagogical interaction with as well as teaching the children with special educational needs [16, 17], and also to broaden the professional abilities of an educator in terms of correction of sensor-motoric and other disorders with the help of Physical Education tools.

Motor health-preserving strategies are formed on the basis of M. Bernstein's theory of construction of movements. Based on the practical and technological understanding of the features of biomechanics, psychology and neuronal foundations of different levels of movement revealed in M. Bernstein's theory and through the reception of pedagogical and sports experiences of physical education teachers the strategies are developed that are considered as health-preserving and prophylactic ones. The very same strategies are to some extent corrective and developmental. These strategies can be used for health-preserving improvement of existing physical culture and health technologies and practices as well as for the development of new ones. We will briefly present the main aspects of motor health-preserving strategies.

Motor health-preserving strategy "Application of synergistic movements to adaptation to movement activity, and recreation" is developed on the basis of practically oriented understanding of synergistic movements – level B. The feature of these movements is economical, adjusting, pulsating, repetitive, rhythmic, balancing and to some extent "recreational" nature (see figure 2). This strategy can be applied to the formation of new motor actions (in the sense of physical exercises), as well as used in the already existing ones with the actualization of the synergistic component. That is, already known exercises can be performed in a "synergistic mode". Such movements are balancing, rhythmic, repetitive and are realized with a sense of ease. The movements can also be performed partially in an automated mode, which creates the effect of rest, comfort of the movement itself, "comfortable" feeling of your body, as well as calming due to the actualization of the rhythmic component. The application of spatial and body-spatial motor metaphors is relevant, in which there is an orientation in the directions up/down, forward/backward, right/left, the movement around own axis. The application of this "synergistic strategy" is necessary for the "soft entry" into motor activity, which corresponds to human nature i.e. for warming-up and getting out of the load – for a hitch. "Entering" and "exiting" motor activity should be delicate and inconspicuously synchronize the work of the cardiovascular and respiratory systems and musculoskeletal system, taking the body to a qualitatively new level of functioning systematically, smoothly, rhythmically, not abruptly, quickly, "avalanche like" and not synergistically. Synergistic movements also play a setting and tuning role for a particular activity or other movements. Let's remember the soft, delicate, oscillating and rhythmic movements when a woman shakes a baby. In the same semantic series there are synergistic (rhythmic, oscillating) combat or "marriage" (expressed in animal dances) movements, both in humans and in animals that have a corresponding reflection in dances.

The motor health-preserving strategy "Application of spatial movements for actualization of orientation-search activity and development of spatial thinking" is formed on the basis of actualization of orientation-search activity which has expressive spatial character (see figure 3). In the implementation of this activity, visual and auditory analyzers are activated as the main ones that provide adaptation in space. The development and active functioning of the mentioned analyzers (visual, auditory) is a sensory prerequisite for the formation of spatial thinking,

orientation and imagination. To implement this strategy, we recommend using outdoor activities, the potential of landscape pedagogy and tourism, as well as the demonstration of landscapes and spatial objects and their discussion. It is important to use motor games with elements of orientation in space and complex-coordinated movements and movements on various including circular trajectories and their subsequent analysis and discussion. The application of spatial motor metaphors, elements of theatrical pedagogy, which includes reincarnation into various images in which the motor and spatial-motor components are expressive, is relevant.

The motor health-preserving strategy “Application of movements with a complex algorithm for the development of intellect” is formed on the basis of updating the intellectual potential of the level E – intellectual movements) (see figure 5). We recommend using relatively complex motor scenarios, including choreographic and those that can be performed both individually and collectively, as well as to teach to work with spatial images, routes and actions, thinking about their trajectory and method of implementation. An example is the performance of combat movements in martial arts combined into a special system (dance) – kata. The combat motor actions are integrated and transformed into a sequence of movements and a sequence of actions (if movements with objects or weapons) in kata. Motor actions are thus interconnected and “intercurrent” successive combat movements that are integrated into a system. They represent “motor-spatial algorithms” and a system of body-movements “tools” of influence and action. The spatial-temporal integration of motor actions is based on: principles and cultural traditions and experiences of combat, ideas about the enemy and the combat situation, modeling and reflexive understanding of the probable problem, concentration and meditation techniques, knowledge of biomechanics and human psychology. Thus, the kata from the standpoint of cognitivism can be considered as a “body – space – activity” semiotic system defining characteristic, which is cognition. It is interesting to use the representative potential of movements, which includes the ability to communicate through motor activity and demonstrate complex ideas, feelings, which is also considered in the framework of theater pedagogy. The use of music and the arts in general, including poetry, is important. The use of elements of play, carnival, imitation of life scenarios, as well as narrative and communicative skills of a teacher is important for the actualization of this level.

We recommend using augmented and virtual reality technologies in the implementation of all these motor health-preserving strategies, which will allow implementing them at a new quality level.

One of the significant results of contemporary European centric transformations of the Ukrainian education is the formation of intellectualized, axiologized, “human-centric”, psychology driven and “humanitized” physical culture [18, 22]. Such physical culture is considered as a relevant component of movements activity, development and existence of a child and not only as a school subject. Thus, it is represented as a system of personality-oriented and culture-corresponding techniques of the body, which we view in correlation with mental, spiritual and health preserving practices as well as, to a certain extent, their inseparable components. Judging from the anthropological-cultural and humanistic positions, it is important that the teacher perceives the cultural heritage and includes it into the value-conceptual contexts of the educational process, namely, for the organization of motor activity, development of corporality and the corporal image of the pupils.

In the light of such views, physical culture may be viewed not only as a corporal technique

and a motion practice of a particular culture, but first and foremost as a culture forming unit. We believe that corporal techniques make up the basis of preserving physical as well as psychological, existential and spiritual health.

N. Bernstein [8, 9, 10, 13, 14, 15] defined a person and his/her locomotor sphere as a set of super complex integratively functioning intentional systems, which have a certain potential for autonomy (in a modern auto-poetic understanding). This made his views radically different from the views of a simple person (lat. *Homo simplex*) and a reflex person, mechanic person, automated person. N. Bernstein's ideas are disclosed and have undergone value based comprehension with the help of virtual reality and they lead us to an idea that movement is a manifestation of the higher nature of human existence as well as to an understanding of metaphysical and ontological for mans of motor activity.

An experimental study. To analyze the efficiency of using the "Virtual Model Illustrating Nikolai Bernstein's Theory of Movement Construction" within the "Methodology of development of the health preserving competence of a Physical Education teacher on the basis of Nikolai Bernstein's theory of the levels of movement construction" in the Communal Higher Educational Institution "Vinnytsia Academy of Continuous Education" and study was conducted in 2019 among 165 Physical Education teachers, who were taking the professional growth training course. The experimental group was made up of 85 people.

Let us prove the statistical confidentiality of the obtained results. The number of tasks that had to be completed by the Physical Education teachers before and after the The results showing the number of correct answers of Physical Education teachers to the question before and after using the methodology of development of health-preserving competence of a physical education teacher in the conditions of postgraduate education on the basis of N. Bernstein's theory of construction of movements with the use of virtual reality technologies $n_1 = 10$ and $n_2 = 10$ (see figure 6).

Let us confirm the statistical significance of exceeding the values of the indicators of the results of solving control problems by physical education teachers after the experiment over the values of the corresponding indicators before the experiment using the Wilcoxon's T-test [30].

We find the difference between the values of the corresponding indicators of the results of solving control tasks by physical education teachers before and after the experiment (table 1).

We arrange the obtained absolute values of the differences in the indicators of the studied trait before and after the experiment in ascending order. Rank them in ascending order of absolute differences with using average ranks (because there are related ranks) from 1 to 10 (table 1).

Analysis of the table data showed that there are no "atypical" shifts. So, calculated by formula (1)

$$T_{emp} = \sum_{i=1}^k r_i = 0.$$

Find the critical value for the Wilcoxon's T-test for $n = 10$, using the data in table 1:

for $p < 0,05$ the $T_{cr} = 10$,

for $p < 0,01$ the $T_{cr} = 5$.

The empirical value $T_{emp} = 0 < T_{cr} = 5$ at the significance level $p < 0.01$.

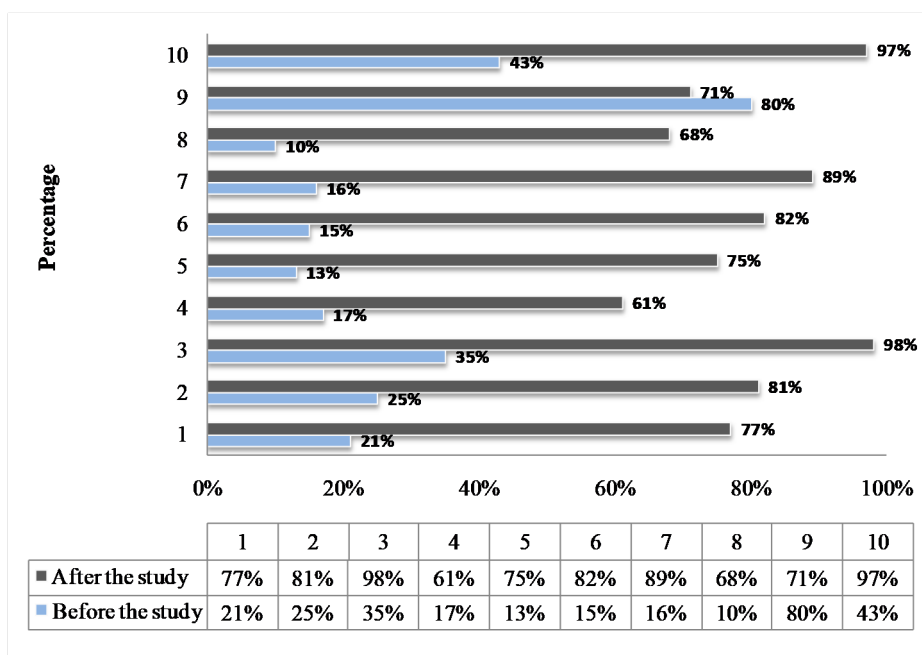

Figure 6: The results showing the number of correct answers of Physical Education teachers to the question before and after using the methodology of development of health-preserving competence of a physical education teacher in the conditions of postgraduate education on the basis of N. Bernstein’s theory of construction of movements with the use of virtual reality technologies.

Hypothesis H_0 is accepted. The values of the indicators of the results of solving control tasks by physical education teachers after the experiment statistically with a high probability exceed the values of the indicators before the experiment at the level of significance $p < 0.01$.

3.1. Conclusion

The application of virtual reality technologies for health and practically oriented perception of the phenomenology of movement activity, the essence of which is disclosed in Nikolai Bernstein’s theory of movement construction, is an important innovative tool for improvement of the health preserving competence of a Physical Education teacher in conditions of postgraduate education. Based on the use of AR/VR technologies a software application “Virtual Model Illustrating Nikolai Bernstein’s Theory of Movement Construction” was developed. This virtual model is an effective tool for the development of the stated competence.

The results of the analysis of the research aimed at the study of the efficiency of the virtual model within the “Methodology of development of the health-preserving competence of a Physical Education teacher on the basis of Nikolai Bernstein’s theory of the levels of movement construction” using the Wilcoxon’s T-test prove the statistical significance of the efficiency of application of the given methodology, namely, a statistically viable positive dynamics of the educational achievements of Physical Education teachers have been determined. With the help of the virtual model the health-preserving, intellectual, gnoseological, hermeneutic,

Table 1

The value of the corresponding indicators of the results of solving control tasks by physical education teachers before and after the experiment, their difference and ranks of absolute values of differences

Order number of the task, n	Before the experiment, x_{before} (%)	After the experiment, x_{after} (%)	Difference, $x_{after} - x_{before}$ (%)	The absolute value of difference (%), $ x_{after} - x_{before} $	Ranks of absolute values of differences, r_i
1	21	77	56	56	3.5
2	25	81	56	56	3.5
3	35	98	63	63	7.5
4	17	61	44	44	1
5	13	75	62	62	6
6	15	82	67	67	9
7	16	89	73	73	10
8	10	68	58	58	5
9	8	71	63	63	7,5
10	43	97	54	54	2
Sum total	-	-	-	-	55

representative, axiological, praxeological, technological and sense forming potentials of Nikolai Bernstein's theory are being disclosed. This facilitates the formation in a teacher of systemic views and structural-functional, holistic and value-conceptual understandings of movement as the basis of life and health as well as the "existential-vital-movement-activity-intellectual ontology".

Disclosing the theory of movement construction through the application of the virtual model and other tools as viewed as a gnoseological precondition of fundamentalization of the health-preserving knowledge and the corresponding competence and it is also a cognitive factor of the health-preserving oriented professionalization and axiologization of the work of a Physical Education teacher. The use of a virtual model for the representation of Nikolai Bernstein's theory in the methodology of the health-preserving competence of Physical Education teachers is a necessary condition for the development of the stated competence both in the context of its integration with the professional competence as well as to raise the scientific, fundamental and technological level. This also facilitates the effective practically oriented application of the state theory by a Physical Education teacher for the analysis and improvement of physical and recreational technologies as well as of concrete physical exercises and movement modes.

Accordingly, a Physical Education teacher gains professional opportunities for the application of Nikolai Bernstein's theory in the health preserving and correction-development work with children with special educational needs as well as in inclusive education practices. On the basis of the health-preservation oriented disclosure of the nature of movement, health-preserving, preventative, corrective and developmental strategies are being formed among which the significant ones are: "Application of synergistic movements to adaptation to movement activity, and recreation", "Application of spatial movements for actualization of the orientation and search activities and development of spatial thinking", "Use of movements with a complicated

algorithm for intellect development”.

References

- [1] O. Burov, A. Kiv, S. Semerikov, A. Striuk, M. Striuk, L. Kolgatina, I. Oliinyk, AREdu 2020 - How augmented reality helps during the coronavirus pandemic, CEUR Workshop Proceedings 2731 (2020) 1–46.
- [2] S. Semerikov, I. Teplytskyi, Y. Yechkalo, A. Kiv, Computer simulation of neural networks using spreadsheets: The dawn of the age of Camelot, CEUR Workshop Proceedings 2257 (2018) 122–147. URL: <http://ceur-ws.org/Vol-2257/paper14.pdf>.
- [3] V. Osadchyi, H. Varina, K. Osadcha, O. Prokofieva, O. Kovalova, A. Kiv, Features of implementation of modern ar technologies in the process of psychological and pedagogical support of children with autism spectrum disorders, CEUR Workshop Proceedings 2731 (2020) 263–282.
- [4] I. Tatianchykova, O. Kovshar, S. Boiko, Impact of psycho-pedagogical assistance in the development of socialization skills for children during integration in special schools, Universal Journal of Educational Research 8 (2020) 3387–3391. doi:10.13189/ujer.2020.080811.
- [5] T. Kramarenko, K. Bondar, O. Shestopalova, The ICT usage in teaching mathematics to students with special educational needs, Journal of Physics: Conference Series 1840 (2021) 012009. doi:10.1088/1742-6596/1840/1/012009.
- [6] O. Klochko, V. Fedorets, A. Uchitel, V. Hnatyuk, Methodological aspects of using augmented reality for improvement of the health preserving competence of a physical education teacher, CEUR Workshop Proceedings 2731 (2020) 108–128.
- [7] O. Klochko, V. Fedorets, O. Maliar, V. Hnatyuk, The use of digital models of hemodynamics for the development of the 21st century skills as a components of healthcare competence of the physical education teacher, E3S Web of Conferences 166 (2020) 10033. doi:10.1051/e3sconf/202016610033.
- [8] V. M. Fedorets, Development of the Health Preserving Competence of a Physical Education Teacher on the Basis of Methodological Value Reflection and Methodic Perception of Mykola Oleksandrovykh Bernstein’s theory of level movement organization, Original, Kharkiv, 2018, pp. 590–620.
- [9] N. A. Bernstein, Fiziologiya dvizheniy i aktivnost (Physiology of movements and activity), Nauka, Moskva, 1990.
- [10] D. M. Devishvili, N. A. Bernshteyn – osnovatel sovremennoy biomekhaniki (N. A. Bernstein - the founder of modern biomechanics), Natsionalnyy psikhologicheskiy zhurnal 4 (2015) 74–78.
- [11] L. P. Latash, M. L. Latash, A New Book by N. A. Bernstein: “On Dexterity and Its Development”, Journal of Motor Behavior 26 (1994) 56–62. doi:10.1080/00222895.1994.9941662.
- [12] N. A. Bernstein, Biomechanics for Instructors, Springer, 2020.
- [13] V. L. Talis, New Pages in the Biography of Nikolai Alexandrovich Bernstein, Springer International Publishing, Cham, 2015, pp. 313–327. doi:10.1007/978-3-319-19446-2_18.

- [14] R. Bongaardt, O. G. Meijer, Bernstein's theory of movement behavior: Historical development and contemporary relevance, *Journal of Motor Behavior* 32 (2000) 57–71. doi:10.1080/00222890009601360.
- [15] O. G. Meijer, S. M. Bruijn, The loyal dissident: N. A. Bernstein and the double-edged sword of Stalinism, *Journal of the History of the Neurosciences* 16 (2007) 206–224. doi:10.1080/09647040600720979.
- [16] I. S. Perkhurova, *Regulyatsiya pozy i khotby pri detskom tserebralnom paraliche i nekotoryye sposoby korrektsii* (Regulation of posture and walking in infantile cerebral palsy and some methods of correction), Knizhnaya palata, Moskva, 1996.
- [17] N. Stepanchenko, I. Hrybovska, M. Danylevych, R. Hryboskyy, Aspects of psychomotor development of primary school children with hearing loss from the standpoint of Bernstein's theory of movement construction, *Pedagogy of Physical Culture and Sports* 24 (2020) 151–156. URL: <https://sportpedagogy.org.ua/index.php/ppcs/article/view/1341>. doi:10.15561/26649837.2020.0308.
- [18] O. Aksonova, *Nova fizychna kultura abo shkola rozumnoho rukhu* (New physical culture or school of intelligent movement), *Teoriia ta metodyka fizychnoho vykhovannia* 12 (2010) 29–34.
- [19] I. M. Bykhovskaya, "Chelovek telesnyy" v sotsiokulturnom prostranstve i vremeni : (Ocherki sotsialnoy i kulturnoy antropologii) ("Bodily man" in socio-cultural space and time: (essays on social and cultural anthropology)), *Fizkultura, obrazovaniye i nauka*, Moskva, 1997.
- [20] S. V. Dmitriyev, *Alternativnaya biomekhanika "zhivyykh dvizheniy" v sfere sporta i adaptivnoy fizicheskoy kultury* (Alternative biomechanics of "live movements" in the field of sports and adaptive physical culture), *Visnik Chernigivskogo natsionalnogo pedagogichnogo universitetu. Seriya: Pedagogichni nauki* 18 (2014) 10–14.
- [21] D. D. Donskoy, S. V. Dmitriyev, *Psikhosemanticheskiye mekhanizmy upravleniya dvigatelnyimi deystviyami cheloveka* (Psychosemantic mechanisms of human motor actions control), *Teoriya i praktika icheskoj kultury* 9 (1999) 2–6.
- [22] N. N. Efimenko, *Nauchnoye naslediyе N. A. Bernshteyna v svete sovremennykh problem korrektsionnogo fizicheskogo vospitaniya detey s narusheniyami oporno-dvigatel'nogo aparata* (Scientific heritage of N. A. Bernshtein in the light of modern problems of correctional physical education of children with musculoskeletal disorders), *Naukoviy chasopis natsionalnogo pedagogichnogo universitetu im. M. P. Dragomanova* 19 (2011) 68–73.
- [23] A. S. Tkhostov, *Psikhologiya telesnosti* (Psychology of corporality), Smysl, Moskva, 2002.
- [24] V. M. Fedorets, M. B. Yevtuch, O. V. Klochko, N. P. Kravets, R. S. Grynyov, Development of the health-preserving competence of a physical education teacher based on the knowledge about influenza and bronchitis prevention, *SHS Web of Conferences* 104 (2021) 02006. doi:10.1051/shsconf/202110402006.
- [25] M. B. Yevtuch, V. M. Fedorets, O. V. Klochko, N. P. Kravets, T. R. Branitska, Ecological and axiological reflection of the concept of sustainable development as a basis for the health-preserving competence of a physical education teacher, *SHS Web of Conferences* 104 (2021) 02008. doi:10.1051/shsconf/202110402008.
- [26] H. Takeuchi, I. Nonaka, *Hitotsubashi on knowledge management*, Wiley, 2004.
- [27] K. Ushinskii, *Chelovek kak predmet vospitaniia. Opyt pedagogicheskoi antropologii*

- (Man as a subject of education. An attempt at pedagogical anthropology), volume 8, Izdatelstvo Akademii pedagogicheskikh nauk RSFSR, Moscow, Leningrad, 1950. URL: https://imwerden.de/pdf/ushinsky_sobranie_sochineny_tom08_1950_text.pdf.
- [28] CoSpaces Edu, Fedorets VM, Klochko OV: Model of Identifying the Risks for Muscular-Skeletal Apparatus Caused by Ligament Strain 1, 2021. URL: <https://edu.cospaces.io/HCC-WNR>.
- [29] CoSpaces Edu, Make AR & VR in the classroom, 2021. URL: <https://cospaces.io/edu/>.
- [30] E. D. Sidorenko, Methods of mathematical processing in psychology, Rech, 2003.
- [31] W. Dilthey, Wilhelm Dilthey: Selected Works, Volume IV: Hermeneutics and the Study of History, Princeton University Press, 1996. URL: <http://www.jstor.org/stable/j.ctv39x6db>.
- [32] S. Besoli, On the Emergence of Thymic Space in Ludwig Binswanger, Springer International Publishing, Cham, 2017, pp. 35–55. doi:10.1007/978-3-319-66911-3_3.
- [33] G. Lakoff, M. Johnson, Metaphors we live by, University of Chicago Press, Chicago, 1980.
- [34] S. L. Frank, Predmet znaniya (Subject of knowledge), Directmedia, 2016.
- [35] N. A. Nosov, Virtual'naya real'nost': Filosofskie i psihologicheskie aspekty (Virtual reality: Philosophical and psychological aspects), Voprosy filosofii 10 (1999) 152–154.
- [36] O. F. Bollnow, Neue Geborgenheit: Das Problem einer Überwindung des Existentialismus, Kohlhammer Stuttgart, 1955.

The usage of augmented reality technologies in professional training of future teachers of Ukrainian language and literature

Olha B. Petrovych¹, Alla P. Vinnichuk¹, Viktor P. Krupka¹, Iryna A. Zelenenka¹ and Andrei V. Voznyak²

¹*Vinnitsia Mykhailo Kotsiubynskyi State Pedagogical University, 32 Ostrozhskogo Str., Vinnitsia, 21100, Ukraine*

²*Kryvyi Rih State Pedagogical University, 54 Gagarin Ave., Kryvyi Rih, 50086, Ukraine*

Abstract

The article deals with the peculiarities of creation and practical application of augmented reality (AR) technologies for the organization of students-philologists' individual and group work in studying the discipline "Methodic of teaching literature". The relevance of the introduction of AR technologies for the future teachers-philologists' readiness formation to the professional activity is substantiated. Analysis of the scientific sources suggested that the professional training process requires the modernization of teaching methods, and the usage of information and communication technologies (ICT) in education, in particular AR technologies, allows to make the learning process interesting and exciting. The domestic and foreign experience of AR technologies application into current educational practices is generalized. A step-by-step algorithm for creating the AR in the mobile application Unite and its subsequent content filling for professional training of future teachers of Ukrainian language and literature is described. The visualization of the educational content of the lepbook "Incredible Lesya Ukrainka", made by students-philologists at the Mykhailo Stelmakh Faculty of Philology and Journalism of Vinnitsia Mykhailo Kotsiubynskyi State Pedagogical University during the studying the discipline "Methodic of teaching literature", is detailed. It is specified that the educational process is based on the creation AR with the visualization of interactive learning materials with animation, instructions, links, video content, illustrations etc. according to the rubrics of the lepbook. It is emphasized that the implementation of AR technologies provides the increasing of motivation for systematic mastering of practical skills, enhances students' concentration and attention, increases their cognitive experience, promotes the development of their creative abilities, produces the opportunities of using the visualized content for students' research work, stimulates them to self-expression, motivates them to self-development, trains them to the skillful use of the Internet, modern gadgets and mobile applications, etc. Prospects for studying the possibilities of using AR technologies in lessons of Ukrainian literature at secondary school are determined.

Keywords

augmented reality technologies, professional training, the future teachers-philologists, mobile applications, visualization, digitalization

1. Introduction

1.1. Problem statement

High-speed information progress of society, the creation of new means of processing, transmission, reception and storage of information cause the new challenges to the educational modernization. Today such ICT as virtual and augmented reality are gaining wide popularity in professional training of future professionals in higher education. The linguistic and literary field is no exception [1]. AR technologies are used in the format of mobile learning and are a powerful tool for improving the digital competence of future teachers of Ukrainian language and literature.

The usage of AR technologies helps to combine physical and digital visualized content to reproduce the effect of maximum reality, adds the appropriate visual information, implements students' interaction with virtual projection in real time. The introduction of AR technologies in the educational process of future teachers-philologists provides the increasing of motivation for systematic mastering of practical skills, enhances students' concentration and attention, increases their cognitive experience, promotes the development of their creative abilities, produces the opportunities of using the visualized content for students' scientific research work.

Thus, AR technologies become more often used in different social activity fields and especially in education. A lot of educational AR applications in biology [2], physics [3], chemistry [4], natural science [5], mathematics [6], history [7] and other subjects have been developed, and even AR books for children have been created [8]. However, the usage of AR technologies in professional training of the future teachers of Ukrainian language and literature still remains unexplored.

1.2. Literature review

Milgram et al. [9] discussed AR displays in a general sense, within the context of a Reality-Virtuality continuum, encompassing a large class of "Mixed Reality" displays, which also includes Augmented Virtuality. According to Milgram and Kishino [10], AR is characterized as a specific innovative technology based on the display of an otherwise real environment is augmented by means of virtual (computer graphic) objects.

Azuma [11] provided a starting point for anyone interested in AR in his survey. He defined

AREdu 2021: 4th International Workshop on Augmented Reality in Education, May 11, 2021, Kryvyi Rih, Ukraine

✉ olha.petrovych@vspu.edu.ua (O. B. Petrovych); alla.vinnichuk@vspu.edu.ua (A. P. Vinnichuk);

viktor.krupka@vspu.edu.ua (V. P. Krupka); iryna.zelenenka@vspu.edu.ua (I. A. Zelenenka);

avvoznyak76@gmail.com (A. V. Voznyak)

🌐 https://library.vspu.edu.ua/inform/nauk_profil.htm#petrovich_olga (O. B. Petrovych);

https://library.vspu.edu.ua/inform/nauk_profil.htm#vinnichuk_alla (A. P. Vinnichuk);

https://library.vspu.edu.ua/inform/nauk_profil.htm#krupka_viktor (V. P. Krupka);

https://library.vspu.edu.ua/inform/nauk_profil.htm#zelenenka_irina (I. A. Zelenenka);

<https://kdpu.edu.ua/personal/avvoznyak.html> (A. V. Voznyak)

🆔 0000-0002-7185-3823 (O. B. Petrovych); 0000-0003-0359-4169 (A. P. Vinnichuk); 0000-0002-2320-8045

(V. P. Krupka); 0000-0002-3031-775X (I. A. Zelenenka); 0000-0003-4683-1136 (A. V. Voznyak)

© 2021 Copyright for this paper by its authors.

Use permitted under Creative Commons License Attribution 4.0 International (CC BY 4.0).



CEUR Workshop Proceedings (CEUR-WS.org)

AR as a variation of Virtual Reality (VR). AR allows the user to see the real world, with virtual objects superimposed upon or composited with the real world. Azuma [11] convinces that AR supplements reality, rather than completely replacing it, because the virtual and real objects coexist in the same space.

Different aspects of the implementation of AR technologies in the educational process attract was studied by Babkin et al. [12], Burov et al. [13], Gargrish et al. [14], Jerabek et al. [15], Kaur et al. [16], Kiv et al. [17], Kolomoiets and Kassim [18], Kramarenko et al. [19], Lavrentieva et al. [20, 21], Nechypurenko et al. [22], Palamar et al. [23], Panchenko et al. [24], Pochtoviuk et al. [25], Rashevskaya and Soloviev [26], Rashevskaya et al. [27], Scaravetti and Doroszewski [28], Shepiliev et al. [29], Semerikov et al. [30], Striuk et al. [31], Tarasenko et al. [32, 1], Tkachuk et al. [33], Tuli and Mantri [34], Vakaliuk and Pochtoviuk [35], Zelinska et al. [36], Zhou et al. [37], Zinonos et al. [38] and others. According to many researchers [39], AR technologies are one of the trends in modern education, which allows to modernize the learning process in the context of digitalization.

A considerable amount of research papers has been investigating the effectiveness of AR in education, aiming to improve traditional methodic of teaching [40, 41, 42]. Ramirez et al. [43] researched the benefits of the use of AR on the area of maintenance and education. They discovered that the transfer of knowledge using AR is faster than the traditional methods, thus AR technologies help to train the specialists faster and better.

The use of AR technologies in the studying of Ukrainian language and literature remains poorly understood. For example, Nezhyva et al. [44] substantiated the prospect of the usage of AR within the linguistic and literary field of primary education. But the usage of AR technologies in the formation of the readiness of future teachers of Ukrainian language and literature to professional activities has not been studied.

Despite the interest of scientists in modernizing teaching methods, the problem of using ICT, in particular AR applications, in formation the readiness of future teachers-philologists for professional activity requires further researches. The analysis of scientific publications proves that the AR applications in the educational process have limited and insufficient use, and the observations of practical implementation show that a small number of teachers use them expediently and effectively in their work. Therefore, in accordance with the needs of modern society in intensifying the use of ICT for educational purposes, it is important to study methodologically and pedagogically appropriate ways of effective training of students-philologists with the help of AR.

1.3. The aim of the research

The aim of the research is to elucidate the peculiarities of the creation and use of the AR technologies in the format of studying the discipline “Methodic of teaching literature” for effective professional training of students-philologists.

2. Discussion and results

2.1. AR technologies in education: the experience described in research papers

According to Scaravetti and Doroszewski [28] with the help of AR the student is in a learning by action position. Thus, the student can be more involved and build his/her knowledge in real life situations. The researchers noticed a strong interest of learners in the use of AR, and the biggest students' interest in AR is to bring the targeted information at the appropriate moment.

Gargrish et al. [14] substantiate their choice AR over VR for the purpose of education as AR provides the learner's interact with real objects aside from immersion and interaction with virtual objects feel. The authors list different devices for experiencing AR, it can be mobile based, desktop based or tabletop environment.

Kesim and Ozarslan [45] describe the combination of AR technology with the educational content as a new type of automated applications that acts to enhance the effectiveness and attractiveness of teaching and learning for students in real life scenarios. The authors note that displaying information by using virtual effects that the learner cannot directly detect with his own senses can enable a person to interact with the real world in ways never before possible. They affirm that the position, shape, and/or other graphical features of virtual objects can be changed with interaction techniques AR supports. The researchers underline that information conveyed by the virtual objects helps students perform real world tasks. One more important statement is that AR textbooks can be used in educational process and become dynamic sources of information [45].

Coimbra et al. [46] highlight the need to implement AR in education because it can encourage motivation, comprehension and a higher involvement with the contents to be learned. Thus, AR technologies may increase the use of information and the access to knowledge, improving digital and info-inclusion. Besides such technologies allow the integration of theoretical knowledge in real contexts and also allow the integration of real contexts in more theoretical ways of presentation [46].

Zhou et al. [37] consider AR as promising potential tools for science teaching and learning processes that could foster positive emotions, motivate autonomous learning, and improve learning outcomes. The researchers note that mobile AR-assisted learning is flexible for students to use pre-class or after-school without being constrained by time and space, it helps students to learn the theoretical aspects of subject. The authors point out that AR can improve learning efficiency and prompt positive emotions. They differentiate AR technologies used in science education into 2 categories: image-based AR and location-based AR. Scholars draw our attention to image-based AR (including marker and markerless technology) which promote to develop the students' spatial abilities, practical skills, and their understanding of concepts through real-time interactive simulation experiments. The authors distinguish AR book as one of the most common image-based AR technologies in education [37].

Jerabek et al. [15] detailed the didactic aspect of AR in such a way that the students find themselves in an environment that is deliberately designed to provide the appropriate conditions to fulfill the educational purpose. The researchers sum up the main educational functions which are basics to all didactic situations with the usage of AR. Firstly, it's the adjusting the degree of

emotional impact of the resulting AR environment, and, secondly, cognitive load adjustment. The authors aver that these functions predetermine the usage of AR in education in many different forms and in various ways to achieve the following five principal educational purposes:

1. Increase in information value.
2. Exposition of temporally and spatially heterogeneous phenomena.
3. Simulation of phenomena, events and processes.
4. Acquisition and building of competencies in model situations.
5. Management activities [15].

Jerabek et al. [15] assure that AR is an innovative didactical tool which contributes to a more effective and better-quality education activities through enhancing the system of didactic tools and their functions and become thus a suitable tool for supporting cognitive processes in various educational fields.

Kaur et al. [16] draw our attention to AR which provide the students with such tools that they are able to visualize and interact with what is taught in the classroom. Thus, their motivation towards learning can be enhanced with the help of AR technologies which, in their turn, have an edge over the traditional styles of teaching and learning in classroom settings.

Bacca et al. [47] mention the special situation in Vocational Education and Training (VET) institutions where teachers face important difficulties in the teaching process due to a wide variety of student's special educational needs as well as student's lack of: the adequate level of basic competence, motivation, concentration, attention, confidence and background knowledge, among other aspects. The authors report positive impact of mobile AR applications in VET for increasing motivation, especially in confidence and satisfaction dimensions. The research has provided insights on how AR can be used to support the three main guidelines of the Universal Design for Learning: a) provide multiple means of presentation b) provide multiple means of expression and c) provide multiple means of engagement. Thus, AR applications can be designed to address special educational needs of students in VET institutions [47].

Several researchers emphasize that AR technologies offer a major opportunity to revolutionize education and to promote student-centered learning [48, 49, 50, 51, 52]. They proclaim AR technologies empower the future of education, because AR helps facilitate the learning process, enhance current online education methods, bridge the gap between formal education and informal learning, and equip educators with novel methods of content delivery.

Nincarean et al. [53] sums up that most of the students (who had never experienced an AR) felt motivated using AR technologies application in their studying, enjoyed the process of scanning and finding virtual effects in real time, and achieve high levels of engagement in learning performance.

AR technologies implementation in education is just beginning to be explored, especially when using it with preschoolers. Cascales et al. [54] define AR as one of the most interesting emergent technologies for education, being a powerful and motivating tool which can involve several senses of the student by means of the proper combination of sound, sight and touch. In their paper the researchers attempted to track the likely linkage between parental influences and children's use of ICT, specifically AR, for educational purposes. The authors outline that the parents whose children have worked with AR are more satisfied with the results achieved

by their kids that those parents whose children have not worked with AR, although both groups have used the same educational system. According to the survey, the parents were very satisfied with the use of AR as a didactical resource. Firstly, parents like the AR technologies because they regard it as useful, facilitating the learning process and promoting motivation, knowledge, reading and writing, creativity and degree of satisfaction. Secondly, parents think that there are a lot of benefits in using a technological tool based on AR: the integration of several components in order to achieve a common goal, the possibility of managing the execution of the exercises in several contexts, or the availability of the system, among others. Thirdly, parents find that AR didactical resources allows to work children with different levels of difficulty which has shown to be useful in increasing comprehension. Fourthly, the families believe that the children who used the AR technology improve their reading and writing skills, so important in preschool education, therefore kids could obtain better final grades [54].

Tuli and Mantri [34] aimed to develop usability principles for mobile based AR applications for kindergarten kids. In their research work they reached their aim and categorized developed principles into 4 groups namely cognition, orientation, design and support. The authors give the definition of the created groups as follows:

1. Cognition: This group includes usability principles related to cognitive and intellectual aspects which improves thinking skills of the child like learnability, efficiency, reducing short term memory load, etc.
2. Orientation: This group includes the principles which define kid's understanding/interaction with the application such as enjoyment, customizability etc.
3. Design: This group includes the principles related to usage of the application by the children like interactive, simplicity etc.
4. Support: This group includes the principles related to the user support including error management, early test etc. [34].

In Nezhyva et al. [44] opinion, AR technologies application during the reading and writing lessons in primary school contributes to the effectiveness of learning in different directions, in particular: creates a Wow-effect and deepens emotional resonance from reading a work of art; becomes a powerful motivation for the reader's activity; compensates for the lack of development of the creative imagination of younger students; provides perception of artistic image by different sensory organs; activates students' interest in reading fiction; demonstrates to students the benefit of gadgets for learning and personal development.

Panchenko et al. [24] examine the problem of educators' training for using the AR books in educational process. Scholars referred to the results in previous author works on the potential of the massive open online courses (MOOCs) about AR, and mentioned their researches about content and program of the specialized course "Augmented Reality as a Storytelling Tool" for the professional development of teachers, and the difficulties of using storytelling in education and ways to overcome them. The authors highlight the need to use AR technologies in education because it can provide modern education with new didactic measurements and tools, will facilitate the co-creation of students and teachers, contribute to a better understanding of subjects, visualize hidden processes, and make it acceptable for adults and people with disabilities. The researchers define an AR textbook as a new educational tool which can contain fragments

of video lectures, electronic pads (for example, Padlet), augmented quizzes, 3D models, animated tours in the history of the studied problem, in-depth exercises, didactics games etc. The authors complement the specialized course “Digital Storytelling in Adult Education” for the system of professional training and retraining of educators with AR book creation module [24].

Tarasenko et al. [32] proclaim that the using AR technologies allow a person to quickly find and receive information about real objects, which can be represented in a symbolic, sound, graphic or animated form . They investigated the problem of the usage of AR elements for the formation of students’ communicative competence through a virtual tour. According to their survey the use of virtual excursions with AR elements increased the students’ interest and motivation to learn a foreign language. The authors trace the improving of the effectiveness of training and longer memorization of the studied content which is achieved through higher motivation for learning, the student’s independent actions and his/her emotional impression, active, and direct interaction with a real educational object based on AR technologies. The researchers state that the usage of AR technologies requires appropriate methodological didactic reorientation to create the opportunity for students to independently organize research, collect, evaluate, process and present information, apply complex hypertext structures, develop network thinking, work within flexible, group, project-oriented forms of training. In their article such advantages of AR technologies using in learning foreign languages, in particular German, were identified:

- AR technologies allow to achieve a higher level of assimilation of educational material, because various channels of perceiving information are involved (audial, visual, kinesthetic etc.);
- the student gets a more complete picture of the studied object due to the integrity of its representation, and then faster memorize new words, especially terminology, which remain in memory longer since are used in context;
- AR technologies application helps the students get know the spatially remoted objects, and understand the essence or purpose of these objects and remember the vocabulary associated with them;
- faster memorization of new vocabulary is supported by the parallel presentation of information case together with selected objects for study, which allows students to quickly receive extended information using AR technologies;
- the usage of AR technologies to conduct a virtual tour allow students to develop communicative foreign language skills, exactly during the work in a group;
- AR technologies are a good tool for learning a foreign language, because they allow the student to learn at his/her own pace [32].

Cadavieco et al. [55] concluded that a working environment where AR technologies can be used is an alternative to the traditional iconic resources (blackboard, computer, projectors, etc.), as they are enhanced by additional information. The authors categorize 4 types of AR applications:

Type 1 – Geolocation: image including details of its geographic location (GPS) and other relevant data such as information on public establishments, guidelines and suggestions of traffic routes.

Type 2 – Pattern/Tag/Marker/QR-Code/Semacode: image with data regarding a specific original pattern.

Type 3 – Image and software: this option allows differentiation between the key features captured by an application that turns them into measurements.

Type 4 – Recognition and browser: an image can be compared to related pictures on the Internet in order to add relevant information [55].

Thus, according to the analysis of scientific papers, the use of AR technologies has significant potential for the effective organization of the educational process of future teachers-philologists. AR technologies allow to visually reproduce the created learning environment and interact with it, to form modern digital competencies of future teachers of Ukrainian language and literature, to give emotional and cognitive-practical experience, which helps to involve students in the systematic acquisition of professional knowledge and competencies.

2.2. Features of creating AR in the professional training of students-philologists

The specificity of AR technologies application in the discipline “Methodic of teaching literature” is the ability to create such a reality with reference either to the marker image (AR will be read only from a specific image anywhere and at any time), or to geolocation (AR will be read only in the place where it was created). For our educational needs we used that type which is based on marker image.

Pochtoviuk et al. [25] describe how AR based on the marker image works:

1. The camera finds a real-world marker and then transmits information about it to a tablet or smartphone.
2. Special AR application replace marker by virtual object (text, music, video, 3D model, etc.) and displays it on the screen.
3. The camera then tracks the movements of the marker, and the application allows you to control the objects.

The creation of AR during the study of the discipline “Methodic of teaching literature” was aimed at organizing the professional training of students-philologists with the help of trendy educational technology, so that they become familiar with the newest technologies and teaching methods, get ready to implement educational innovations in the educational process. But it is clear that the future teachers of Ukrainian language and literature should take into account the expediency of using a particular technology, which is needed not only for spectacular training, but also to achieve its effectiveness.

We describe the sequence of actions to create AR and its subsequent content filling. The example of our experience of the usage AR application in educational process with students-philologists is based on the existing free of charge trial version of software (such as the mobile application Unite for Android).

1. AR creation through the mobile application Unite on Android. To do this, download the application to your mobile phone, click on the button at the top left, select “Create AR”, register, i.e. create your own profile. In addition, you can also use the website <https://app.unitear.com> to create a new project with AR.

- The next step is to create your own project. To do this, select the “Image-Based AR” section on the left and click on the “Add new Project” button which is demonstrated in figure 1.

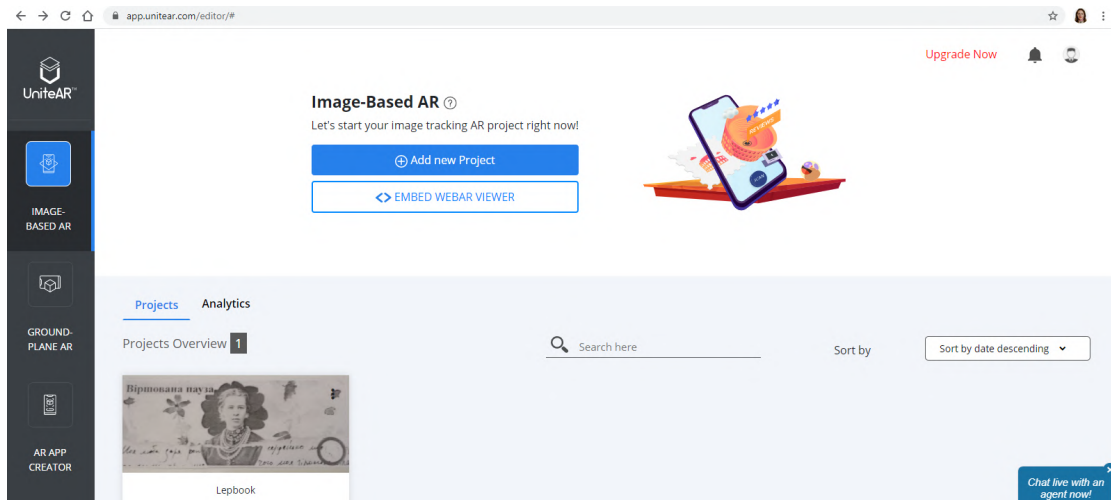

Figure 1: The interface of AR application Unite on PC.

- Then upload your target image. You can choose your detection mode between Image Detection and Image Detection with QR. We selected Image Detection and uploaded image in jpeg format (generally, supported format: jpeg, jpg, png) and up to 10 MB in size. The proposed choice between detection modes are shown in figure 2.

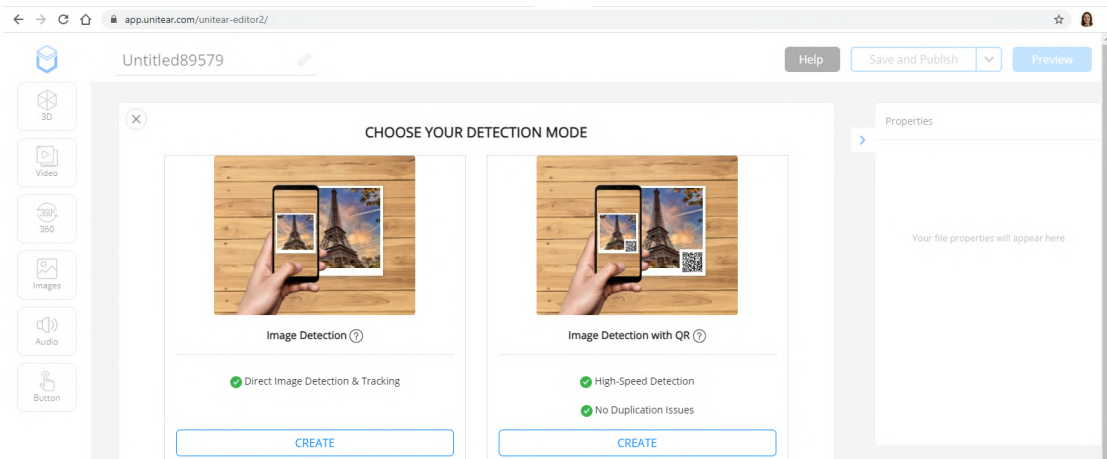

Figure 2: The choice between detection mode.

- Next, you can choose which AR effect will be applied to the image marker. Mobile AR

application Unite offers the following options:

- Upload your 3D Model (Supported format: obj, fbx, glb, zip containing fbx with texture image folder);
- Upload your Video in mp4 format or Paste your YouTube Video Link;
- Upload your Panoramic Video in mp4 format or Image for 360-degree experience;
- Upload your Slideshow Images or Animated Gif (Supported format: png, jpg, jpeg, gif);
- Upload your Audio files in wav, mp3 format and hear it when a user scans the target image;
- Create your own Button. Here you can select the type of your button (Call, Link, Email) and enter the required data and your Label, select Button color and Text color or download the finished image for the button (figure 3).

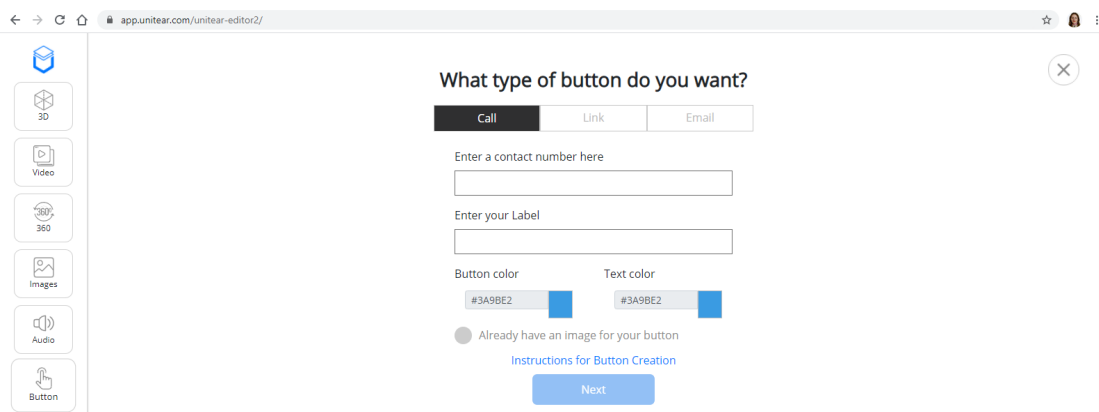

Figure 3: The choice of the type of button.

5. After downloading certain content, you can align its position relative to the base image-marker.
6. New marker images can be added to the same newly created project and specific educational content can be superimposed on them (figure 4). Once the project is completed, you can view and save it. The advantage of this program is the ability to return to the project and, if necessary, edit it.

The implementation AR technologies in learning process requires to be arranged pedagogical in a significant way (considering the student's age and his/her former knowledge and skills, and by the logical structure of the topic to be taught). Students-philologists join the creation of AR during studying the discipline "Methodic of teaching literature". Thus, the future teachers of Ukrainian language and literature become proficient in the newest technologies on their own, master the skills needed for a teacher of the 21st century, learn to work both individually and in a group, present their work on a public, improve knowledge both in professional subjects and in English (AR application interface is in English only).

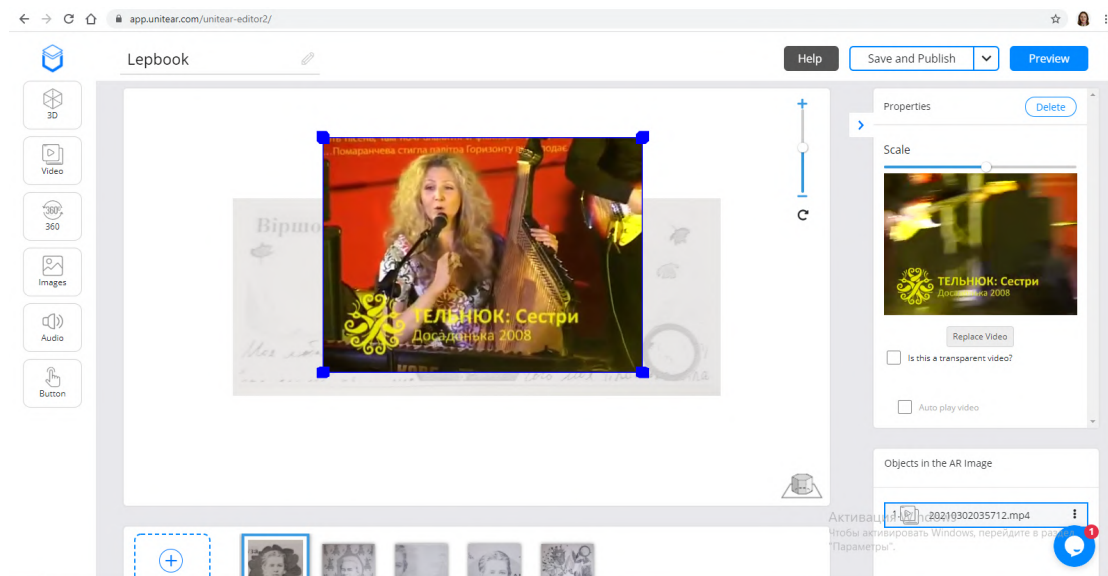

Figure 4: The overlay the educational video content on image marker.

2.3. Features of the methodic of using AR based on a lepbook

Choosing organizational methods, techniques and forms of teaching [56], we give preference to creative elements over reproductive ones in educational activities of future teachers of Ukrainian language and literature. That motivate students to further develop their professional and creative qualities and form their experience of pedagogical creativity. Because, as Kucevol [57] points out, the peculiarity of creative professional activity is that its experience cannot be transferred by informing or illustrating, but its only acquired during the personal students' involvement in creative work.

We will reveal the features of the implementation of ICT, in particular AR technologies, during practicum on “Methodic of teaching literature”. We offer to your attention a fragment of a practical class “Methods and techniques of teaching literature”, which was aimed at forming students' understanding of the classification of methods and techniques of teaching literature by modern methodologists, analysis of methods of introducing innovative and information and communication technologies in the work of teachers-philologists.

To get acquainted with AR technologies, at first students-philologists were asked to create the lepbook “Incredible Lesya Ukrainka”. Most of the information pockets of the lepbook were made with elements of augmented reality. Among them are the following rubrics: “Biography of the writer”, “Surrounding of Lesya Ukrainka”, “Poetic pause”, “Lesya Ukrainka in the 21st century”, “And you know...”.

To visualize the educational material for the rubric “Biography of the writer”, students-philologists created an animation of Lesya Ukrainka's photo using the Deep Nostalgia function on MyHeritage. With this technology, you can animate faces in historical photos and create high-quality, realistic videos that reproduce the movements of a person on a photo in such a

way you can see how this person smile, blink, and turn her head. This AR animation is shown in a figure 5.



Figure 5: The demonstration of AR animation in the rubric “Biography of the writer”.

Next development of the AR will help to deepen the students’ knowledge about Lesya Ukrainka’s surrounding by clicking on the “11 Lesya’s friends” button and then following the hyperlink (figure 6).



Figure 6: The demonstration of AR link button in the rubric “Surrounding of Lesya Ukrainka”.

The AR content in the rubric “Poetic pause” was a video of the performance of the musical band “Sisters Telnyuk” with the song “Dosadon’ka” on the words of the poem by Lesya Ukrainka “Oh, it seems – I’m not in a sorrow...”. That is demonstrated in figure 7.

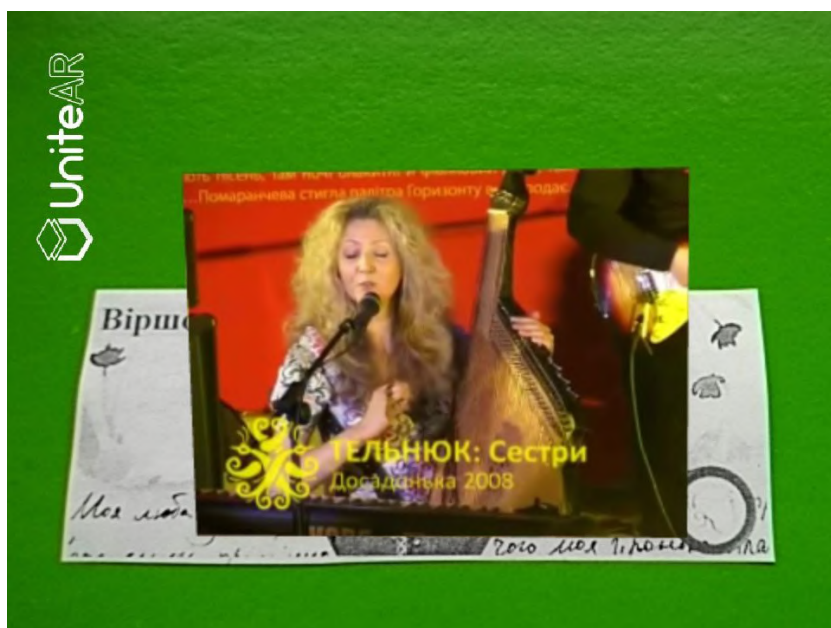

Figure 7: The video demonstration of AR in the rubric “Poetic pause”.

With the help of AR technologies, students-philologists were able to visualize the most popular modern illustrations of the writer’s image by illustrators and artists in the 21st century. They are shown in a figure 8.

Next rubric “And you know...” thanks to AR technologies presents a sound recording of Lesya Ukrainka’s singing (figure 9).

We specifically used black and white marker images. This was done to achieve a greater effect from the visualization of AR. After all, superimposed educational content is bright and colored videos, animations, images, etc. So, at first students perceive the seen lepbook as a usual traditional way of bringing educational material to learners, but everything changes after instructions to download the AR application Unite and to create their new project, then to aim the camera at the marker image and to read the AR. The black and white marker image seems to come to life. This causes an unforgettable, strong emotional impact on students-philologists, fascinates them, arouses the desire to create AR again during the studying the discipline, and in further professional activities.

3. Conclusions and prospects for further research

We are convinced that the effectiveness of professional training of the future teachers of Ukrainian language and literature to professional activity directly proportionally depends on



Figure 8: AR content in the rubric “Lesya Ukrainka in the 21st century”.

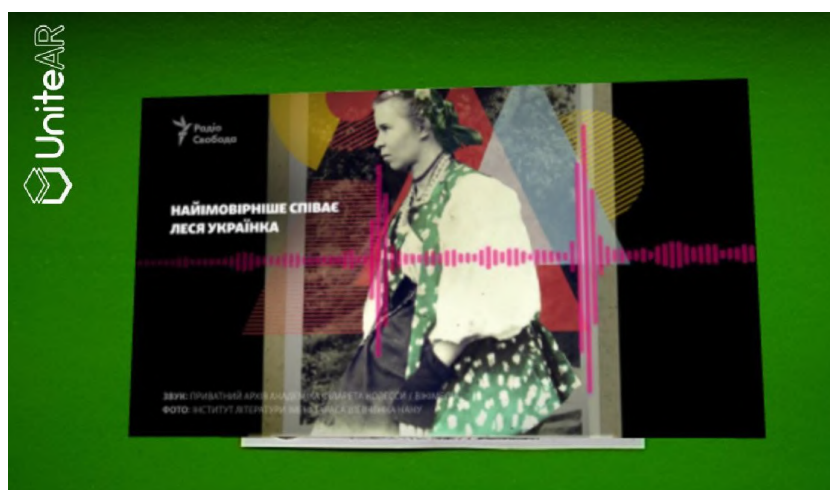

Figure 9: AR audio content in the rubric “And you know...”.

the usage of ICT in the learning process, especially AR technologies, which modernizes the studying and activates students to research and creative work, arouses their desire for self-development, self-education and professional self-realization etc. In addition, the usage of AR technologies provides an emotional and cognitive experience that helps to involve students in systematic learning.

With the help of AR technologies, the usage of a lepbook permits students to improve the assimilation of theoretical material, allows to deepen it and contributes to its better illustration,

which in turn increases students' cognitive activity and develops their creative thinking. Using a mobile phone or tablet allows students to reproduce AR on the marker images which are placed on a lepbook anywhere and anytime. AR technologies don't require being in front of a computer or laptop. The only condition is the availability of the Internet.

Mobile AR application Unite provides the ability to visualize educational content of the lepbook "Incredible Lesya Ukrainka", made by students-philologists at the Mykhailo Stelmakh Faculty of Philology and Journalism of Vinnytsia Mykhailo Kotsiubynskyi State Pedagogical University during the studying the discipline "Methodic of teaching literature".

Thus, AR technologies help in the practice-oriented professional development of the future teachers-philologists and their self-improvement during preparation for educational activities.

A prospects area for further research is the study of the possibilities of using AR technologies in lessons of Ukrainian literature at secondary school.

References

- [1] R. O. Tarasenko, S. M. Amelina, S. O. Semerikov, V. D. Shynkaruk, Using interactive semantic networks as an augmented reality element in autonomous learning, *Journal of Physics: Conference Series* 1946 (2021) 012023. doi:10.1088/1742-6596/1946/1/012023.
- [2] E. Komarova, T. Starova, Majority values of school biological education in the context of education for sustainable development, *E3S Web of Conferences* 166 (2020) 10029. doi:10.1051/e3sconf/202016610029.
- [3] A. E. Kiv, V. V. Bilous, D. M. Bodnenko, D. V. Horbatovskyi, O. S. Lytvyn, V. V. Proshkin, The development and use of mobile app ar physics in physics teaching at the university, *CEUR Workshop Proceedings* (2021).
- [4] P. Nechypurenko, T. Starova, T. Selivanova, A. Tomilina, A. Uchitel, Use of augmented reality in chemistry education, *CEUR Workshop Proceedings* 2257 (2018) 15–23.
- [5] L. Y. Midak, I. V. Kravets, O. V. Kuzyshyn, T. V. Kostyuk, K. V. Buzhdyhan, V. M. Lutsyshyn, I. O. Hladkoskok, A. E. Kiv, M. P. Shyshkina, Augmented reality while studying radiochemistry for the upcoming chemistry teachers, *CEUR Workshop Proceedings* (2021).
- [6] T. Kramarenko, O. Pylypenko, I. Muzyka, Application of GeoGebra in Stereometry teaching, *CEUR Workshop Proceedings* 2643 (2020) 705–718.
- [7] Z. S. Seidametova, Z. S. Abduramanov, G. S. Seydametov, Using augmented reality for architecture artifacts visualizations, *CEUR Workshop Proceedings* (2021).
- [8] I. Mintii, V. Soloviev, Augmented reality: Ukrainian present business and future education, *CEUR Workshop Proceedings* 2257 (2018) 227–231.
- [9] P. Milgram, H. Takemura, A. Utsumi, F. Kishino, Augmented reality: a class of displays on the reality-virtuality continuum, *Telemanipulator and Telepresence Technologies* 2351 (1995) 282–292. doi:10.1117/12.197321.
- [10] P. Milgram, F. Kishino, A taxonomy of mixed reality visual displays, *IEICE Trans. Information Systems* E77-D (1994) 1321–1329.
- [11] R. T. Azuma, A survey of augmented reality, *Presence: Teleoperators and Virtual Environments* 6 (1997) 355–385. URL: <https://www.cs.unc.edu/~azuma/ARpresence.pdf>. doi:10.1162/pres.1997.6.4.355.

- [12] V. V. Babkin, V. V. Sharavara, V. V. Sharavara, V. V. Bilous, A. V. Voznyak, S. Y. Kharchenko, Using augmented reality in university education for future IT specialists: educational process and student research work, CEUR Workshop Proceedings (2021).
- [13] O. Burov, A. Kiv, S. Semerikov, A. Striuk, M. Striuk, L. Kolgatina, I. Oliinyk, AREdu 2020 - How augmented reality helps during the coronavirus pandemic, CEUR Workshop Proceedings 2731 (2020) 1–46.
- [14] S. Gargrish, A. Mantri, D. P. Kaur, Augmented reality-based learning environment to enhance teaching-learning experience in geometry education, Procedia Computer Science 172 (2020) 1039–1046. doi:10.1016/j.procs.2020.05.152, 9th World Engineering Education Forum (WEEF 2019) Proceedings : Disruptive Engineering Education for Sustainable Development.
- [15] T. Jerabek, V. Rambousek, R. Wildova, Specifics of visual perception of the augmented reality in the context of education, Procedia - Social and Behavioral Sciences 159 (2014) 598–604. doi:10.1016/j.sbspro.2014.12.432, 5th World Conference on Psychology, Counseling and Guidance, WCPCG-2014, 1-3 May 2014, Dubrovnik, Croatia.
- [16] D. P. Kaur, A. Mantri, B. Horan, Enhancing student motivation with use of augmented reality for interactive learning in engineering education, Procedia Computer Science 172 (2020) 881–885. doi:10.1016/j.procs.2020.05.127, 9th World Engineering Education Forum (WEEF 2019) Proceedings : Disruptive Engineering Education for Sustainable Development.
- [17] A. Kiv, M. Shyshkina, S. Semerikov, A. Striuk, Y. Yechkalo, AREdu 2019 – How augmented reality transforms to augmented learning, CEUR Workshop Proceedings 2547 (2020) 1–12.
- [18] T. Kolomoiets, D. Kassim, Using the augmented reality to teach of global reading of preschoolers with autism spectrum disorders, CEUR Workshop Proceedings 2257 (2018) 237–246.
- [19] T. Kramarenko, O. Pylypenko, V. Zaselskiy, Prospects of using the augmented reality application in STEM-based Mathematics teaching, CEUR Workshop Proceedings 2547 (2020) 130–144.
- [20] O. Lavrentieva, I. Arkhypov, O. Kuchma, A. Uchitel, Use of simulators together with virtual and augmented reality in the system of welders' vocational training: Past, present, and future, CEUR Workshop Proceedings 2547 (2020) 201–216.
- [21] O. Lavrentieva, I. Arkhypov, O. Krupskiy, D. Velykodnyi, S. Filatov, Methodology of using mobile apps with augmented reality in students' vocational preparation process for transport industry, CEUR Workshop Proceedings 2731 (2020) 143–162.
- [22] P. Nechypurenko, V. Stoliarenko, T. Starova, T. Selivanova, O. Markova, Y. Modlo, E. Shmeltser, Development and implementation of educational resources in chemistry with elements of augmented reality, CEUR Workshop Proceedings 2547 (2020) 156–167.
- [23] S. P. Palamar, G. V. Bieliienka, T. O. Ponomarenko, L. V. Kozak, L. L. Nezhyva, A. V. Voznyak, Formation of readiness of future teachers to use augmented reality in the educational process of preschool and primary education, CEUR Workshop Proceedings (2021).
- [24] L. Panchenko, T. Vakaliuk, K. Vlasenko, Augmented reality books: Concepts, typology, tools, CEUR Workshop Proceedings 2731 (2020) 283–296. URL: <http://ceur-ws.org/Vol-2731/paper16.pdf>.
- [25] S. Pochtoviuk, T. Vakaliuk, A. Pikilnyak, Possibilities of application of augmented reality

- in different branches of education, *CEUR Workshop Proceedings* 2547 (2020) 92–106. URL: <http://ceur-ws.org/Vol-2547/paper07.pdf>.
- [26] N. Rashevskaya, V. Soloviev, Augmented reality and the prospects for applying its in the training of future engineers, *CEUR Workshop Proceedings* 2257 (2018) 192–197.
- [27] N. Rashevskaya, S. Semerikov, N. Zinonos, V. Tkachuk, M. Shyshkina, Using augmented reality tools in the teaching of two-dimensional plane geometry, *CEUR Workshop Proceedings* 2731 (2020) 79–90.
- [28] D. Scaravetti, D. Doroszewski, Augmented reality experiment in higher education, for complex system appropriation in mechanical design, *Procedia CIRP* 84 (2019) 197–202. doi:10.1016/j.procir.2019.04.284, 29th CIRP Design Conference 2019, 08-10 May 2019, Póvoa de Varzim, Portugal.
- [29] D. S. Shepiliev, S. O. Semerikov, Y. V. Yechkalo, V. V. Tkachuk, O. M. Markova, Y. O. Modlo, I. S. Mintii, M. M. Mintii, T. V. Selivanova, N. K. Maksyshko, T. A. Vakaliuk, V. V. Osadchyi, R. O. Tarasenko, S. M. Amelina, A. E. Kiv, Development of career guidance quests using WebAR, *Journal of Physics: Conference Series* 1840 (2021) 012028. doi:10.1088/1742-6596/1840/1/012028.
- [30] S. O. Semerikov, M. M. Mintii, I. S. Mintii, Review of the course “Development of Virtual and Augmented Reality Software” for STEM teachers: implementation results and improvement potentials, *CEUR Workshop Proceedings* (2021).
- [31] A. Striuk, M. Rassoavytska, S. Shokaliuk, Using Blippar augmented reality browser in the practical training of mechanical engineers, *CEUR Workshop Proceedings* 2104 (2018) 412–419.
- [32] R. Tarasenko, S. Amelina, Y. Kazhan, O. Bondarenko, The use of AR elements in the study of foreign languages at the university, *CEUR Workshop Proceedings* 2731 (2020) 129–142. URL: <http://ceur-ws.org/Vol-2731/paper06.pdf>.
- [33] V. Tkachuk, Y. Yechkalo, S. Semerikov, M. Kislova, Y. Hladyr, Using Mobile ICT for Online Learning During COVID-19 Lockdown, in: A. Bollin, V. Ermolayev, H. C. Mayr, M. Nikitchenko, A. Spivakovsky, M. Tkachuk, V. Yakovyna, G. Zholtkevych (Eds.), *Information and Communication Technologies in Education, Research, and Industrial Applications*, Springer International Publishing, Cham, 2021, pp. 46–67.
- [34] N. Tuli, A. Mantri, Usability principles for augmented reality based kindergarten applications, *Procedia Computer Science* 172 (2020) 679–687. doi:10.1016/j.procs.2020.05.089, 9th World Engineering Education Forum (WEEF 2019) Proceedings : Disruptive Engineering Education for Sustainable Development.
- [35] T. A. Vakaliuk, S. I. Pochtoviuk, Analysis of tools for the development of augmented reality technologies, *CEUR Workshop Proceedings* (2021).
- [36] S. Zelinska, A. Azaryan, V. Azaryan, Investigation of opportunities of the practical application of the augmented reality technologies in the information and educative environment for mining engineers training in the higher education establishment, *CEUR Workshop Proceedings* 2257 (2018) 204–214.
- [37] X. Zhou, L. Tang, D. Lin, W. Han, Virtual and augmented reality for biological microscope in experiment education, *Virtual Reality and Intelligent Hardware* 2 (2020) 316–329. doi:10.1016/j.vrih.2020.07.004.
- [38] N. Zinonos, E. Vihrova, A. Pikilnyak, Prospects of using the augmented reality for train-

- ing foreign students at the preparatory departments of universities in Ukraine, CEUR Workshop Proceedings 2257 (2018) 87–92.
- [39] A. Iatsyshyn, V. Kovach, Y. Romanenko, I. Deinega, A. Iatsyshyn, O. Popov, Y. Kutsan, V. Artemchuk, O. Burov, S. Lytvynova, Application of augmented reality technologies for preparation of specialists of new technological era, CEUR Workshop Proceedings 2547 (2020) 181–200. URL: <http://ceur-ws.org/Vol-2547/paper14.pdf>.
- [40] F. Liarokapis, Augmented reality interfaces for assisting computer games university students, Bulletin of the IEEE Technical Committee on Learning Technology 14 (2012) 7–10.
- [41] I. Radu, Why should my students use ar: A comparative review of the educational impacts of augmented reality, in: 2012 IEEE International Symposium on Mixed and Augmented Reality (ISMAR), 2012, pp. 313–314. doi:10.1109/ismar.2012.6402590.
- [42] I. de A. Souza-Concilio, B. A. Pacheco, The development of augmented reality systems in informatics higher education, Procedia Computer Science 25 (2013) 179–188. doi:10.1016/j.procs.2013.11.022, 2013 International Conference on Virtual and Augmented Reality in Education.
- [43] H. Ramirez, E. G. Mendivil, P. R. Flores, M. C. Gonzalez, Authoring software for augmented reality applications for the use of maintenance and training process, Procedia Computer Science 25 (2013) 189–193. doi:10.1016/j.procs.2013.11.023, 2013 International Conference on Virtual and Augmented Reality in Education.
- [44] L. Nezhyva, S. Palamar, O. Lytvyn, Perspectives on the use of augmented reality within the linguistic and literary field of primary education, CEUR Workshop Proceedings 2731 (2020) 297–311. URL: <http://ceur-ws.org/Vol-2731/paper17.pdf>.
- [45] M. Kesim, Y. Ozarslan, Augmented reality in education: Current technologies and the potential for education, Procedia - Social and Behavioral Sciences 47 (2012) 297–302. doi:10.1016/j.sbspro.2012.06.654, cyprus International Conference on Educational Research (CY-ICER-2012) North Cyprus, US08-10 February, 2012.
- [46] M. T. Coimbra, T. Cardoso, A. Mateus, Augmented reality: An enhancer for higher education students in math's learning?, Procedia Computer Science 67 (2015) 332–339. doi:10.1016/j.procs.2015.09.277, proceedings of the 6th International Conference on Software Development and Technologies for Enhancing Accessibility and Fighting Info-exclusion.
- [47] J. Bacca, S. Baldiris, R. Fabregat, Kinshuk, S. Graf, Mobile augmented reality in vocational education and training, Procedia Computer Science 75 (2015) 49–58. doi:10.1016/j.procs.2015.12.203, 2015 International Conference Virtual and Augmented Reality in Education.
- [48] K. J. Mendez, R. J. Piasecki, K. Hudson, S. Renda, N. Mollenkopf, B. S. Nettles, H.-R. Han, Virtual and augmented reality: Implications for the future of nursing education, Nurse Education Today 93 (2020) 104531. doi:10.1016/j.nedt.2020.104531.
- [49] H. Salmi, A. Kaasinen, V. Kallunki, Towards an open learning environment via augmented reality (ar): Visualising the invisible in science centres and schools for teacher education, Procedia - Social and Behavioral Sciences 45 (2012) 284–295. doi:10.1016/j.sbspro.2012.06.565, the 5th International Conference of Intercultural Arts Education 2012: Design Learning, University of Helsinki, Finland.
- [50] C. Uriel, S. Sergio, G. Carolina, G. Mariano, D. Paola, A. Martín, Improving the understand-

- ing of basic sciences concepts by using virtual and augmented reality, *Procedia Computer Science* 172 (2020) 389–392. doi:10.1016/j.procs.2020.05.165, 9th World Engineering Education Forum (WEEF 2019) Proceedings : Disruptive Engineering Education for Sustainable Development.
- [51] V. Osadchyi, H. Chemerys, K. Osadcha, V. Krulyk, S. Koniukhov, A. Kiv, Conceptual model of learning based on the combined capabilities of augmented and virtual reality technologies with adaptive learning systems, *CEUR Workshop Proceedings* 2731 (2020) 328–340.
- [52] V. V. Osadchyi, N. V. Valko, L. V. Kuzmich, Using augmented reality technologies for STEM education organization, *Journal of Physics: Conference Series* 1840 (2021) 012027. doi:10.1088/1742-6596/1840/1/012027.
- [53] D. Nincarean, M. B. Alia, N. D. A. Halim, M. H. A. Rahman, Mobile augmented reality: The potential for education, *Procedia - Social and Behavioral Sciences* 103 (2013) 657–664. doi:10.1016/j.sbspro.2013.10.385, 13th International Educational Technology Conference.
- [54] A. Cascales, D. Pérez-López, M. Contero, Study on parent's acceptance of the augmented reality use for preschool education, *Procedia Computer Science* 25 (2013) 420–427. doi:10.1016/j.procs.2013.11.053, 2013 International Conference on Virtual and Augmented Reality in Education.
- [55] J. F. Cadavieco, M. de Fatima Goulão, A. F. Costales, Using augmented reality and m-learning to optimize students performance in higher education, *Procedia - Social and Behavioral Sciences* 46 (2012) 2970–2977. doi:10.1016/j.sbspro.2012.05.599, 4th WORLD CONFERENCE ON EDUCATIONAL SCIENCES (WCES-2012) 02-05 February 2012 Barcelona, Spain.
- [56] S. O. Semerikov, I. O. Teplytskyi, V. N. Soloviev, V. A. Hamaniuk, N. S. Ponomareva, O. H. Kolgatin, L. S. Kolgatina, T. V. Byelyavtseva, S. M. Amelina, R. O. Tarasenko, Methodic quest: Reinventing the system, *Journal of Physics: Conference Series* 1840 (2021) 012036. doi:10.1088/1742-6596/1840/1/012036.
- [57] O. Kucevol, *Teoretyko-metodychni osnovy rozvytku kreatyvnosti majbutnix uchyteliv literatury (Theoretical and methodological bases of development of creativity of future teachers of literature)*, Globe Press, Vinnytsia, 2006.

Formation of readiness of future teachers to use augmented reality in the educational process of preschool and primary education

Svitlana P. Palamar¹, Ganna V. Bieliienka¹, Tatyana O. Ponomarenko¹,
Liudmyla V. Kozak¹, Liudmyla L. Nezhyva¹ and Andrei V. Voznyak²

¹*Borys Grinchenko Kyiv University, 18/2, Bulvarno-Kudriavska Str., Kyiv, 04053, Ukraine*

²*Kryvyi Rih State Pedagogical University, 54 Gagarin Ave., Kryvyi Rih, 50086, Ukraine*

Abstract

The article substantiates the importance of training future teachers to use AR technologies in the educational process of preschool and primary education. Scientific sources on the problem of AR application in education are analyzed. Possibilities of using AR in work with preschoolers and junior schoolchildren are considered. Aspects of research of the problem of introduction of AR in education carried out by modern foreign and domestic scientists are defined, namely: use of AR-applications in education; introduction of 3D technologies, virtual and augmented reality in the educational process of preschool and primary school; 3D, virtual and augmented reality technologies in higher education; increase of the efficiency of learning and motivating students through the use of AR-applications on smartphones; formation of reading culture by means of augmented reality technology; prospects for the use of augmented reality within the linguistic and literary field of preschool and primary education. The authors analyzed the specifics of toys with AR-applications, interactive alphabets, coloring books, encyclopedias and art books of Ukrainian and foreign writers, which should be used in working with children of preschool and primary school age; the possibilities of books for preschool children created with the help of augmented reality technologies are demonstrated. The relevance of the use of AR for the effective education and development of preschoolers and primary school children is determined. Problems in the application of AR in the educational process of modern domestic preschool education institutions are outlined. A method of diagnostic research of the level and features of readiness of future teachers to use AR in the educational process of preschool and primary education has been developed. Criteria, indicators are defined, the levels of development of the main components of the studied readiness (motivational, cognitive, activity) are characterized. The insufficiency of its formation in future teachers in the field of preschool and primary education; inconsistency between the peculiarities of training future teachers to use AR in professional activities and modern requirements for the quality of the educational process; the need to develop and implement a holistic system of formation of the studied readiness of future teachers in the conditions of higher pedagogical education are proved. A model of forming the readiness of future teachers to use AR in the educational process of preschool and primary education has been developed.

Keywords

augmented reality (AR), digital technologies, teaching aids, educational process, preschool education, primary education, higher education institution (HEI), future teachers

1. Introduction

1.1. Problem statement

In modern society, the development of digital technologies makes it possible to modernize the educational process, using various trends in modern education. The use of digital technologies in teaching can accelerate the transfer of experience, as well as improve the quality of education by maximizing the involvement of the child in the educational process. The real trend of today is augmented reality (AR) – complementing the physical world with real-time digital data. It is actually a technology for applying virtual reality to objects in the physical world. The use of this technology in the educational process of preschool and primary education increases the level of assimilation of information due to the interactivity of its presentation in 3D, allows teachers to quickly and easily explain difficult to imagine educational material, and children easily learn it. Moreover, it promotes creativity, increases the cognitive activity of children, helps to keep their attention longer, because augmented reality causes children to admire and feel something extraordinary. This is especially important for higher pedagogical education, as the future teacher must master these technologies in order to successfully apply them in their further professional activities. The development of the teacher depends on a deep understanding of the child's current needs, prospects and priorities of education, the ability to master new technologies and teach children to achieve a common goal through modern ICT.

1.2. Literature review

We have analyzed a number of studies that focus on the use of AR technologies in a wide range of educational contexts [1, 2, 3, 4, 5, 6] and provide an appropriate understanding of how AR technology helps the education of students [7, 8, 9, 10, 11, 12, 13, 14, 15], pupils [16, 17] and preschool children [18] in educational institutions.

The educational experience of augmented reality, as noted by Billingham [19], has a number of reasons: support for the interaction between real and virtual environments; using a tangible interface metaphor to manipulate objects; the possibility of a smooth transition between reality and virtuality.

Kesim and Ozarslan [20] note that combining AR technology with learning content increases the efficiency and attractiveness of teaching and learning, as it improves students' perception

AREdu 2021: 4th International Workshop on Augmented Reality in Education, May 11, 2021, Kryvyi Rih, Ukraine

✉ s.palamar@kubg.edu.ua (S. P. Palamar); h.bielienska@kubg.edu.ua (G. V. Bielienska); t.ponomarenko@kubg.edu.ua (T. O. Ponomarenko); l.kozak@kubg.edu.ua (L. V. Kozak); l.nezhyva@kubg.edu.ua (L. L. Nezhyva); avvoznyak76@gmail.com (A. V. Voznyak)

🌐 <http://eportfolio.kubg.edu.ua/teacher/1109> (S. P. Palamar); <http://eportfolio.kubg.edu.ua/teacher/334> (G. V. Bielienska); <http://eportfolio.kubg.edu.ua/teacher/689> (T. O. Ponomarenko); <http://eportfolio.kubg.edu.ua/teacher/251> (L. V. Kozak); <http://eportfolio.kubg.edu.ua/teacher/2445> (L. L. Nezhyva); <https://kdpu.edu.ua/personal/avvoznyak.html> (A. V. Voznyak)

🆔 0000-0001-6123-241X (S. P. Palamar); 0000-0003-2759-1149 (G. V. Bielienska); 0000-0002-6801-0403 (T. O. Ponomarenko); 0000-0002-4528-1905 (L. V. Kozak); 0000-0001-9520-0694 (L. L. Nezhyva); 0000-0003-4683-1136 (A. V. Voznyak)

 © 2021 Copyright for this paper by its authors.
Use permitted under Creative Commons License Attribution 4.0 International (CC BY 4.0).

 CEUR Workshop Proceedings (CEUR-WS.org)

of and interaction with the real world. With the help of augmented reality systems, students interact with 3D information, objects and events in a natural way. They can move around a three-dimensional virtual image and view it from any point of view, like a real object. The information conveyed by virtual objects helps students complete real tasks.

Dutta [21] believes that the practical and visual aspects of learning also help to speed up the understanding of the content of the material, as visual memory is strongly stimulated. The author's research has shown that the use of AR technology significantly increases the amount of information that students remember, and that, in addition, this information is stored in long-term memory.

Exploring the use of augmented reality technology in a mobile-oriented learning environment of higher education, Syrovatskyi et al. [22], Tkachuk et al. [23] conclude that the use of AR tools provides an opportunity to increase the realism of the study; provides emotional and cognitive experience that helps to involve students in systematic learning; creates new ways of presenting real objects in the learning process; motivates students to experimental and research work.

Determining the didactic potential of virtual information learning, Bondarenko et al. [24] emphasize such features of VR and AR as immersion, dynamism, sense of presence, continuity, causality, intensification of the learning process, saving time on material processing. Supporting the effectiveness of VR and AR training, the authors also point out the shortcomings, including low levels of computerization, little quantity and low quality of software products.

According to Salvador-Herranz et al. [25], this training is experimental. Thus, the more senses involved (sound, sight, touch, emotions, etc.), the stronger is the learning experience. In this context, augmented reality can play an important role in supporting experimental learning and providing students with an attractive technological tool to support their learning activities. Researchers have developed the AR application, which combines 3D models and animation, mini-games and quizzes. The developers chose a subject for primary school "Knowledge of the natural, social and cultural environment". The AR system, called Realitat3, consists of the AR mechanism and six AR applications: the skeletal system, the water cycle, plant development, the metamorphosis of frogs, the solar system, and the sense organs. Parhizkar et al. [26] developed a mobile application for primary school to provide children with a new level of experience in general scientific concepts such as materials, solids, liquids and gases, the various phenomena they pass through, the universe and galaxies, major parts human skeleton, digestive and respiratory systems, etc. Midak et al. [27] created a mobile AR-application for visualization of educational material in natural sciences.

Prospects for the use of virtual and augmented reality in the educational process of the Ukrainian school are studied by Osipova et al. [28]. The problem of forming a culture of reading by means of augmented reality technology is studied by Bessarab [29]. The study of Nezhyva et al. [30] is dedicated to the use of augmented reality in the language and literature of primary education, in particular, researchers note that the visualization of the artistic image by augmented reality contributes to the effectiveness of learning in various areas, namely: created a WOW-effect, surprises, with what deepens the emotional resonance of reading a work of art; becomes a powerful motivation for reading; promote the development of creative imagination; provides the perception of the artistic image by various senses; demonstrates to children the benefits of gadgets for learning and personal development.

In preschool education there is also an opportunity to apply augmented reality technologies.

Such products include toys with AR applications, travel games, coloring books, interactive alphabets, encyclopedias and art books by Ukrainian and foreign writers.

Thus, most publications on this issue indicate the possibility of using AR technologies in education to visually model educational material, complement it with clarity, provide children with emotional and cognitive experience, research and experimentation skills, which accelerates learning and makes this process interesting and active

1.3. The aim of the research

Analysis of scientific sources and practical experience of teachers shows that AR can be used in various activities of preschoolers and primary school children: play, language and literature, sensory-cognitive, research, artistic, etc., in particular to get acquainted with animals, human professions, literary characters, space, numbers, letters, etc.

However, the problem is that the use of AR technology is not provided by the programs of education and development of preschoolers and primary school children, but textbooks (except for the textbook and universal didactic material on AR to the integrated course “I explore the world” for primary school students) do not contain suggestions and tasks that may involve the use of augmented reality in the educational process, teachers study the new technology mostly them-selves and apply it spontaneously. In addition, there are psychological barriers to the use of new technologies by educators. Many of them continue to work as usual. Therefore, it is important to form in future teachers the ability to use AR in the educational process of preschool and primary education.

The purpose of this article is to substantiate the need to form the readiness of future teachers to use AR in the educational process of preschool and primary education, to develop a model of formation of this readiness in students of pedagogical institutes.

To achieve this goal it is necessary to solve the following tasks: to analyze scientific sources on the application of AR in education; consider the possibility of using AR in working with preschoolers and younger students; to analyze the specifics of publications of works of art, encyclopedias, coloring books, toys with AR-applications, which are appropriate to use in working with preschoolers and younger students; to investigate the current state of readiness of future teachers to use AR in professional educational activities; to develop criteria and levels of readiness of future teachers for the use of AR in the educational process of preschool and primary education, the stages of formation of this readiness.

2. Discussion

The results of the analysis of the essence of AR technology and the content of competencies (motor; health; subject-practical, technological; sensory-cognitive, logical-mathematical, research; natural-ecological; socio-civil; speech; digital; speech in the plane of mastering the basics of literacy, in the field of foreign language, financial literacy, etc.), which must be formed in preschool children according to the Basic component of preschool education (State Standard of Preschool Education) [31], allow to state the effectiveness of the use of AR technology in preschool education. Also, the use of AR technology in the educational process can affect the effectiveness of skills that are common to preschool and primary education (express creativity

and initiative; manage emotions; express and justify one’s own opinion; think critically; make decisions; solve problems; cooperate in a team, etc.) and promote continuity between preschool and primary education.

Preschoolers should be introduced to augmented reality by coloring “Live Notepad” with the 3D Artist application, which turns a painted picture into a dimensional 3D image. It is methodically assumed that first children paint pictures (dragon, car, house, etc.), and then download a special AR-application and through the camera of the mobile gadget watch how painted objects come to life. We also consider 3D coloring pages by Devar Ukraine with the free Devar Kids application from the AppStore or Google Play to be interesting for preschool and primary school children. With the help of coloring pages and AR-application, you can create a small cartoon with your child. Popular is a series of coloring pages with augmented reality Live Coloring with the appropriate application from the Google Play resource for the Android operating system. This application has coloring pages that can be printed out on a printer, which is convenient for the teacher. Valuable from a pedagogical point of view is that these coloring pages are divided into topics: professions (builder, cook, teacher, farmer, scientist, firefighter, astronaut), sea animals (dolphin, shark, octopus, starfish, crab, turtle), dinosaurs etc. It is important that augmented reality allows you to see the character exactly as it was created by the child (figure 1). All colors and patterns are accurately reproduced by the program in augmented reality. These interactive 3D coloring pages become not only an exciting adventure, but also contribute to the development of emotional intelligence, speech and creativity of preschoolers.

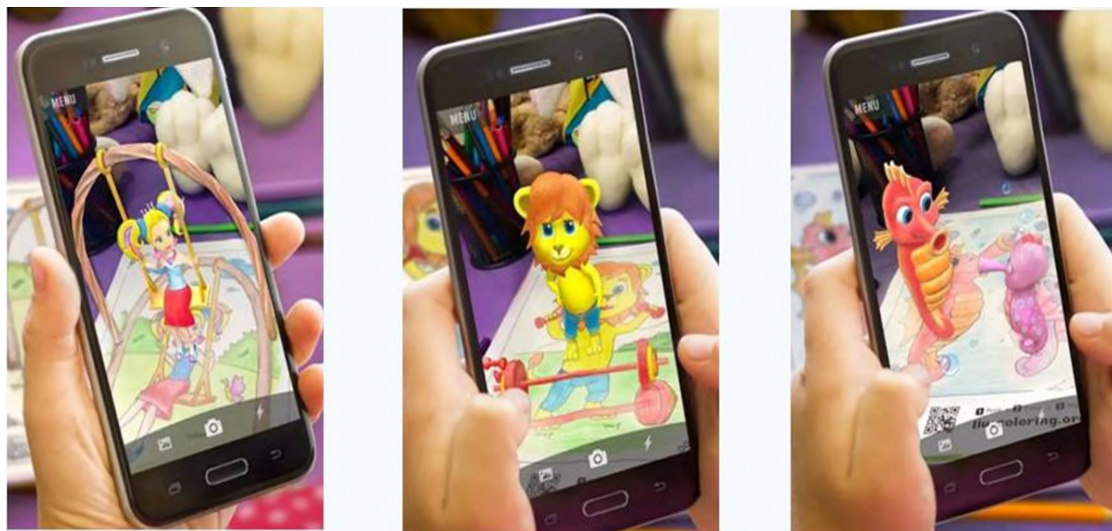

Figure 1: Activation of coloring pages with augmented reality Live Coloring.

In the play activities of preschoolers there is an opportunity to use an interactive game set “Animal Cube”, which consists of soft toys (monkey, elephant, parrot, panda) with a special cube. By scanning the cube corresponding to one of the toys with the help of the Varus Animal Cube mobile application on the Play Market and App Store platforms, the educator activates

the game of preschoolers with a virtual animal that “lives” inside. Children can enter the reality of their pet and observe the wonders of wildlife, as well as explore the 3D habitat of exotic animals with ARKit or ARCore. Each of the four groups of preschoolers can look after the animal selected from the play set, learn how to take care of the animal: feed it, train, decorate, play and actively interact with it (figure 2). Teachers of preschool education institutions can organize the activities of preschoolers to take care in the virtual world of exotic animals that are endangered in their natural habitat. Thus the tasks of game, sensory-cognitive and research activity for acquaintance with animals are realized.

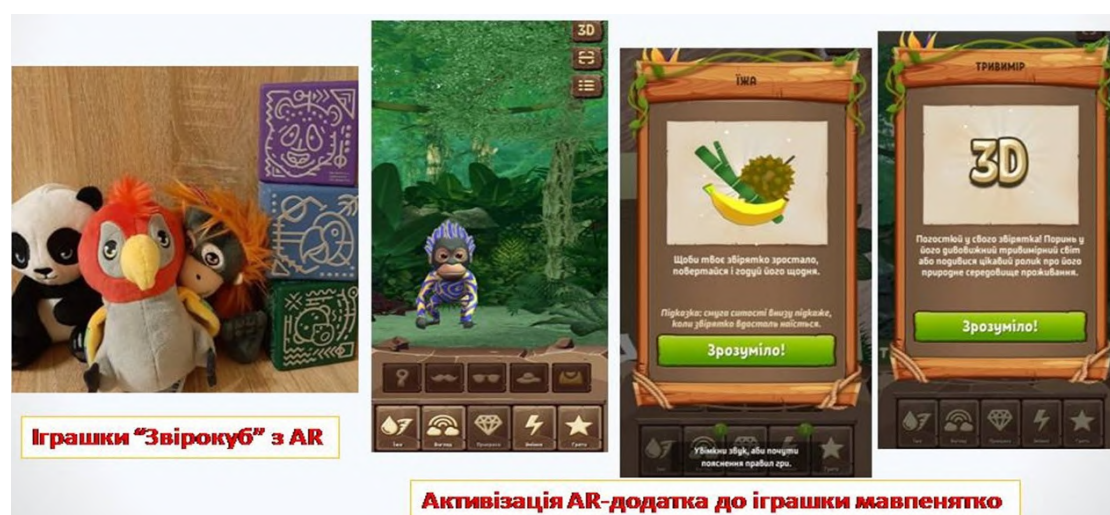

Figure 2: Activation of augmented reality of the game set “Animal Cube”.

In preschool and primary education institutions for educational and developmental purposes one should use a series of books “My creative encyclopedia. The world is waiting for the opening” of the “Ranok” Ukrainian publishing house. In this series, one has created such interactive books as “I am an inventor”, “I want to know everything”, “I want to be able to do everything”, “I am studying “what?” and “how?”. Interactive encyclopedias for children are aimed at developing their creativity to implement their own project. Each of these editions provides independent assembly of the designer with original 3D models, and the book is used as a podium for the designer with a special field where it is possible to place all collected 3D elements. In particular, the encyclopedia “I am an inventor” is about creativity and paper arts, such as origami, quilling, vytynanka, also tells about the model and its creation, how a 3D printer works, how to bring images to life. After reading the information about the balloon, the child has the opportunity to create its 3D model and use the QR code to download the AR application, which will revive the model collected by the child (figure 3). The encyclopedia “I want to be able to do everything” provides information about painting, architecture, the world of computers, the boundless Internet, smart devices and offers to create a 3D model of a wind turbine. It is useful for preschoolers and younger students to work on the project both individually and in groups. The purpose of the characterized encyclopedias is to translate the

initial knowledge of modeling, techniques and technologies, types of arts and crafts, i.e. what the future inventor needs to know.

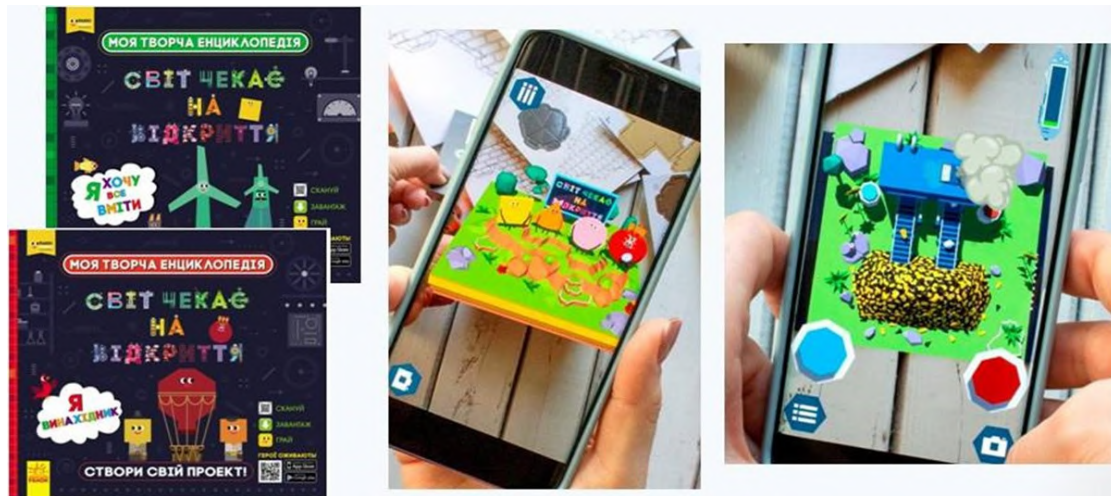

Figure 3: Activation of augmented reality in the book “My creative encyclopedia”.

The use of augmented reality book “The Bun” in work with young preschool children contributes to the formation of certain components of sensory-cognitive, logical-mathematical competencies – readiness to direct sensory processes (sensation, perception, attention, etc.) to the knowledge of environmental objects; formation of ideas about the basic mathematical concepts “number”, “magnitude”, “shape”, “space”, “time”, “color”, etc.

With the help of the book “Kobzar’s Alphabet”, which contains works of Taras Shevchenko for each letter of the alphabet, illustrations to which come to life, move and talk with the free application FastAR Kids in smartphones or tablets (iOS, Android, iPhone), one can form in preschoolers such components of speech competence as understanding that in Ukraine the Ukrainian language is the state language; awareness of the sound composition of the native language, based on the developed phonemic hearing and speech breathing; to cultivate love for the native language, respect for the state language, languages of representatives of national minorities of Ukraine, etc.

The use of augmented reality books in the educational process (Hans Christian Andersen’s fairy tales “Wild Swans”, “Snow Queen”, Charles Perrault’s “Sleeping Beauty”, “Cat in Boots”, etc.) determines the possibility of forming in older preschool children various components of social and civic competence (interest in universal values, communication values; knowledge of the meaning, essence, specific manifestations of personal qualities (independence, responsibility, diligence, leadership), initiative, activity, creativity, etc. in interaction with other people; awareness of the norms of behavior in everyday life, etc.). The use of these and other editions of works of art by Ukrainian and foreign writers with AR applications in primary school is discussed in the study of Nezhyva et al. [30].

The use of AR is also aimed at the formation of digital competence in preschoolers and primary school children – the formation of ideas about information and communication and digital

technologies as modern technical means that expand the information horizons and help navigate the world in high technology; formation of the ability to use information and communication and digital technologies to meet one's own individual needs and solve educational, gaming tasks based on the acquired basic knowledge, skills, positive attitude, interest in computer and digital technology (smartphone, computer, tablet) etc.

At the same time, the results of the analysis of theory and practice indicate the presence of a number of problems in the application of AR in the educational process of modern domestic preschool and primary education. Thus, despite the fact that preschoolers in modern society are accustomed to a variety of gadgets (smartphones, tablets, etc.), which are gradually becoming one of the important means of learning about the environment, most do not have the skills to operate gadgets at home and in the educational process. There is a shortage of mobile AR applications for visualization of experiences that need to be learned by children in early childhood and primary education. The use of gadgets by preschoolers and junior schoolchildren is quite rightly limited by a number of sanitary and hygienic restrictions, based on the features of physical, psychological and emotional development of children of this age.

3. Results of the study

In order to verify the results obtained during the theoretical study, an empirical study was conducted. The study involved a group of undergraduate students majoring in "Preschool Education", as well as a group of undergraduate students majoring in "Primary Education" (87 full-time and part-time students) of the Pedagogical Institute of Borys Grinchenko Kyiv University. Questionnaires and diagnostic tasks were used as research methods. The content of the questionnaire questions, tasks were determined on the basis of studying and analyzing the theory and practice of using AR in the field of education.

The content of the questionnaire questions for undergraduate students was as follows:

1. How do you understand the concept of "augmented reality technology"?
2. What tools with augmented reality technologies for teaching and educating preschoolers (junior high school students) do you know?
3. Do you plan to use augmented reality technology in your professional activities?
4. What, in your opinion, is the essence of the concept of "the ability of teachers to use augmented reality in the educational process of preschool (primary) education"?
5. How effective do you consider the educational process in shaping the ability of future teachers to use augmented reality in the educational process of preschool education institutions?

The content of the diagnostic task for undergraduates majoring in "Preschool Education" was defined as follows: "Develop a synopsis of an integrative lesson for older preschool children in any educational field of the Basic component of preschool education ("Child in the sensory-cognitive space", "Child in the natural environment", "Child in the society", "Speech of the child", etc.) using AR technology for the purpose of visual modeling of educational material, supplementing it with clarity. Identify and justify the use of augmented reality technology. Create a model for using AR. Identify mobile applications for visualization of educational

material and gadgets that are appropriate to operate. Implement the synopsis in the educational practice of the preschool institution”.

The content of the diagnostic task for undergraduates majoring in “Primary Education” was defined as follows: “Develop an outline of an integrated literacy lesson for 1st grade students (or literary reading for 2nd-4nd grade students) using AR technology. Identify and justify the use of augmented reality technology. Create a model for using AR. Identify mobile applications for visualization of educational material and gadgets that are appropriate to operate. Implement the synopsis in the educational practice of primary school”.

The essence of the basic concept of the study “readiness of teachers to use augmented reality in the educational process of preschool and primary education” we have defined as a holistic, integrated, complex content of personality, which is a set of values, motives, knowledge, skills, personality professional qualities that determine the effectiveness of augmented reality in professional teaching.

Based on the analysis of the scientific literature in order to identify the level of development of the readiness of future teachers of preschool and primary education institutions to use AR, the criteria were determined, which are revealed through the indicators defined by us.

Motivational criterion with indicators: identification of interest in new technologies, the need to study AR and the desire to use it in the educational process; desire to use the trends of modern education, to achieve effective results in professional activities, the desire for creative search.

Cognitive criterion with the indicator: knowledge of augmented reality technology, teaching aids in preschool and primary education with AR applications, the content of the concept of “readiness of teachers to use augmented reality in the educational process of preschool and primary education”.

Activity criterion with indicators: ability to develop a synopsis of an integrative lesson for children of preschool (primary school) age in any educational field with the use of AR; determine and justify the use of AR; develop a model of AR application; identify mobile applications for visualization of educational material; choose gadgets that are appropriate to operate; to implement the synopsis in educational practice.

After analyzing the answers of undergraduates to the third, fourth and fifth questions, three levels of development of the motivational component of the readiness of future teachers to use AR in the educational process were identified. Sufficient level indicates the interest of students in the study of AR technologies, the desire for creative use of augmented reality teaching aids in the educational process, the desire to achieve effective results of educational activities with the help of AR. The average level is found in students who understand the importance of using AR in the educational process, but without much interest in new knowledge. The low level indicates a lack of motivation to master the technology of augmented reality and a lack of understanding of the importance and specificity of the use of these technologies in the professional activities of educators and primary school teachers.

According to the results of the analysis of the answers to the first, second and fourth questions of the questionnaire, the undergraduate students were divided into three groups according to the levels of development of their cognitive component of readiness to use AR in the educational process. A sufficient level was found in students who in the content of the studied concept determine: the main components of readiness to use AR in the educational process (knowledge,

skills); the essence of the concept of “augmented reality” as a process (“augmented reality by any virtual elements”; “use of the environment, over which a certain part of virtual information is superimposed”; “introduction into the field of perception of any sensory data”, etc.); the purpose of using AR in preschool and primary education. The average level of development of the cognitive component was found in students who in the content of the studied concept do not define reliably or do not name one or more of the main components of teachers’ readiness to use AR in the educational process. Low level was found in students who in the content of the studied concept do not define any of the main components of the teacher’s ability to use AR in the educational process; do not understand the essence of the concept of “augmented reality”, do not formulate the purpose of the use of AR in preschool and primary education.

Thus, the analysis of the results of the study of the level and features of the development of the ability of future teachers to use AR in the educational process of preschool and primary education allows us to show the following. A sufficient level of development of the motivational component of the ability to use AR in the educational process was found in 12 surveyed students, an average level was found in 34 respondents, and a low level of development of this component was found in 41 respondents. A sufficient level of development of the cognitive component of the ability to use AR in the educational process was found in 9 surveyed students, an average level was found in 30 respondents, and a low level of development of this component was found in 48 respondents (table 1).

Table 1

Quantitative indicators of levels of development of motivational, cognitive, activity components of readiness of undergraduates to use of AR in educational process

Levels of development of readiness of future teachers of to use AR	Sufficient level		Average level		Low level	
	Quantity	%	Quantity	%	Quantity	%
Motivational component	12	13.8	34	39.1	41	47.1
Cognitive component	9	10.3	30	34.5	48	55.2
Activity component	11	12.6	32	36.8	44	50.6

Analysis of the answers to the fifth question of the questionnaire allows us to state that 21 respondents consider the educational process to form the ability of future teachers to use AR in the educational process of preschool and primary education institutions effective; 42 respondents – not effective enough; 24 respondents – ineffective.

According to the results of the analysis of the diagnostic task, students were divided into three groups according to the levels of development of their activity component of readiness to use AR in the educational process. Thus, a sufficient level was found in students who methodically correctly developed a synopsis of integrative classes for preschoolers (junior high school students) in any educational field with the use of AR; identified and justified the feasibility of using AR technology; created a model of AR application; identified mobile applications for visualization of educational material and gadgets that should be used; methodically expediently implemented the developed synopsis in educational practice. The average level of development of the activity component of readiness was found in students who made methodological mistakes in developing a syllabus for preschoolers (junior high school students) with the use of AR and

the model of AR; did not sufficiently convincingly determine and substantiate the feasibility of using AR; had difficulties in the process of implementing the synopsis in educational practice. The low level is characteristic of students who could not methodically develop a synopsis of integrative lessons for preschoolers (junior high school students) with the use of AR; did not implement classes with the use of AR in the educational process.

Quantitative ratios of levels of development of motivational, cognitive, activity component of readiness to use AR in the educational process of preschool and primary education institutions in students of the Pedagogical Institute of Borys Grinchenko Kyiv University are presented in table 1.

As a result of diagnosing the readiness of future teachers to use AR in the educational process of preschool and primary education institutions, it was found that according to certain criteria, most students (average 87.7%) have a medium and low level. Low indicators were established for cognitive (10.3%) and activity (12.6%) criteria. Thus, future teachers need additional knowledge and skills to carry out such activities, including knowledge of the theoretical basis of AR, the variety and specifics of augmented reality teaching aids, methods of using AR in preschool education, ways to organize children in practice with AR applications. We consider it positive that 52.9% of students showed interest in new technology in education and a desire to implement it in practice, which indicates the presence of positive motivation of future teachers to organize and establish the use of AR technology, to understand the importance of introducing innovative tools in the education of preschoolers and primary school children. Indicators of the levels of development of readiness for the use of AR in the educational process of preschool and primary education institutions in students of the Pedagogical Institute are shown in the diagram in % (figure 4).

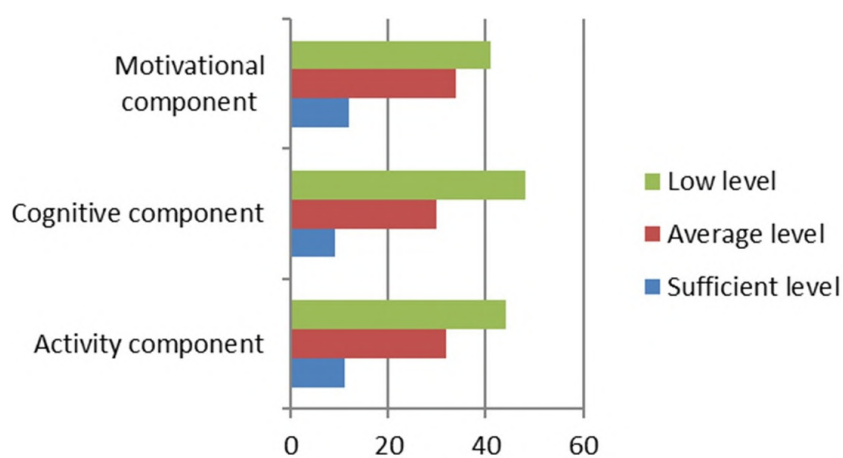

Figure 4: Indicators of levels of development of readiness to use AR in the educational process of preschool and primary education institutions for undergraduates (%)

Therefore, the results of the diagnostic study indicate a significant number of future teachers who have a medium and low level of readiness to use AR in the educational process of preschool and primary education and necessitate the formation of the studied readiness in university pedagogical training.

Based on the results of the analysis of scientific sources on the application of AR in education and the results of diagnostic research, we have developed a model of forming the readiness of future teachers to use AR in the educational process of preschool and primary education. Such integration is due to the presence of related specialties at the Pedagogical Institute of Borys Grinchenko Kyiv University (013 specialty “Primary Education”, specialization 012 “Preschool Education”, also 012 specialty “Preschool Education”, specialization 013 “Primary Education”). The leading idea is the organization of work of teachers of pedagogical institutes on formation of readiness of students for application of the augmented reality in educational process. The realization of this goal requires the solution of the following tasks: to form the motivation of teachers, understanding the importance of the application of augmented reality technology in professional activities; to expand and deepen students’ knowledge about the specifics of AR, a variety of educational tools with AR applications; to promote the mastery of techniques for working with learning tools with AR, ways to organize children when working with AR applications. The model consists of the following stages: cognitive (study and analysis of scientific sources on the research problem; defining the essence of the basic concept of research “readiness of teachers to use augmented reality in the educational process of preschool and primary education” in its components; analysis of curricula and work programs disciplines of a number of domestic pedagogical universities in order to identify disciplines aimed at the formation of the studied readiness); activity (study of the current state of readiness of future teachers to use AR in professional activities; development of the content module “Fundamentals of readiness of teachers to use AR in the educational process of preschool (primary) education” (lectures, practical and laboratory classes, independent work and formative assessment); introduction of this module to the content of the discipline “Methods of teaching professional disciplines” for the preparation of masters in the specialty “Preschool Education”, “Primary Education”); creative (development of master classes, trainings, webinars, quests on the problem of application of augmented reality technology in the educational process of preschool and primary education). Schematically developed model is presented in figure 5.

4. Problems and prospects

The results of the analysis of the theory and practice of preschool and primary education indicate the presence of a number of problems in the application of AR in the educational process of modern educational institutions. Thus, despite the fact that preschoolers and younger students in modern society are accustomed to a variety of gadgets (smartphones, tablets, etc.), most do not have the skills to operate them in the educational process. There is a shortage of mobile AR applications for visualization of experience, which must be learned by children in early childhood and early school age.

The analysis of the results of diagnostic research and observation of pedagogical practice in the conditions of preschool and primary education institutions allows to outline the following problems: insufficient formation of the studied readiness of future teachers in a certain field; inconsistency between the peculiarities of training future teachers to use AR technology in professional activities and modern requirements for the quality of the educational process; insufficient training of teachers for the formation of the studied readiness in the conditions of

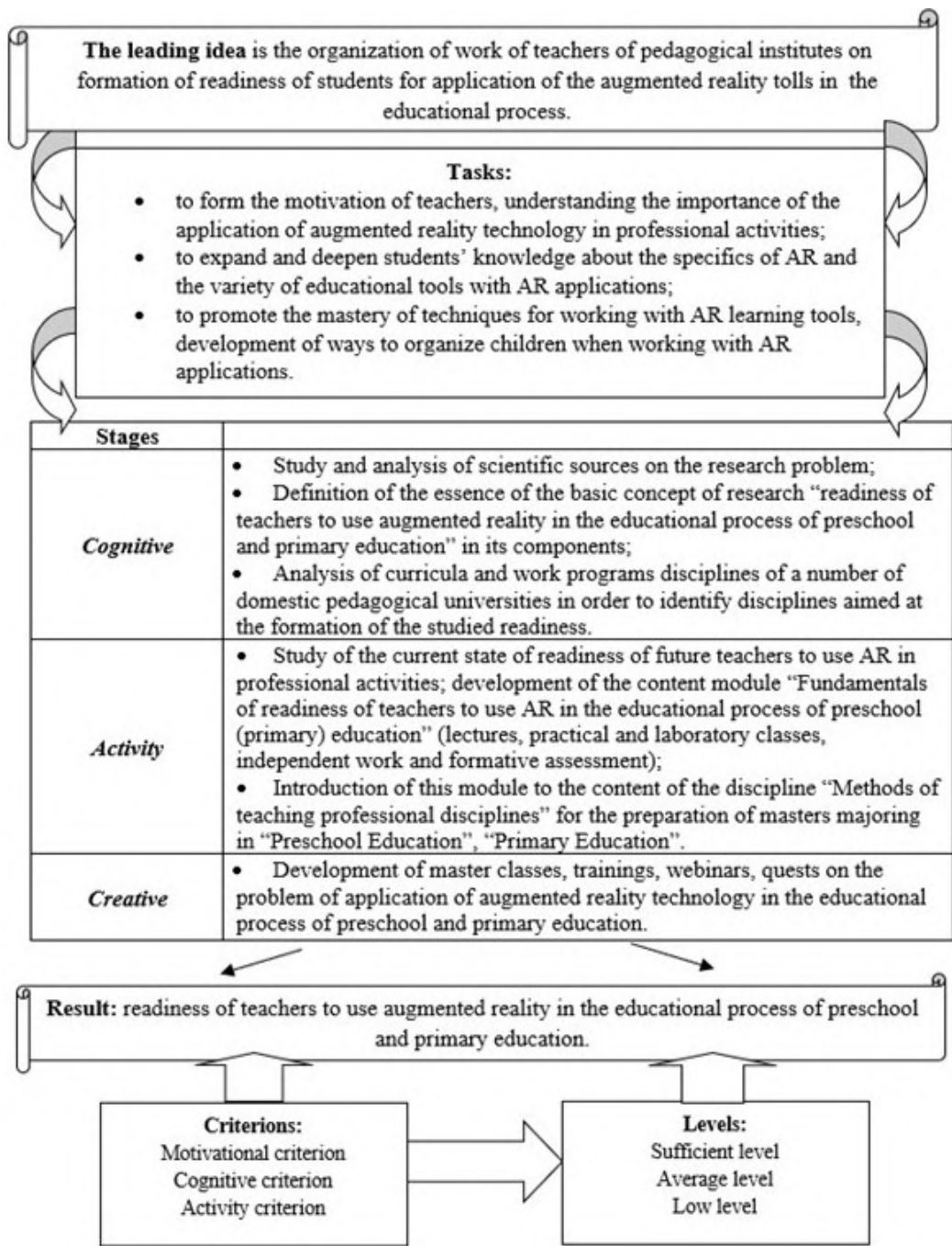

Figure 5: Model of formation of readiness of future teachers to use AR in educational process of institutions of preschool and primary education.

higher education institutions; the need to develop and implement a holistic system of formation of the studied readiness of future teachers in the conditions of higher pedagogical education.

Prospects for further research are to develop scientific and methodological support for the formation of the readiness of future teachers to apply augmented reality in preschool and primary education; preparation of generalized results of experimental work of scientific and methodical recommendations on the researched problem.

In order to ensure the effectiveness of the system of formation of readiness for the introduction of AR by future teachers in preschool and primary education, it is planned to use an innovative class created at the Pedagogical Institute of Borys Grinchenko Kyiv University, which is designed as an innovative educational center for training future teachers, formation of their innovative competence, implementation of STEAM-education tasks [32]. The innovative class is equipped with computers, an interactive whiteboard, a projector and a multifunctional device – printer, scanner, copier, as well as digital means – laptops, tablets, electronic flipchart, interactive whiteboards and projectors, 3D printers (XYZprinting) with laser engraving module, etc.

5. Conclusions

In the conditions of informatization of society, computerization and introduction of modern technologies into the educational process, the problem of application of digital technologies has become a leading one in pedagogical theory and practical activity of educational institutions of Ukraine. Therefore, it is time to prepare future teachers for the use of AR technology in the educational process of preschool and primary education. The study identified the relevance of the application of AR technology for the effective education of preschoolers and primary school children. Scientific sources on the problem of AR application in the field of education are analyzed. Problems in the application of AR in the educational process of modern domestic preschool and primary education institutions are outlined. Possibilities of using augmented reality technology in work with preschoolers and junior schoolchildren are considered. The specifics of teaching aids and publications of works of art with AR applications, which are appropriate to use in working with preschoolers and younger students, are analyzed. The possibilities of alphabets created with the help of AR, creative encyclopedias, coloring books, educational games for children are characterized.

The current state of readiness of future teachers to use AR in professional educational activities is studied. For this purpose the following methods were used: questionnaire, diagnostic task in order to study the state of formation of the studied readiness; description of factual information for the purpose of analytical interpretation and study of specific facts and phenomena; quantitative processing of research results.

It is concluded on the insufficiency of the formation of a certain readiness of future teachers in the field of preschool and primary education; inconsistency between the peculiarities of training future teachers to use AR technology and modern requirements for the quality of the educational process; the need to develop and implement a holistic system of formation of the studied readiness of future teachers in the conditions of institutions of higher pedagogical education. The model of formation of readiness of future teachers to use AR in educational process of establishments of preschool and primary education is developed: the leading idea, tasks, criteria and levels of the defined readiness, stages, forms of the organization of educational process are defined.

References

- [1] M. Popel, M. Shyshkina, The cloud technologies and augmented reality: The prospects of use, *CEUR Workshop Proceedings 2257* (2018) 232–236.
- [2] L. Panchenko, I. Muzyka, Analytical review of augmented reality MOOCs, *CEUR Workshop Proceedings 2547* (2020) 168–180.
- [3] L. Panchenko, T. Vakaliuk, K. Vlasenko, Augmented reality books: Concepts, typology, tools, *CEUR Workshop Proceedings 2731* (2020) 283–296.
- [4] I. Mintii, V. Soloviev, Augmented reality: Ukrainian present business and future education, *CEUR Workshop Proceedings 2257* (2018) 227–231.
- [5] D. S. Shepiliev, S. O. Semerikov, Y. V. Yechkalo, V. V. Tkachuk, O. M. Markova, Y. O. Modlo, I. S. Mintii, M. M. Mintii, T. V. Selivanova, N. K. Maksyshko, T. A. Vakaliuk, V. V. Osadchyi, R. O. Tarasenko, S. M. Amelina, A. E. Kiv, Development of career guidance quests using WebAR, *Journal of Physics: Conference Series 1840* (2021) 012028. doi:10.1088/1742-6596/1840/1/012028.
- [6] R. O. Tarasenko, S. M. Amelina, S. O. Semerikov, V. D. Shynkaruk, Using interactive semantic networks as an augmented reality element in autonomous learning, *Journal of Physics: Conference Series 1946* (2021) 012023. doi:10.1088/1742-6596/1946/1/012023.
- [7] O. Prokhorov, V. Lisovichenko, M. Mazorchuk, O. Kuzminska, Developing a 3D quest game for career guidance to estimate students' digital competences, *CEUR Workshop Proceedings 2731* (2020) 312–327.
- [8] A. Iatsyshyn, V. Kovach, Y. Romanenko, I. Deinega, A. Iatsyshyn, O. Popov, Y. Kutsan, V. Artemchuk, O. Burov, S. Lytvynova, Application of augmented reality technologies for preparation of specialists of new technological era, *CEUR Workshop Proceedings 2547* (2020) 181–200.
- [9] T. Kramarenko, O. Pylypenko, V. Zaselskiy, Prospects of using the augmented reality application in STEM-based Mathematics teaching, *CEUR Workshop Proceedings 2547* (2020) 130–144.
- [10] O. Lavrentieva, I. Arkhypov, O. Krupskyi, D. Velykodnyi, S. Filatov, Methodology of using mobile apps with augmented reality in students' vocational preparation process for transport industry, *CEUR Workshop Proceedings 2731* (2020) 143–162.
- [11] P. Nechypurenko, V. Stoliarenko, T. Starova, T. Selivanova, O. Markova, Y. Modlo, E. Shmeltser, Development and implementation of educational resources in chemistry with elements of augmented reality, *CEUR Workshop Proceedings 2547* (2020) 156–167.
- [12] N. Rashevskaya, V. Soloviev, Augmented reality and the prospects for applying its in the training of future engineers, *CEUR Workshop Proceedings 2257* (2018) 192–197.
- [13] A. Striuk, M. Rassovytska, S. Shokaliuk, Using Blippar augmented reality browser in the practical training of mechanical engineers, *CEUR Workshop Proceedings 2104* (2018) 412–419.
- [14] S. Zelinska, A. Azaryan, V. Azaryan, Investigation of opportunities of the practical application of the augmented reality technologies in the information and educative environment for mining engineers training in the higher education establishment, *CEUR Workshop Proceedings 2257* (2018) 204–214.
- [15] N. Zinonos, E. Vihrova, A. Pikilnyak, Prospects of using the augmented reality for train-

- ing foreign students at the preparatory departments of universities in Ukraine, CEUR Workshop Proceedings 2257 (2018) 87–92.
- [16] P. Nechypurenko, T. Starova, T. Selivanova, A. Tomilina, A. Uchitel, Use of augmented reality in chemistry education, CEUR Workshop Proceedings 2257 (2018) 15–23.
- [17] N. Rashevskaya, S. Semerikov, N. Zinonos, V. Tkachuk, M. Shyshkina, Using augmented reality tools in the teaching of two-dimensional plane geometry, CEUR Workshop Proceedings 2731 (2020) 79–90.
- [18] T. Kolomoiets, D. Kassim, Using the augmented reality to teach of global reading of preschoolers with autism spectrum disorders, CEUR Workshop Proceedings 2257 (2018) 237–246.
- [19] M. Billinghamurst, Augmented reality in education, *New horizons for learning* 12 (2002) 1–5. URL: http://www.solomonalexis.com/downloads/ar_edu.pdf.
- [20] M. Kesim, Y. Ozarslan, Augmented reality in education: Current technologies and the potential for education, *Procedia - Social and Behavioral Sciences* 47 (2012) 297–302. doi:10.1016/j.sbspro.2012.06.654.
- [21] K. Dutta, Augmented reality for e-learning, 2015. URL: https://www.researchgate.net/publication/304078112_Augmented_Reality_for_E-Learning.
- [22] O. Syrovatskyi, S. Semerikov, Y. Modlo, Y. Yechkalo, S. Zelinska, Augmented reality software design for educational purposes, CEUR Workshop Proceedings 2292 (2018) 193–225. URL: <http://ceur-ws.org/Vol-2292/paper20.pdf>.
- [23] V. Tkachuk, Y. Yechkalo, S. Semerikov, M. Kislova, Y. Hladyr, Using Mobile ICT for Online Learning During COVID-19 Lockdown, in: A. Bollin, V. Ermolayev, H. C. Mayr, M. Nikitchenko, A. Spivakovsky, M. Tkachuk, V. Yakovyna, G. Zholtkevych (Eds.), *Information and Communication Technologies in Education, Research, and Industrial Applications*, Springer International Publishing, Cham, 2021, pp. 46–67.
- [24] O. Bondarenko, O. Pakhomova, W. Lewoniewski, The didactic potential of virtual information educational environment as a tool of geography students training, CEUR Workshop Proceedings 2547 (2020) 13–23.
- [25] G. Salvador-Herranz, D. Pérez-López, M. Ortega, E. Soto, M. Alcañiz, M. Contero, Manipulating virtual objects with your hands: A case study on applying desktop augmented reality at the primary school, in: 2013 46th Hawaii International Conference on System Sciences, 2013, pp. 31–39. doi:10.1109/HICSS.2013.390.
- [26] B. Parhizkar, W. K. Obeidy, S. A. Chowdhury, Z. Mohana Gebril, M. N. A. Ngan, A. Habibi Lashkari, Android mobile augmented reality application based on different learning theories for primary school children, in: 2012 International Conference on Multimedia Computing and Systems, 2012, pp. 404–408. doi:10.1109/ICMCS.2012.6320114.
- [27] L. Midak, I. Kravets, O. Kuzyshyn, J. Pahomov, V. Lutsyshyn, A. Uchitel, Augmented reality technology within studying natural subjects in primary school, CEUR Workshop Proceedings 2547 (2020) 251–261.
- [28] N. Osipova, H. Kravtsov, O. Hniedkova, T. Lishchuk, K. Davidenko, Technologies of virtual and augmented reality for high education and secondary school, CEUR Workshop Proceedings 2393 (2019) 121–131.
- [29] A. Bessarab, *Technologii dopovnenoj realnosti yak novyi trend y formyvanni kultury chytannya* [Augmented reality technologies as a new trend in the formation of reading

- culture], Series: Social Communications (2016) 4–8.
- [30] L. Nezhyva, S. Palamar, O. Lytvyn, Perspectives on the use of augmented reality within the linguistic and literary field of primary education, CEUR Workshop Proceedings 2731 (2020) 297–311.
- [31] Bazovyi component doshkilnoi osvity v Ukraini (Derzhavnyi standard doshkilnoi osvity) [Basic component of preschool education in Ukraine (State standard of preschool education)]. New edition. Order of the Ministry of Education and Science № 33 of January 12, 2021, 2021. URL: <https://osvita.ua/legislation/doshkilna-osvita/79142/>.
- [32] N. Morze, V. Vember, M. Boiko, L. Varchenko-Trotsenko, Organization of STEAM lessons in the innovative classroom, Open educational e-environment of modern University (2020). doi:10.28925/2414-0325.2020.8.9.